

USER MANUAL TESSERA PROCESSING

Tessera version: 2.2

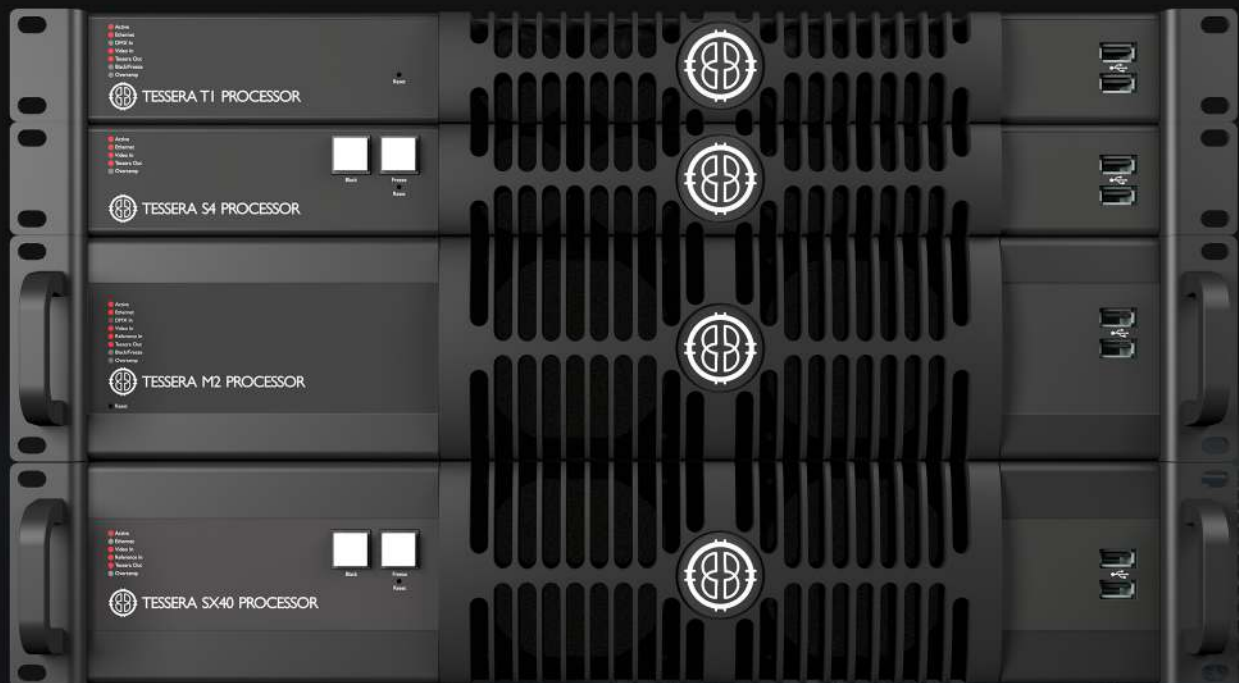

CONTENTS

Chapter 1 - Introduction	3
Chapter 2 - General Overview	4
Tessera SX40 LED Processor	7
Tessera XD Distribution Unit	9
Tessera M2 LED Processor	11
Tessera S4 LED Processor	13
Tessera T1 LED Processor	15
Chapter 3 - Quickstart	17
Chapter 4 - System Configuration	21
Redundancy Configuration	22
Output Capacity	27
Combining Processors	29
Chapter 5 - Tessera Management Software	30
Chapter 6 - Project Setup	38
Chapter 7 - Fixtures	46
Adding Fixtures To A Project	53
Sub-fixtures	59
Understanding Topology And Association	66
Fixture Layout	72
Chapter 8 - Main Project Screen	77
Canvas View	77
Presets	89
Log	93
Moving Around The Canvas	94
Project Data Export	95
Online View	96
Topology View	98
Chapter 9 - Inputs	99
Input Colour Control	102
Histograms	103
Chapter 10 - Processing	107
Active Area	112
ChromaTune	115
Chapter 11 - Test Patterns	120
Chapter 12 - Global Colour	124
Dark Magic	126
Low End Boost	128
Studio Mode	129
On-Screen Colour Adjustment	130
Chapter 13 - Network	142
Chapter 14 - Live Control	145
DMX Control	152
EDMX Control	153
Tessera Control	154
Chapter 15 - Processor Settings	155
Security	159
Date And Time	160
Fixture Library	161
Preferences	166

Crash Management	168
Restore Factory Settings	169
Format Internal Storage	170
Reload Firmware	171
Processor Status	172
About	173
Appendix A - Keyboard Shortcuts	174
Appendix B - Cable Requirements For Tessera SX40 And XD	177
Appendix C - Setting IP Addresses	179
Appendix D - DMX Channel Allocations	183
Appendix E - Warranty	187
Glossary	188

CHAPTER 1 - INTRODUCTION

COPYRIGHT

©2012 - 2019 Brompton Technology Ltd. All rights reserved.

TRADEMARKS

Brompton is a registered trademark owned by Carallon Ltd.

All other brand and product names used in this document may be trademarks, registered trademarks or trade names of their respective holders.

CHANGES

The information and specifications contained within this document are subject to change without notice. Brompton Technology Ltd reserves the right to make improvements and changes to the hardware and software described in this document at any time and without notice.

Brompton Technology Ltd assumes no responsibility or liability for any errors or inaccuracies that might occur in this document.

ABOUT THIS MANUAL

This manual provides all the information required for the correct and safe use of the Tessera processors and the supplied software.

This revision of the manual was written for Tessera software version: 2.2 published on: 04/06/2019

ABOUT THE TESSERA SYSTEM

The Tessera system comprises processors, distribution units, receiver cards and software. These elements can be used with a wide range of LED fixtures.

Brompton Technology partners with both purchasers and manufacturers who wish to use Brompton processing to control their LED video products.

For more information about Brompton Technology please contact: info@bromptontech.com

HANDLING AND SAFE OPERATION

The Tessera processors and distribution units are packaged in a rugged custom-designed 19" rack mounting case with integral mounting handles.

The processor should be adequately supported in a rack at all times. The weight of the processor should never be supported entirely on the rack ears as this can lead to distortion, especially if the rack is roughly handled.

The processors and distribution units should only be opened by professionals as it will expose the user to potentially dangerous voltages. The units must never be operated with the cover removed. Opening the units without an approval from Brompton Technical Support will invalidate the warranty. The product is designed to operate from a grounded power source between 100 and 250V AC, 47 -63Hz. Ensure the use of a stable power source. If your power source is prone to surges, place the unit on an uninterruptible power supply (UPS) to prevent exposure to voltages that could potentially damage the system.

CHAPTER 2 - GENERAL OVERVIEW

GENERAL

Brompton Technology makes a variety of Tessera LED video processors for different applications.

Tessera SX40 is currently our highest capacity processor, able to support a nominal 9 million pixels and 4K canvas resolutions with HDMI 2.0 and 12G SDI inputs. Four 10 Gigabit ports allow data transfer using fibre or CAT6 copper cable. The SX40 can support up to 2000 connected fixtures and offers maximum flexibility with the use of the XD distribution system.

Please note: sub-fixtures are supported on Tessera SX40 from firmware version 2.3 and upwards.

Tessera M2 is the most powerful processor to drive HD content. It can control a nominal 2 million pixels over four 1 Gigabit outputs to a fixture count of up to 2000. Supports 3G-SDI and DVI-I inputs.

Tessera S4 processor is ideal for high resolution screens. The S4 processor does not have the front-side processing, scaling or degree by degree rotation of the T1 and the M2 but can control the same number of pixels across four Gigabit outputs as the M2.

Tessera T1 is ideal for creative shows requiring flexibility over number of fixtures. It has a DVI-D input and supports a capacity of 0.5 million pixels in an HD canvas. The T1 includes most of the main features available with the Tessera systems, with one output port supporting up to 500 fixtures.

SYSTEM OVERVIEW

The Tessera system can be controlled locally using a monitor, keyboard and mouse connected directly to a Tessera processor. Alternatively, you can use the Tessera Remote software on a Windows PC or Mac connected to the processor via a Gigabit Ethernet network. The Tessera Remote software can be used in Offline Editor mode, to allow preparation of project files without a processor.

The processors have an integral DisplayPort (DP++) output and USB ports for local control and monitoring. Each Tessera output can be distributed using standard Gigabit Ethernet switches or fibre optic transceivers.

SYSTEM SETUP DIAGRAM: TESSERA M2

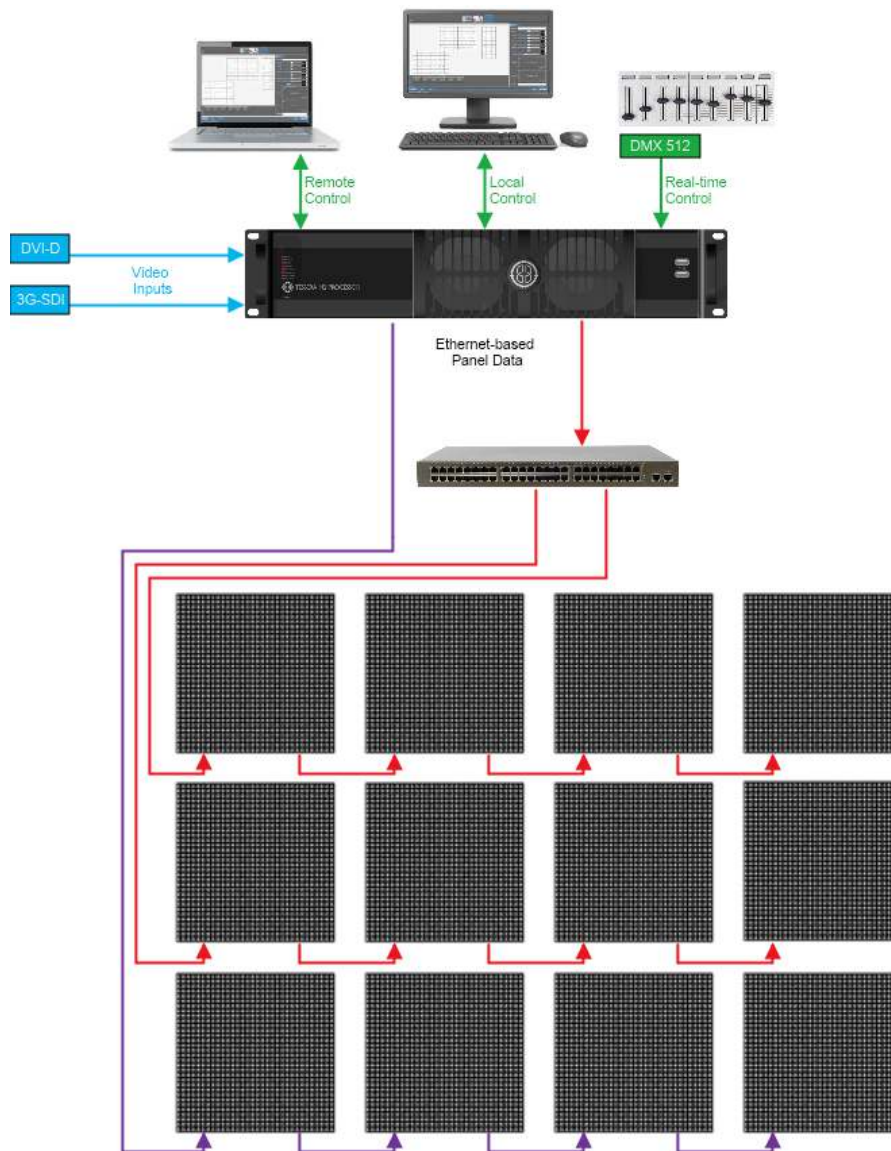

Figure 2-1. Typical system set-up for a M2 processor (A similar diagram can be applied to S4 and T1)

SYSTEM SETUP DIAGRAM: TESSERA SX40

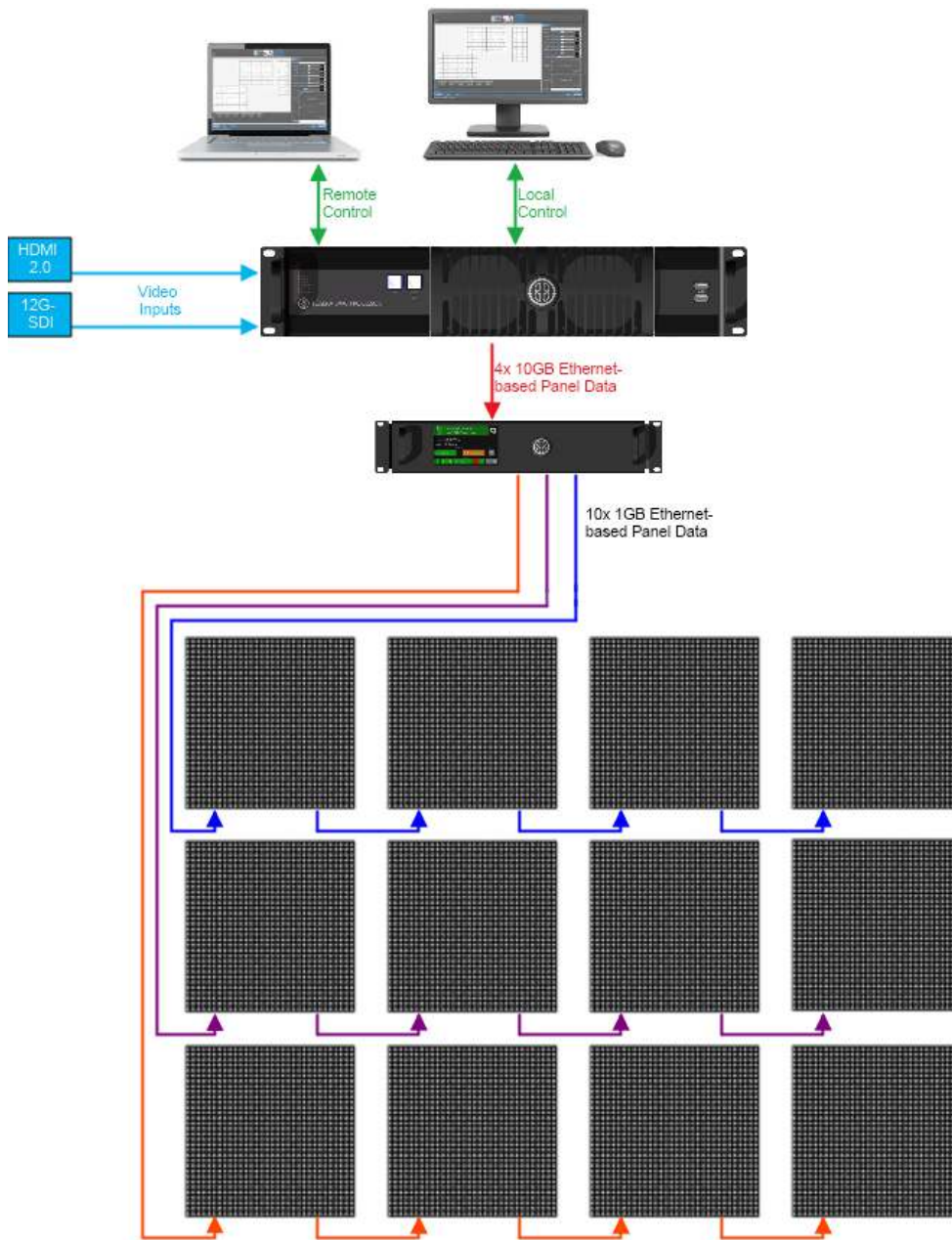

Figure 2-2. Typical system set-up for SX40 processor

TESSERA SX40 LED PROCESSOR

FRONT PANEL

TESSERA SX40 | FRONT



Feature	Description
Front Panel Status LEDs	
Blackout button	Sends the output of the processor to black
Freeze button	Freezes the output of the processor
Reset button	Press to reset the processor, press and hold to restore to factory settings. <i>Warning, this will delete all project files and fixture packs not included with the base firmware.</i>
2 x USB 2.0 type A ports	To connect USB memory storage devices and peripherals e.g. keyboard and mouse

FRONT PANEL STATUS LEDs

LED Name	Indication
Active	On: Processor in operation
	Blinking: Processor booting up
Ethernet	The processor is detecting a network connection
Video In	The processor is connected to a valid video input source
Tessera Out	The processor is connected to fixtures
Reference In	The processor has a valid source of genlock connected to the reference input connector
Overtemp	Off: Processor is in normal operating temperatures
	Blinking: Processor overheating but operational
	On: Processor overheated and shutdown

REAR PANEL CONNECTIONS

TESSERA SX40 | REAR

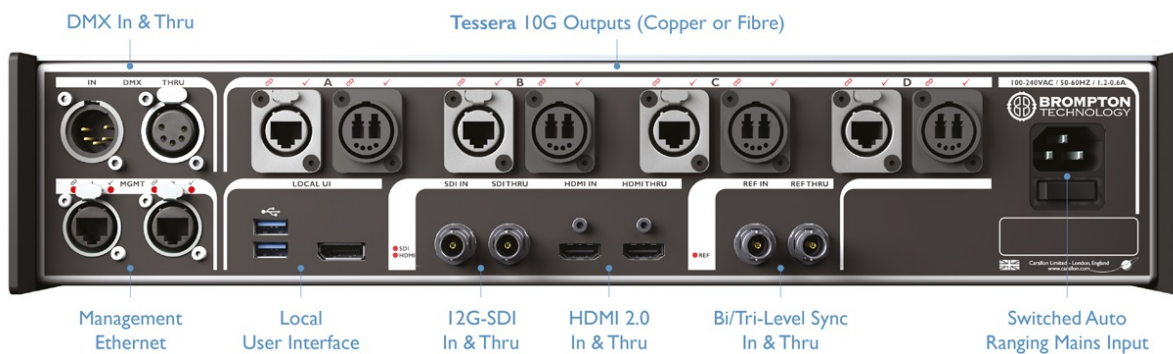

Feature	Description
Management Ethernet	Connect a PC or Mac running Tesseract Remote, Tesseract Control applications or an eDMX protocol directly to the local data Gigabit Ethernet port. The two ports work as a switch to daisy-chain units.
Local User Interface	Tesseract SX40 LED processor can be operated locally with a monitor connected via DisplayPort. Peripherals such as mouse and keyboard can be connected to the USB ports on either the front or rear panel.
HDMI Input	A HDMI 2.0 input with support for digital 4k progressive signal up to 4096x2160 @ 60Hz (600MHz pixel clock). See " Canvas Resolutions " on page 42 for more information.
Reference Input	Used for analog bi-level or tri-level sync.
12G-SDI Input	A 12G-SDI input is available. The SDI inputs supports HD-SDI, 3G-SDI level A or level B, 6G-SDI and 12G-SDI, 2SI format; SQ not supported. 12G-SDI accepts a progressive signal of up to 4096 x 2160 resolution at 23.98Hz to 60Hz framerate with 10 bits per channel colour depth.
Loop Thru Ports	All video inputs and syncs have re-clocked loop thru ports.
10 Gigabit Ethernet Outputs	The Tesseract SX40 LED processor has four 10 Gigabit outputs which can be used by plugging an XD unit to distribute the signal. Fixtures should be connected to the EtherCON connectors in the XD unit with Gigabit Ethernet cable (Cat-5e or above). See " System Configuration " on page 21 for more information.
DMX512-A Input and Thru	For DMX real-time control.
On/Off Switch	The processor can be shut down from the local interface or remote computer. No harm will result from turning the processor off at the switch.
IEC Mains Input	The input is auto ranging from 100-250v/47-63Hz.

TESSERA XD DISTRIBUTION UNIT

FRONT PANEL

TESSERA XD | FRONT



Front Panel Touchscreen

A front touchscreen displays some information for confirmation during setup and troubleshooting. This includes:

- All Ethernet port link states
- Processor connection state
- The name of the current project open on the Tessler SX40
- XD name for easy identification in large projects

The screen orientation and brightness is configurable, and the screen and per-port LEDs may be disabled for operating in dark environments.

Firmware is reloadable from the Tessler SX40, just as with other Tessler fixtures.

REAR PANEL CONNECTIONS

TESSERA XD | REAR

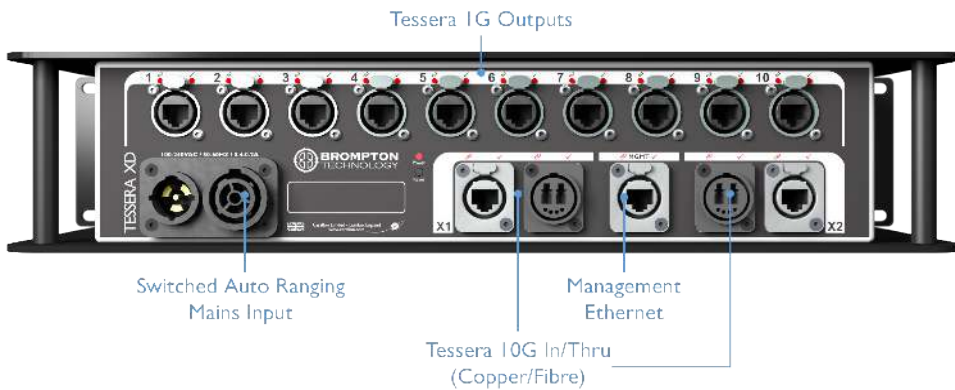

Feature	Description
Two 10G Tessera Protocol copper inputs for connection from Tessera SX40	<p>Supports Neutrik EtherCON Cat 6A / etherCON (CAT5e) connectors</p> <p>Compatible with standard RJ45 connectors</p> <p>Requires Cat6A cable (up to 60m) or Cat5e cable (up to 30m)</p> <p>One of the 10G ports can be used as thru connection for daisy-chaining of additional XDs</p>
Two 10G Tessera Protocol fibre inputs for connection from Tessera SX40 (Single mode ONLY)	<p>Supports Neutrik opticalCON DUO / DUO ARMORED / DUO X-TREME / DUO LITE connectors</p> <p>Compatible with standard LC-Duplex connectors</p> <p>Requires 1310nm, 9/125um single-mode fibre (up to 2KM) with PC or UPC connectors</p> <p>One of the 10G ports can be used as thru connection for daisy-chaining of additional XDs</p> <p>Auto-switching between fibre and copper</p> <p>Thru port auto-switches independently from input</p>
Up to five XDs may be daisy-chained	<p>Position 1G output ports in multiple locations for cabling convenience</p> <p>Bandwidth of each 1G port is shared between all daisy-chained XDs</p> <p>Extend 10G cable lengths using an XD as a signal repeater</p> <p>Convert between 10G fibre and 10G copper (or vice versa) using an XD as a media converter</p>
Ten 1G Tessera Protocol outputs for connection to fixtures	<p>Neutrik etherCON connectors, compatible with standard RJ45</p> <p>Each 1G output supports a nominal 525K pixels at 8bpc, 60Hz</p> <p>Pixel capacity per 1G port scales according to selected bit depth and framerate</p>

TESSERA M2 LED PROCESSOR

FRONT PANEL

TESSERA M2 | FRONT



Feature	Description
Front panel status LEDs	
Reset button	Press to reset the processor, press and hold to restore to factory settings. <i>Warning, this will delete all project files and fixture packs not included with the base firmware</i>
2 x USB 2.0 type A ports	To connect USB memory storage devices and peripherals e.g. keyboard and mouse

FRONT PANEL STATUS LEDS

LED Name	Indication
Active	On: Processor in operation
	Blinking: Processor booting up
Ethernet	The processor is detecting a network connection
DMX In	A DMX Signal is being received by the processor
Video In	The processor is connected to a valid video input source
Reference In	The processor has a valid source of genlock connected to the reference input connector
Tessera Out	The processor is connected to fixtures
Black/Freeze	Either the blackout or freeze button has been enabled
Overtemp	Off: Processor in normal operating temperatures
	Blinking: Processor overheating but operational
	On: Processor overheated and shutdown

REAR PANEL CONNECTIONS

TESSERA M2 | REAR



Feature	Description
Management Ethernet	Connect a PC or Mac running the Tessler Remote, Tessler Control application or an eDMX protocol directly to the local data Gigabit Ethernet port. The two ports work as a switch to daisy-chain units.
Local User Interface	The M2 processor can be operated locally with a monitor connected via DisplayPort. Peripherals such as mouse and keyboard can be connected to the USB ports on either the front or rear panel.
DVI Input	A DVI input of up to 1920x1080 @ 60Hz (148.5MHz pixel clock) is supported. This is a DVI-I input which supports DVI-D, VGA/ RGBHV and Component Analogue (YPbPr) with a suitable adapter. See " Canvas Resolutions " on page 42 for more info.
Reference Input	Used for analog bi-level or tri-level sync.
3G-SDI Input	Two 3G-SDI inputs are available. Both inputs can be used concurrently as an independent input. The SDI inputs support 3G-SDI level A or level B. Both inputs can be used together to support Dual Link HD-SDI. 3G-SDI accepts progressive and interlaced signal of up to 1920x1080 resolution at 23.98Hz to 60Hz framerate with 10 bits per channel colour depth.
Loop Thru Ports	All video inputs and syncs have re-clocked loop thru ports.
Gigabit Ethernet Outputs	The M2 processor has four 1 Gigabit Ethernet outputs which are provided on EtherCON connectors. Fixtures must be connected using Gigabit Ethernet cable (Cat-5e or above). See " System Configuration " on page 21 for more info.
DMX 512-A Input	For DMX real-time control.
On/Off Switch	The processor can be shut down from the local interface or remote computer. No harm will result from turning the processor off at the switch.
IEC Mains Input	The input is auto ranging from 100-250v/47-63Hz

TESSERA S4 LED PROCESSOR

FRONT PANEL

TESSERA S4 | FRONT



Feature	Description
Front panel status LEDs	
Black button	Sends the output of the processor to black
Freeze button	Freezes the output of the processor
Reset button	Press to reset the processor, press and hold to restore to factory settings. <i>Warning, this will delete all project files and fixture packs not included with the base firmware</i>
2 x USB 2.0 type A ports	To connect USB memory storage devices and peripherals e.g. keyboard and mouse

FRONT PANEL STATUS LEDS

LED Name	Indication
Active	On: Processor in operation Blinking: Processor booting up
Ethernet	The processor is detecting a network connection
Video In	The processor is connected to a valid video input source
Tessera Out	The processor is connected to fixtures
Overtemp	Off: Processor is in normal operating temperatures Blinking: Processor is overheating but operational On: Processor overheated and shutdown

REAR PANEL CONNECTIONS

TESSERA S4 | REAR

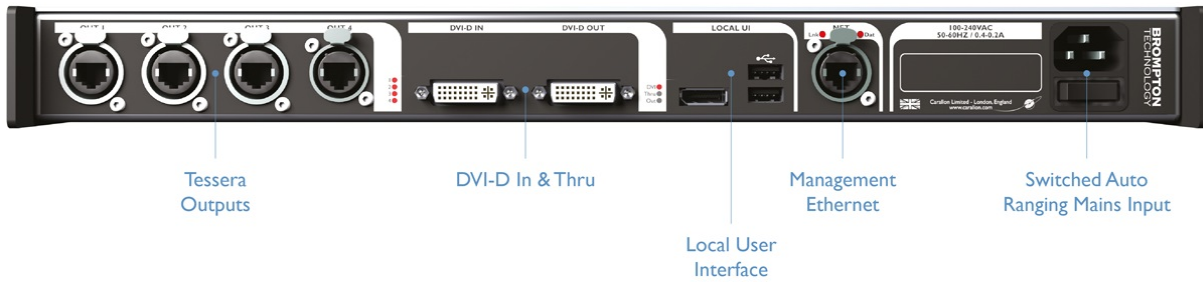

Feature	Description
Management Ethernet	Connect a PC or Mac running the Tessler Remote, Tessler Control application or an eDMX protocol directly to the local data Gigabit Ethernet port.
Local User Interface	The S4 processor can be operated locally with a monitor connected via DisplayPort. Peripherals such as mouse and keyboard can be connected to the USB ports on either the front or rear panel.
DVI Input	A DVI input of up to 1920x1080 @ 60Hz (148.5MHz pixel clock) is supported. This is a DVI-D input, with a re-clocked DVI-D thru. See " Canvas Resolutions " on page 42 for more info.
Gigabit Ethernet Outputs	The S4 processor has four 1 Gigabit Ethernet outputs which are provided on EtherCON connectors. Fixtures must be connected using Gigabit Ethernet cable (Cat-5e or above). See " System Configuration " on page 21 for more info
On/Off Switch	The processor can be shut down from the local interface or remote computer. No harm will result from turning the processor off at the switch.
IEC Mains Input	The input is auto ranging from 100-250v/47-63Hz

TESSERA T1 LED PROCESSOR

FRONT PANEL

TESSERA T1 | FRONT



Feature	Description
Front panel status LEDs	
Reset button	Press to reset the processor, press and hold to restore to factory settings. <i>Warning, this will delete all project files and fixture packs not included with the base firmware</i>
2 x USB 2.0 type A ports	To connect USB memory storage devices and peripherals e.g. keyboard and mouse

FRONT PANEL STATUS LEDS

LED Name	Indication
Active	On: Processor in operation Blinking: Processor booting up
Ethernet	The processor is detecting a network connection
DMX In	A DMX signal is being received by the processor
Video In	The processor is connected to a valid video input source
Tessera Out	The processor is connected to fixtures
Black/Freeze	Either the blackout or freeze button has been enabled
Overtemp	Off: Processor is in normal operating temperatures Blinking: Processor is overheating but operational On: Processor overheated and shutdown

REAR PANEL CONNECTIONS

TESSERA T1 | REAR

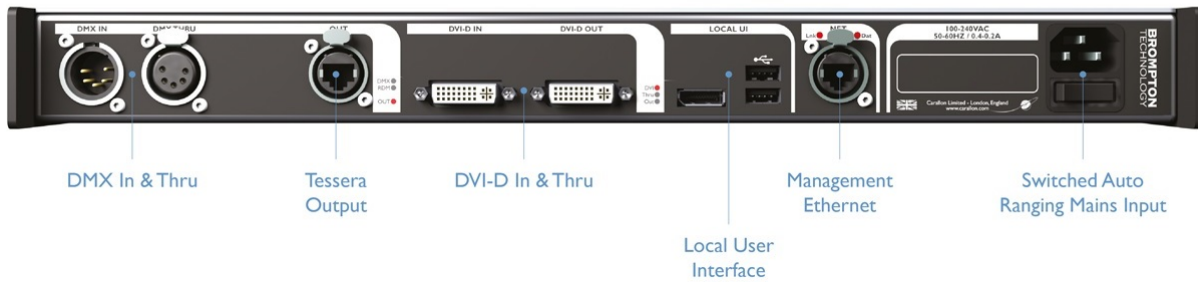

Feature	Description
Management Ethernet	Connect a PC or Mac running the Tessler Remote, Tessler Control application or an eDMX protocol directly to the local data Gigabit Ethernet port.
Local User Interface	The T1 processor can be operated locally with a monitor connected via DisplayPort. Peripherals such as mouse and keyboard can be connected to the USB ports on either the front or rear panel.
DVI Input	A DVI input of up to 1920x1080 @ 60Hz (148.5MHz pixel clock) is supported. This is a DVI-D input, with a re-clocked DVI-D thru. See " Canvas Resolutions " on page 42 for more info.
DMX 512-A Input	For DMX real-time control.
Gigabit Ethernet Outputs	The T1 processor has one 1 Gigabit Ethernet output which are provided on EtherCON connectors. Fixtures must be connected using Gigabit Ethernet cable (Cat-5e or above). See " System Configuration " on page 21 for more info
On/Off Switch	The processor can be shut down from the local interface or remote computer. No harm will result from turning the processor off at the switch.
IEC Mains Input	The input is auto ranging from 100-250v/47-63Hz

CHAPTER 3 - QUICKSTART

Follow this chapter to get a basic system up and running. This guide covers starting a new project with fixtures connected. To set up a project offline and connect fixtures at a later stage, see [“Tessera Management Software”](#) on page 30 for more info.

TESSERA PROCESSOR SETUP

1.
 - a. **M2, T1 and S4 users:** Connect fixtures to the Tessera output ports on the rear panel of the processor using Gigabit Ethernet cable (Cat 5e or above) and network switches.
 - b. **SX40 users:** Connect the XD unit to the processor using either copper or fibre optic cables. Fixtures are required to be connected to the XD unit.

Note - Tessera SX40 processor does not feature support sub-fixtures. Tessera firmware version 2.3 will introduce support for sub-fixtures.

2. Connect the video input source(s) to the DVI, HDMI and/or SDI input ports.
3. Connect a monitor to the Local UI using the DisplayPort connector and connect a mouse and keyboard. Alternatively, access the processor's user interface through a Mac or Windows PC running the Tessera Remote application.
4. Connect the IEC mains input and switch the processor on. When the processor has powered up, the monitor displays the start screen. By default, the processor is configured to automatically load the previous project after a set amount of time if the user does not intervene.

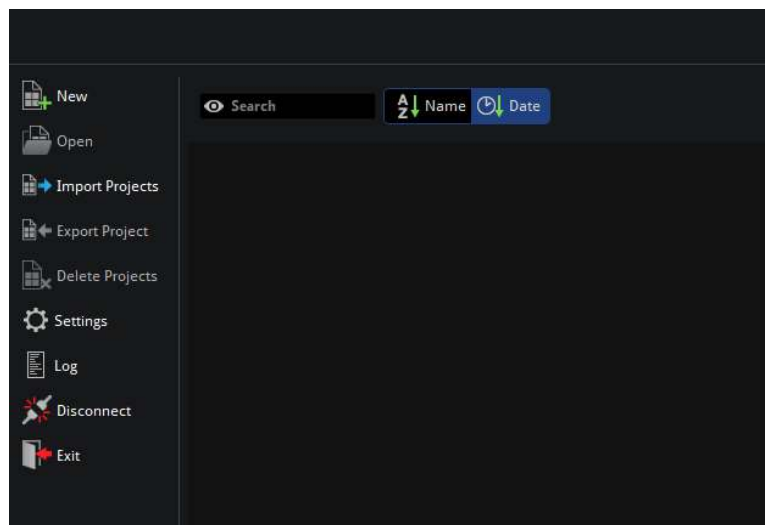

Figure 3-1. The Start Screen

TESSERA PROJECT SETUP

1. From the Start Screen, select New to launch the Project Wizard.

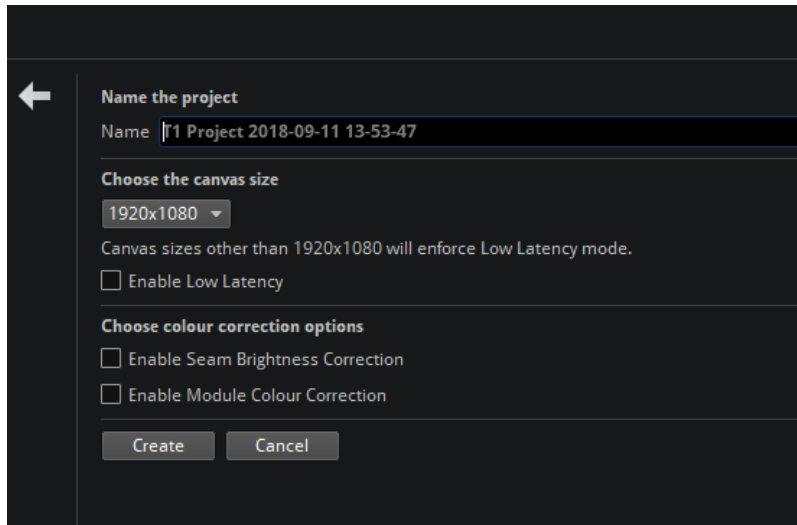

Figure 3-2. The New Project Wizard

2. The project name can be manually entered, if no entry is made, a default project name containing the processor's model with a date and time stamp is assigned.
3. Select a canvas size from the drop-down menu. When selecting a resolution other than the native 1920x1080, Tessera M2 and T1 processors enforce Low Latency Mode.
4. Click Create to be taken to the Main Project Screen.
5. The project is saved to the processor's internal storage. When using Tessera Remote, project files are also saved to the connected computer.

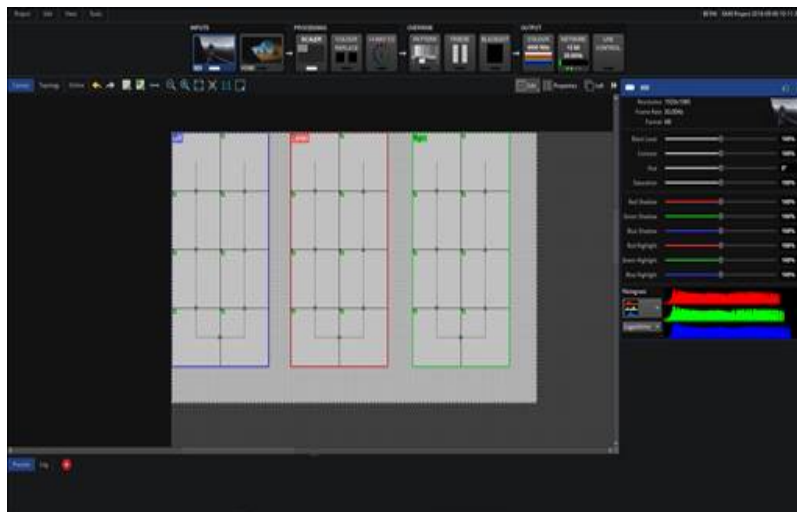

Figure 3-3. Main Project Screen

CONNECTING FIXTURES

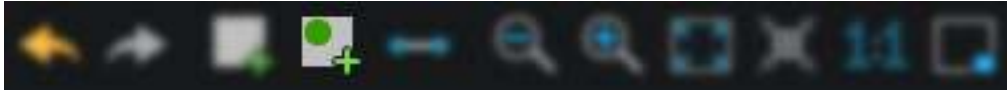

Figure 3-4. Add Fixtures from Network button

1. Ensure that all fixtures are connected to the processor with the desired topology, taking into consideration the output port's capacity limit.
2. Click the Add Fixtures From Network button. The canvas toolbar is replaced with a row of currently connected fixtures. When using Add Fixtures From Network, strings of fixtures are highlighted with colours corresponding to the ones shown in the UI. Each string is assigned a unique numeric code which appears on the first fixture of the string during association.

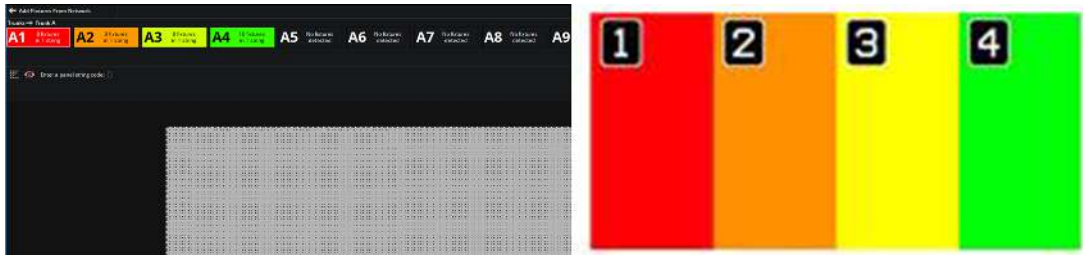

Figure 3-5. The Add Fixtures From Network toolbar, the right-side shows connected fixtures whilst in Add Fixtures From Network menu.

3. Entering this code on the processor (using number keys or numpad) selects the corresponding string for association. The string is then ready to be drawn in the canvas using the cursor.



Figure 3-6. Associating Fixtures

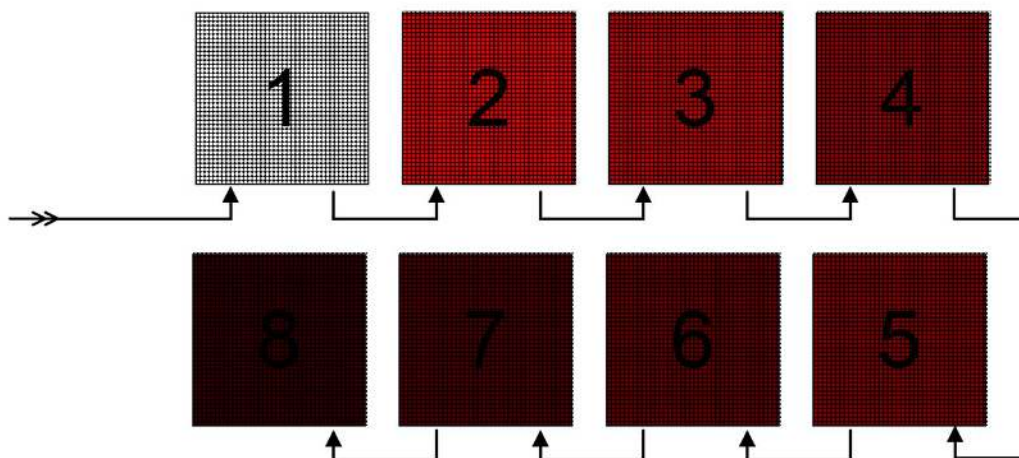
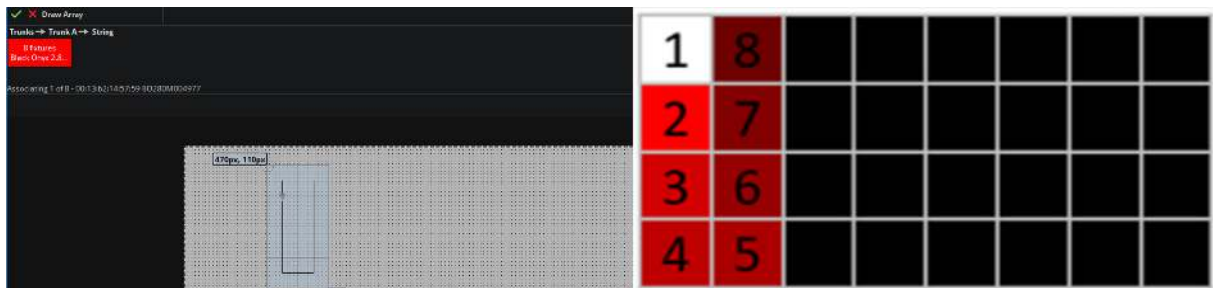
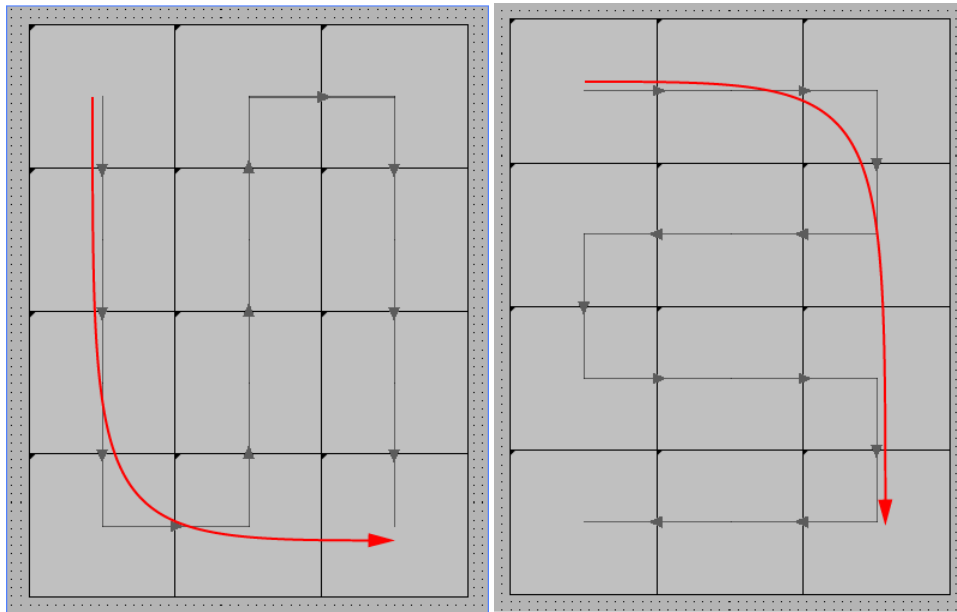

Figure 3-7. A highlighted Recoloured string

4. The first fixture in the string is highlighted white, while other fixtures display varying shades of the same colour to denote the order of the fixtures in the string - from brightest to darkest.
5. Click on the canvas to add fixtures one by one. The currently selected fixture is highlighted in white on the LED panel.



- Clicking and dragging will draw an array of fixtures. The topology is defined by the direction taken when drawing the array.



- Repeat the process for all strings, then press Enter or click the Back arrow to return to the Main Project Screen.
- Fixtures on the canvas display a green circle to indicate online status. If the input source is connected, the fixtures will output video.

CHAPTER 4 - SYSTEM CONFIGURATION

CONNECTING FIXTURES

Tessera processors drive Tessera compatible devices. Tessera compatible fixtures are fitted with an Tessera receiver card inside, either in each tile or cabinet, or in a root node connected to strings of sub-fixtures.

All Tessera compatible fixtures have two gigabit Ethernet ports: one to connect to the processor and one to connect to the next device in the chain. These ports are interchangeable for convenience.

The processor communicates with fixtures on the network using the Tessera protocol. The system topology requires fixtures to be connected to the HD processor or XD distribution unit. Once connected, a group of fixtures in a daisy-chain becomes a string.

Note - Tessera Protocol only supports gigabit ethernet compliant equipment and does not function with 100BASE-T (Fast Ethernet) or 10BASE-T.

The 10 gigabit connection between the XD and SX40 processor must be direct, using fibre optic or Cat6a or above cabling.

See "[Cable Requirements For Tessera SX40 and XD](#)" on page [177](#).

CONNECTION GUIDELINES

1 GIGABIT DATA CONNECTION

Tessera devices need to be connected to the HD processor or XD unit directly or via a gigabit ethernet network switch, using cables that conform to Cat 5e or above and include RJ45 and EtherCON terminations.

The maximum supported individual cable length is 100 meters. The Tessera protocol can be transmitted over standard gigabit ethernet compliant fibre optic hardware for single runs exceeding this distance.

The suggested maximum number of nodes between the processor and the furthest fixture in any system is five switches and 50 fixtures (XD units and fibre optic transceivers count as switches). By using switches, up to 500 fixtures can be run from a Tessera processor output port (assuming this does not exceed the pixel limit of the output).

Note - The Tessera Protocol does not support connection over Wi-Fi due to the bandwidth required to alter content and fixtures.

10 GIGABIT DATA CONNECTION

The connection between the SX40 processor and the XD distribution units needs to be direct by using single-mode fibre-optic cables with PC or UPC DUO connectors for a length of up to 2Km or Cat6a or above cabling with RJ45 or EtherCON terminations to reach a maximum distance of 60m.

REDUNDANCY CONFIGURATION

CLOSED LOOP REDUNDANCY

Closed loop redundancy is supported on Tessera SX40, M2 and S4 LED processors where two outputs can be configured to operate as a redundant pair. Closed loop redundancy is not supported on Tessera T1 LED processors as they only feature a single output.

For the Tessera M2 and S4 processors with closed loop redundancy, a cabling loop is created from the primary port, through a string of fixtures, and then back to the processor. One output acts as the primary port, while the second output acts as the backup. In the case of signal loss or errors with the primary feed, the backup port takes control and re-allocates fixtures to use the backup feed. The change is done within one frame, ensuring live content continues to display in the event of failures occurring anywhere in the loop.

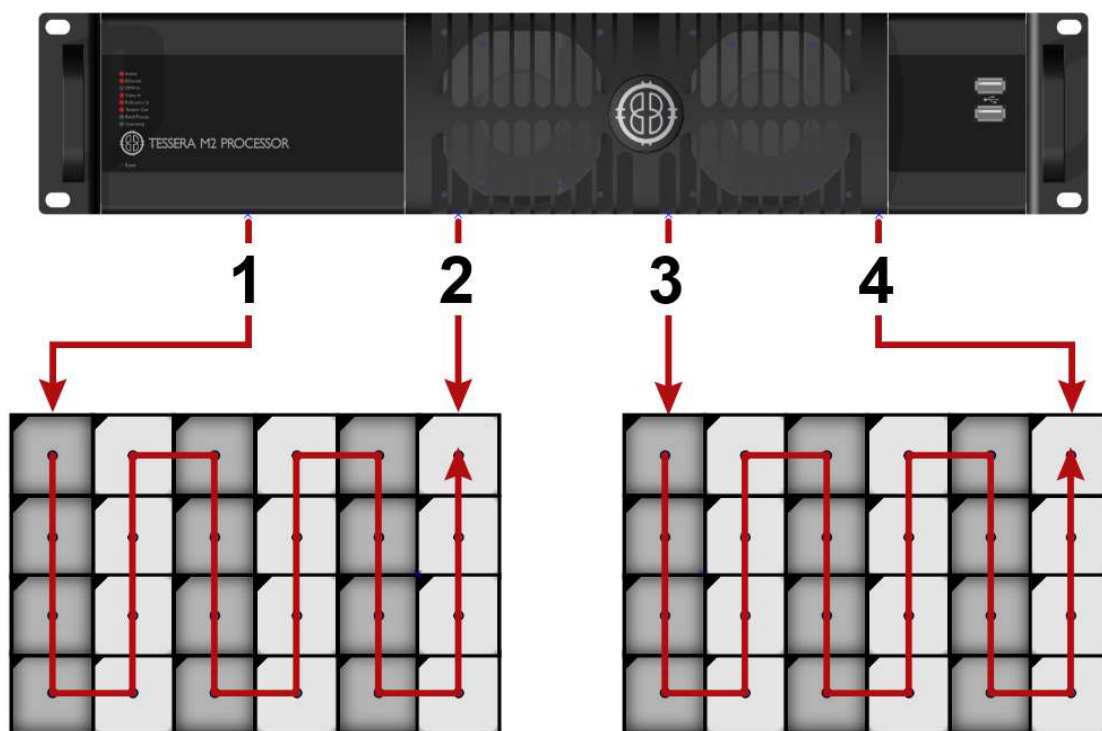

Figure 4-1. Tessera processor setup with redundancy

The load capacity for each redundant pair is the same as for a single non-redundant port. Redundancy is only available from port 1 to port 2, and from port 3 to port 4.

Once the system has been cabled correctly, click on the Network pipeline tile. Under redundancy the user can enable redundancy for connected ports. The processor is also able to detect faults with cabling and reports Loop OK or Errors Detected for connected ports.

For Tessera SX40 processor, loop redundancy is created between two trunks, from A to B and C to D. For more information see on page [24](#)

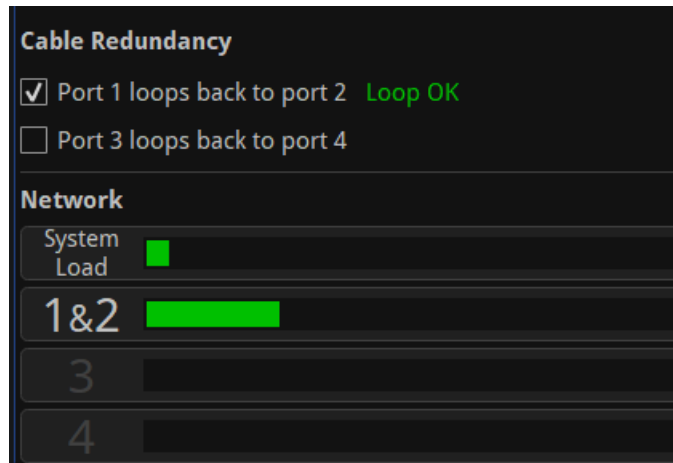

Figure 4-2. Redundancy options on the Network tab for Tessler processors

The Network tab includes the loop status indicator and a load bar for a redundant output pair on ports 1 and 2. Ports 3 and 4 continue to operate independently without redundancy.

Note - The system load will double when redundancy is enabled, this is because twice the amount of bandwidth is needed to ensure primary and backup signals are maintained.

In the Tessler SX40, 10Gb trunk pairs can be (independently) configured for redundant operation (A+B, C+D) however symmetry must be maintained.

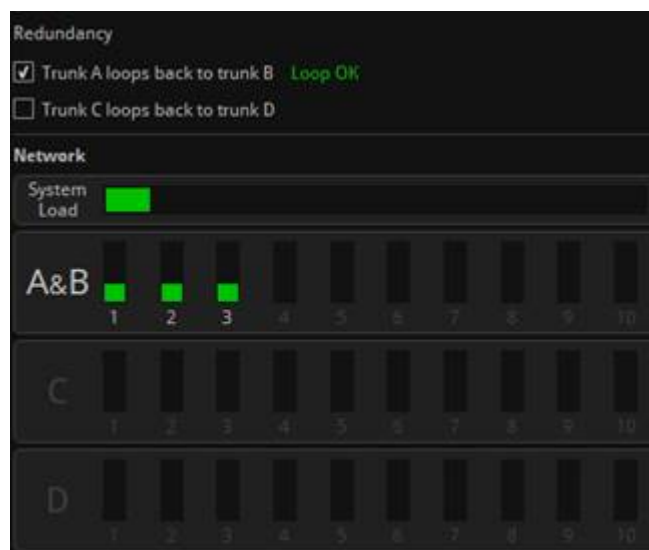

Figure 4-3. Tessler interface with redundancy configured on trunks A and B

Fixture chains must be connected to the same port of the same XD on both primary and backup trunks. XDs are mirrored on the backup trunk.

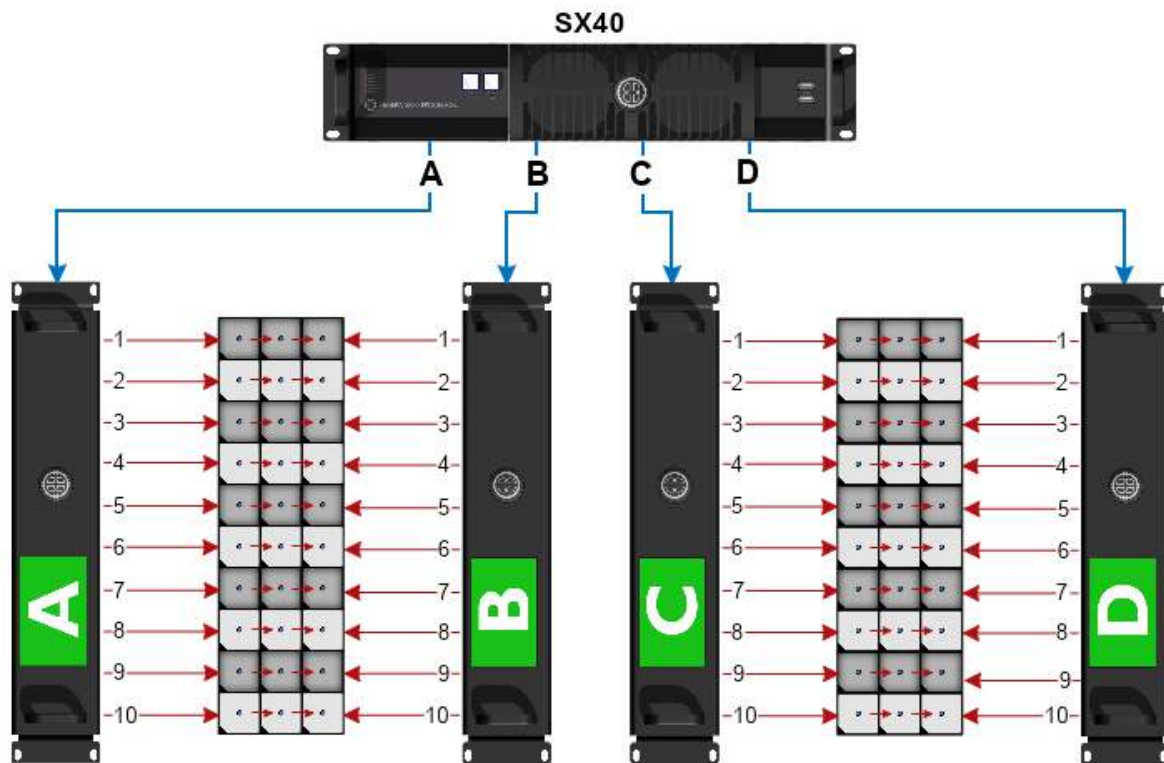

Figure 4-4. Tesseract SX40 configured with redundancy for trunks A and B and C and D

When operating in redundancy mode:

- Fixtures can be cabled in a single chain of up to 50 fixtures, with each end of the chain connected back to the processor (or Tesseract XD when using a Tesseract SX40). Ethernet switches must not be used to split the signal. Other Ethernet hardware (such as fibre extenders) are supported.
- Closed loop redundancy should be enabled on the processor.
- The output capacity limits that apply to a single port also apply to the pair of ports. This effectively halves the overall processor capacity, as each output signal is being 'doubled up'. This also applies to Tesseract SX40, therefore twice the amount of XD units would be required.
- The total network load for the two ports combine into a single bar indicating the load for that pair.
- Switching in and out of redundancy mode will momentarily black-out the video signal for all connected fixtures on all ports. Redundancy mode should be configured in advance.
- The active feed (primary or backup) used by each fixture can be viewed in the Online tab.
- If both the primary and backup signals are operational, each fixture can alternate between either signal. If a fixture receives a video error or complete signal loss from one port, it will switch to the backup port for the next frame.
- For Tesseract M2/T1/S4 LED processors, each loop must be cabled between the two adjacent ports on the same processor. (I.e. Port 1 to Port 2, and Port 3 to Port 4.)
- For Tesseract SX40, the loop is created using the same trunk port number in two adjacent XD units (i.e. Trunk A to Trunk B, and Trunk C to Trunk D)

PROCESSOR REDUNDANCY

Only available for the Tessera SX40, processor redundancy is designed as a backup system should the primary processor fail to send a signal to the fixtures. If the primary processor stops outputting video signal, the backup processor will detect the fault and re-associate fixtures. Fixtures will lose video signal momentarily and will automatically resume within 1-2 seconds.

Different types of failure can trigger failover including; power issues, closing project, loss of input signal, fixture data cable disconnection, processor failure, or if failover is activated by the user.

To set up processor redundancy:

1. Connect the primary and backup processor to the X1 and X2 ports of the XD units.
2. Enable failover in the failover tab of both processors.
3. Select the role of each processor, either primary or backup.
4. Different criteria can be set for auto-failover behaviour:
 - If the primary processor fails for (x) seconds
The backup processor takes control if the primary processor's Tessera output is missing for (x) seconds
 - If the primary video source is lost for (x) seconds
The backup processor takes control if the primary processor's video feed is missing for (x) seconds
 - If both front panel buttons are pressed together
Failover can be triggered manually by pushing both front panel buttons at the same time
 - Always prefer primary if available , auto-failover back to the primary processor whenever it becomes available

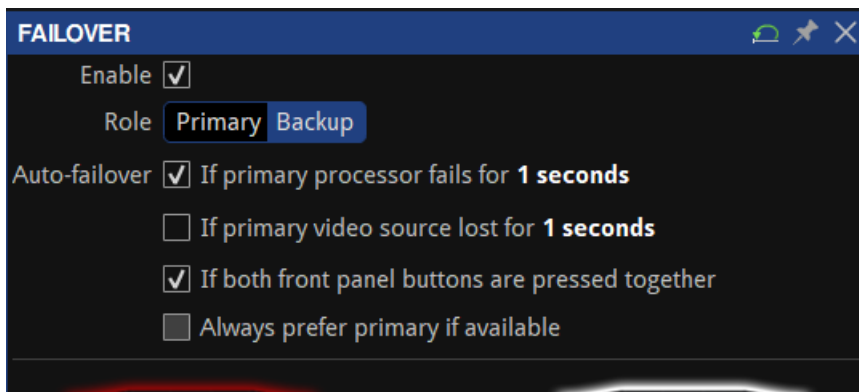

5. Video input cabling
 - Both processors may be fed from the same video source if required. HDMI/SDI thru can be used but isn't recommended; an upstream splitter is preferable.
 - Each processor may be fed from a completely independent video source if required. These may be different formats (HDMI/SDI), resolutions, framerates, etc. - there's no requirement for any aspect of the sources to match.
 - External reference signals (if in use) may similarly be shared or independent between the two processors.
6. Both processors must be set up independently of each other. Set the project in both processors to display the desired image. Settings such as fixture position in the canvas, video input and colour correction can be modified independently, so precautions should be taken to avoid differences between processors. Using the same settings with the same video source is advised. It is a good practice to use the same show-file in both processors, making sure that one is set as primary and the other one as backup.

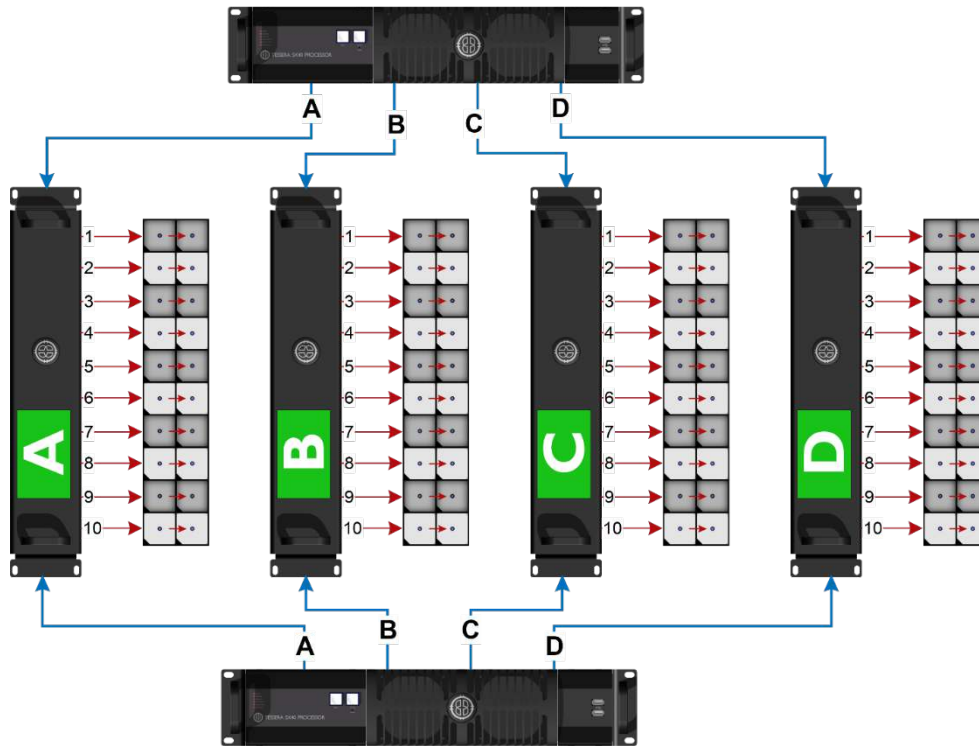

Figure 4-5. Processor redundancy

Processor redundancy is compatible with closed loop redundancy, offering different setup possibilities based on the system requirements.

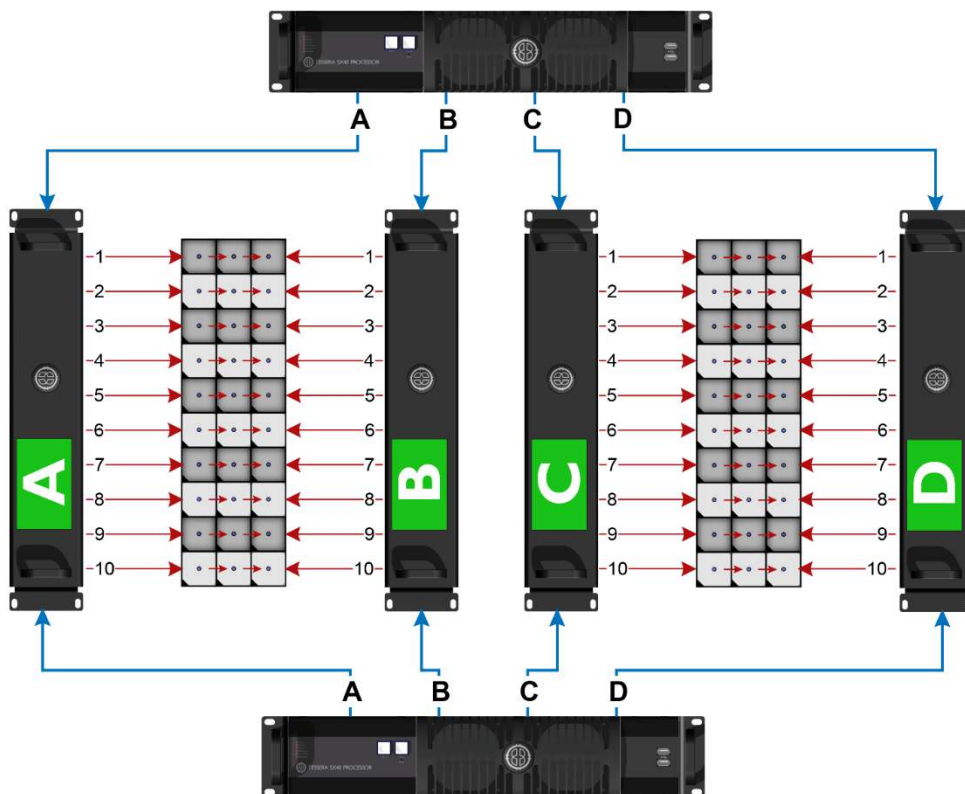

Figure 4-6. Tessera SX40 LED processor and loop redundancy

OUTPUT CAPACITY

The Tessera output port capacity depends primarily on the network bit depth and frame rate. The nominal pixel capacity per port is outlined in the table below:

Refresh/Bit Depth	8 bit	10 bit	12 bit
24hz	1,312,500	1,050,000	875,000
25hz	1,260,000	1,008,000	840,000
30hz	1,050,000	840,000	700,000
50hz	630,000	504,000	420,000
60hz	525,000	420,000	350,000

OTHER FACTORS AFFECTING OUTPUT CAPACITY

Fixture Rotation

Rotating fixtures on-axis (i.e. by 0°, 90°, 180° or 270°) has no effect on the output capacity.

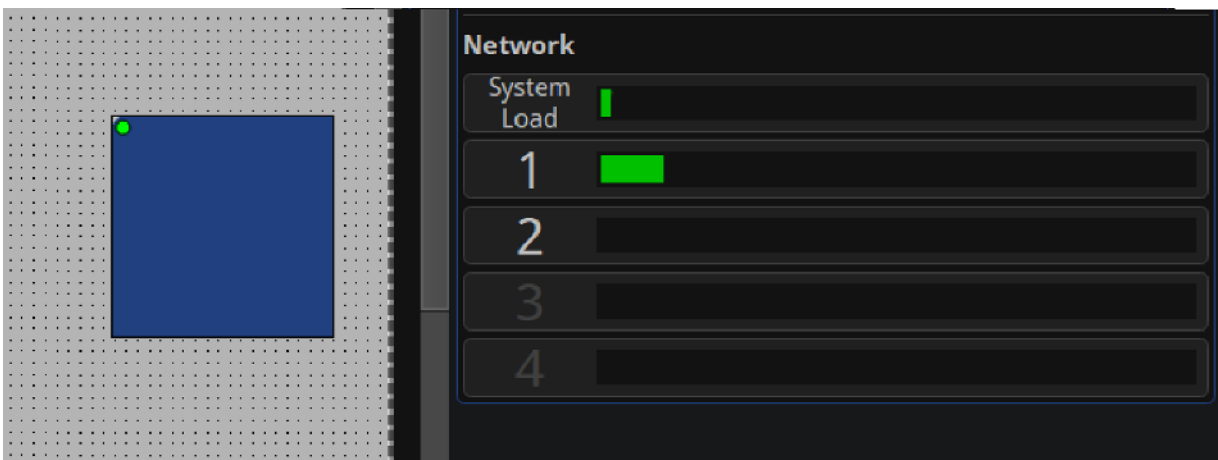

However, each fixture rotated off-axis is counted twice towards the output capacity.

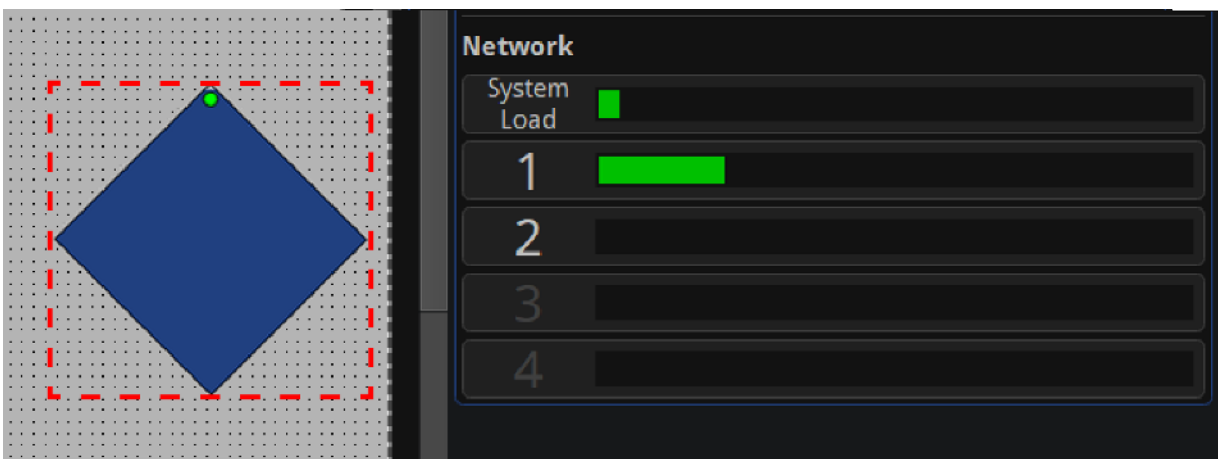

Mapping Mode For Projects With Multiple Fixtures

The M2 and T1 processors can use different mapping modes to fit the project's necessities. The SX40 and S4 always work with 1:1 mapping.

1:1 mapping doesn't affect the output capacity. This mode sends the pixels of the input to the fixtures without taking into consideration the fixture size, only the pixel number.

When using **interpolated mapping**, the content on fixtures with a coarser pixel pitch is scaled so that the content appears the same size across all fixtures. In this mode, all fixtures are assumed to have the same pixel pitch as the finest fixture, and the output capacity is calculated according to the physical dimensions of the fixture.

See "[Mapping Options](#)" on page [43](#) for more information.

Small Fixtures

Small fixtures - with either dimensions smaller than 16 pixels - have a high processing overhead. Therefore, the number of these fixtures supported may be fewer than that calculated from the nominal pixel capacity.

In terms of processing, the SX40 processor considers any connected fixture to be at least 64px in either dimension, so the total number of fixtures per port might be affected.

Estimating Fixture Capacity

When associating fixtures to a project, network load bars display the output capacity on each port. The UI updates in real time as settings such as network bit depth, genlock frame rate and fixture rotations are applied. See "[Network](#)" on page [142](#) for more information.

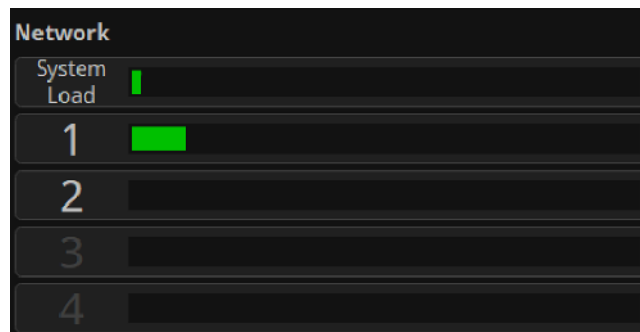

Figure 4-7. Network property editor showing system load and port load

To help with estimating the number of processors required for a project, we have created a simple web-based calculator tool which models all the factors outlined above. For further details, please contact support at: support@bromptontech.com

COMBINING PROCESSORS

The Tessera T1, S4, M2 and SX40 processors are designed to be used together in a configuration without issues. Different types of processors can be used to run different sections of the same wall.

When combining processors, to avoid tearing, it is important to synchronize them by matching their end to end delay and genlocking the sources.

The end to end delay of the different processors is:

T1	3 frames 2 frames in low latency mode
S4	2 frames (this processor is always in low latency mode)
M2	3 frames 2 frames in low latency mode
SX40	2 frames (this processor doesn't have low latency mode)

When working with different types of processors, the video latency requires re-adjusting per processor.

I.e. If using T1 and SX40 processors together, a frame of latency will have to be added to the SX40 processors, initially with 2 frames latency, to match the 3 frames of latency of the T1.

The processors need to be genlocked to the same source or to each other.

For more information about video delay and genlock, see "[Network](#)" on page [142](#).

Note - Please note that the difference in features between processors still apply. The SX40 does not have Low Latency mode but the scaler is disabled when using custom resolutions. See "[Low Latency Mode](#)" on page [43](#) for more details in the limitations when working in Low Latency mode.

CHAPTER 5 - TESSERA MANAGEMENT SOFTWARE

The Tessera Management Software is used to configure and control all aspects of Tessera Processors. The user interface can be accessed in two ways – locally with the use of a monitor, mouse and keyboard, or remotely using the Tessera Remote application.

The user interface is consistent across both access methods, with only subtle differences in functionality.

LOCAL USER INTERFACE

When using the local user interface on the processor itself, no external computer is required.

To view the user interface, connect a monitor to the local UI port on the rear of the processor. DisplayPort monitors are natively supported, other connection types require an adapter. Once connected, the native resolution of the monitor is automatically detected. To change the default resolution, navigate to Settings > Processor, select a resolution from the dropdown menu and click Commit. The minimum supported resolution for M2, T1 and S4 processors is 1024x768 and the maximum resolution is 1920x1080. Tessera SX40 processor supports UI resolutions of up to 3840x2160.

The user interface is controlled by connecting a mouse and keyboard to the processor's USB ports.

TESSERA REMOTE AND OFFLINE EDITOR

Tessera Remote is a Windows PC and Mac OS application that allows remote control of Tessera processors across a network. Additionally, the Remote application can be used as an 'offline editor' allowing the set up and editing of Tessera projects when not connected to a processor.

The main difference in functionality when working with the Tessera Remote app (not offline) is that the video on canvas edit modes are not available.

Tessera Remote is free to download from the Brompton Technology website:

<http://bromptontech.com/support>

Note - Tessera Remote software versions and the processor firmware versions must match. If the processor firmware version and Tessera Remote do not match, the firmware or remote software must be updated. The processor firmware can be updated from the remote app.

INSTALLATION FOR WINDOWS PC

1. Download Tessera Remote Windows software from <https://www.bromptontech.com/support>
2. Open the downloaded file to begin Setup Wizard. Hit Next to continue.

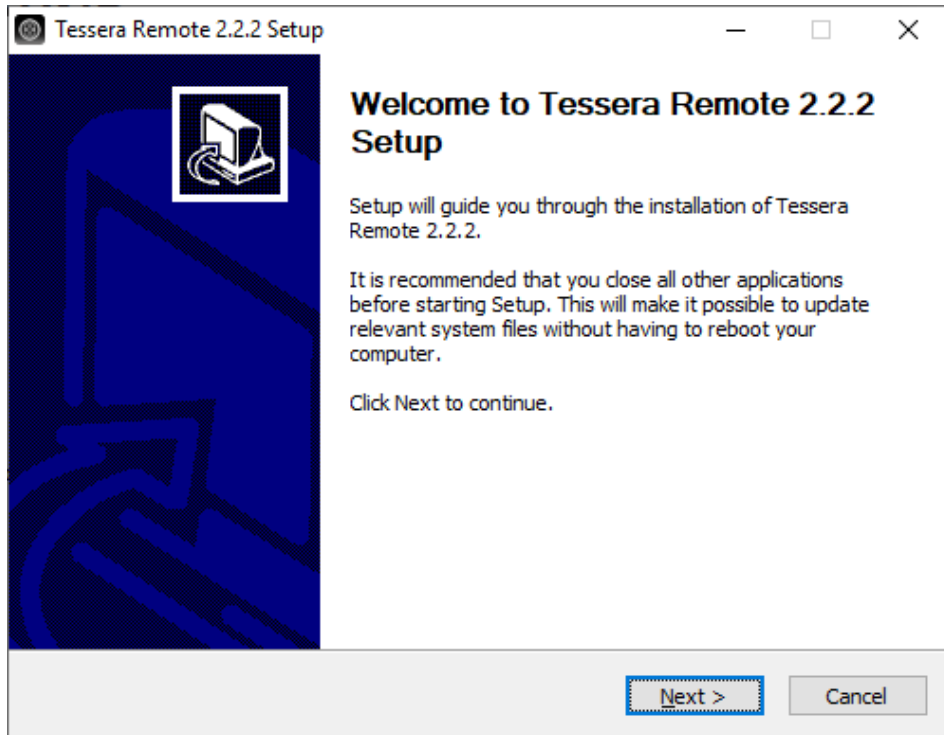

3. The setup wizard gives options to create shortcuts for your computer and whether to associate relevant files to the application.

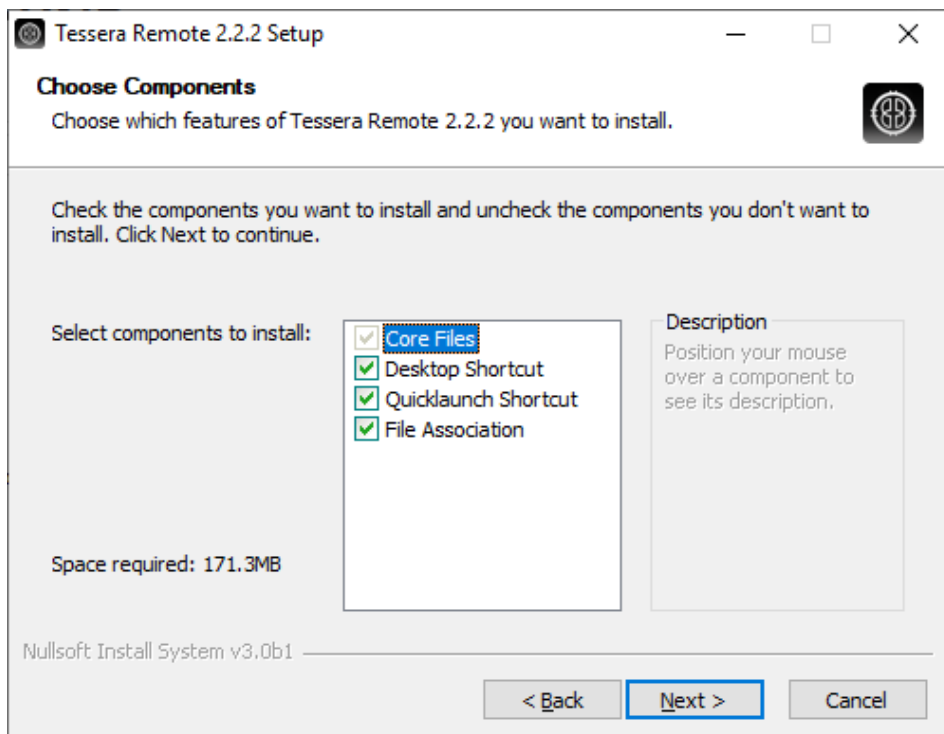

4. The setup wizard asks for an install location, once selected click Next to begin the installation.

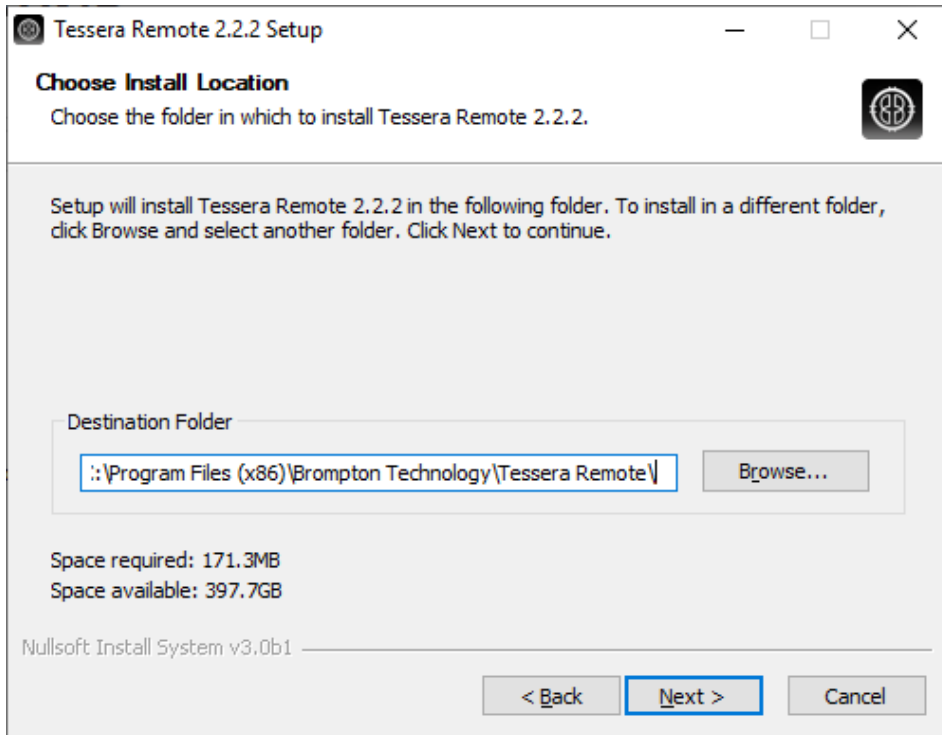

5. When the application has finished installing, a completion dialog box is displayed. Tick the 'Run Tessera Remote' box to launch the application after clicking Finish.

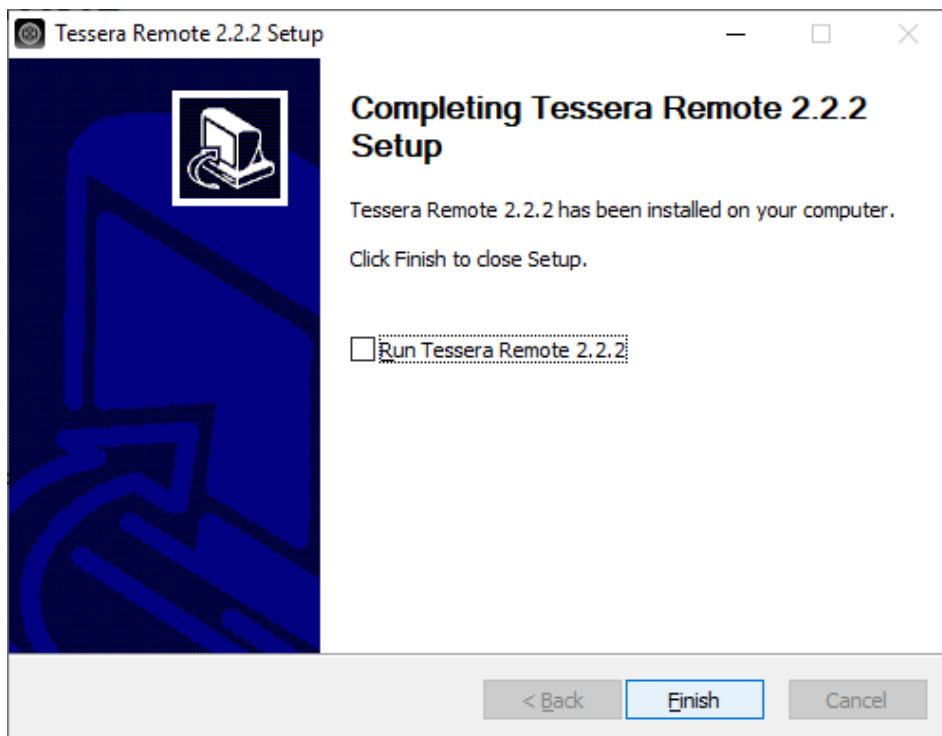

INSTALLATION FOR MAC OS X

1. Download Tesseract Remote Mac OSX installation file from Brompton's website <https://www.bromptontech.com/support>
2. Double click the .dmg file and drag the Tesseract Remote icon into the Applications Folder, or copy (⌘ + C) and Paste (⌘ + V) the Tesseract Remote icon into the Applications folder
3. Multiple software versions of Tesseract Remote Application can be installed on the same Mac computer. It can be helpful to store these in different folders within the Applications folder.

NETWORK SETTINGS FOR REMOTE MANAGEMENT

To connect a computer to a Tesseract processor, connect to the same network via Ethernet by setting the computer and processor to the same subnet mask and IP range. As the Tesseract processor's remote network port supports Auto MDI-X, this network can be as simple as using a Cat 5e cable connected to the Mac or Windows PC without the need for a switch.

The default IP settings for the processor are 192.168.0.50, with a subnet mask of 255.255.255.0.

For further details on setting IP addresses on Windows and Mac OS, see "[Setting IP Addresses](#)" on page [179](#).

Note - Due to the bandwidth limitations and reliability, wireless connections are not supported within the Tesseract systems.

CONNECTING TO A TESSERA PROCESSOR

Having physically connected a Mac or Windows PC to a Tessera processor via network, launch the Tessera Remote application. This will open a dialogue box to start Tessera Remote or the Offline Editor.

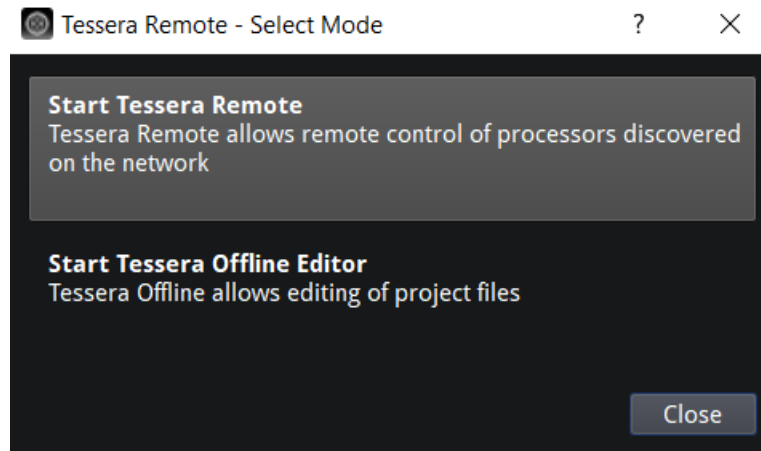

Figure 5-1. Start up menu for Tessera Remote

Click 'Start Tessera Remote' to start the application in Remote mode.

The application automatically detects connected processors on the network. Note the Tessera Remote software version. If it does not match the processor firmware version, reload processor firmware or install a matching Tessera Remote software version.

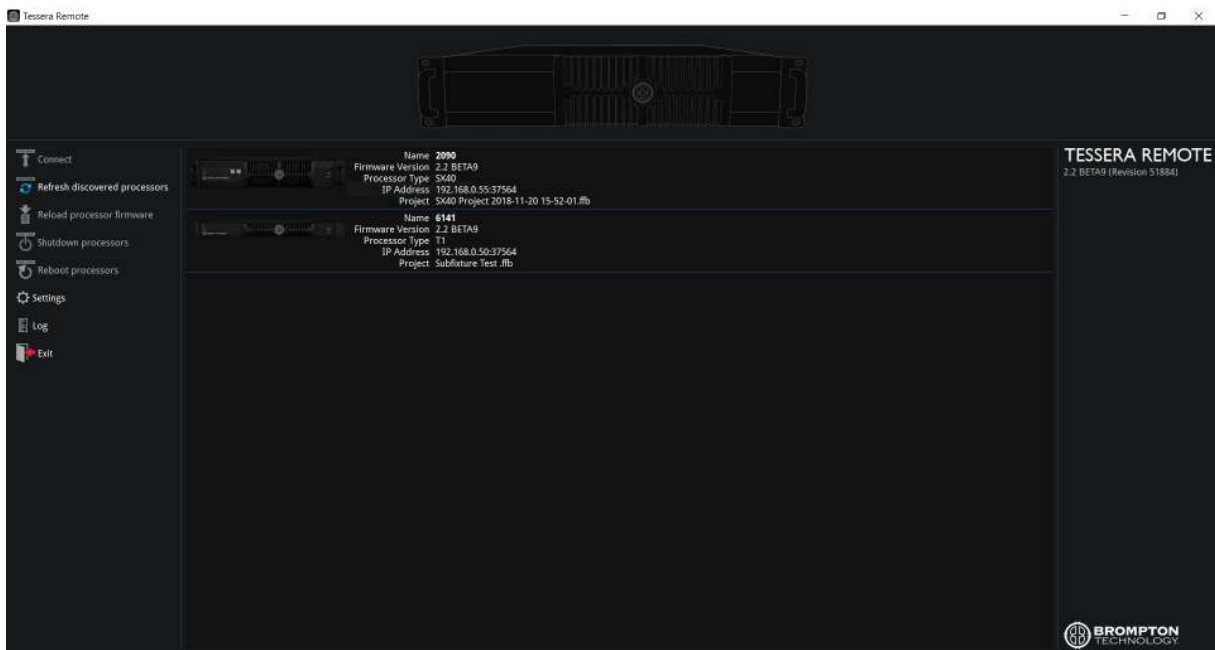

Figure 5-2. Tessera Remote main menu with processor select options.

When reloading processor firmware, the processor is temporarily inaccessible while firmware is written to the processor. Once this process is complete, the processor will reboot before becoming accessible again.

Discovered processors display the following details:

- User-defined name of the processor
- Firmware version
- Processor type

- IP address
- Project file that is currently in use

To connect to the processor, double click the processor, or select a processor and click Connect.

TESSERA REMOTE SETTINGS

The Tessera Remote offline mode Settings menu contains preferences which allow general customisation of the canvas, fixture packs management and selection settings within Tessera Remote. These settings are stored locally and not applied to the processor itself.

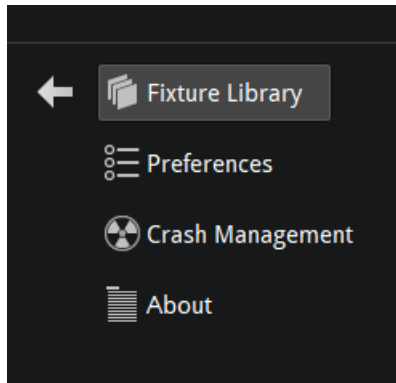

Figure 5-3. Tessera Remote settings menu

Once connected to the processor, the Remote application functions in a very similar way to the local user interface. For further detail about the Settings, see "[Processor Settings](#)" on page [155](#)

When Tessera Remote is connected to the processor, the Local Management app running on the processor cannot be used. Take control of the processor by clicking the Take Control icon.

DISCONNECTING FROM THE PROCESSOR

When closing the app or disconnecting from the processor, several options can be selected.

Closing the app:

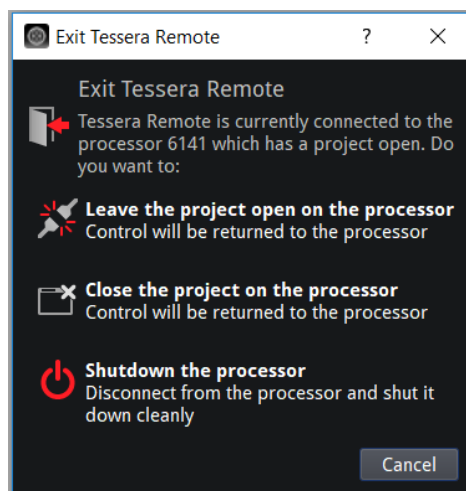

Figure 5-4. Tessera Remote, closing the app options

Disconnecting from the processor:

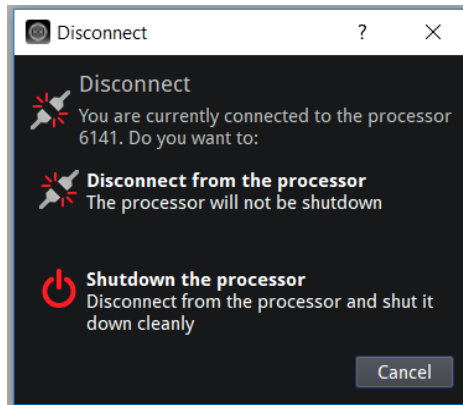

Figure 5-5. Tesseract Remote, disconnection from processor options.

- Clicking “Leave the project open on the processor” will return control to the processor’s local UI while keeping the project open.
- Clicking “Close the project on the processor” returns control to the processor’s local UI and closes the current project. The user will see the project management screen on the local UI.
- Clicking “Disconnect from the processor” returns control to the processor’s local UI.
- Clicking “Shutdown the processor” will shutdown the processor remotely. It will disappear from the network and won’t be accessible to the user however it will need to be powered down locally. The message “It is now safe to switch off the processor” is shown. A reboot button is located underneath this message if the user requires a reboot.

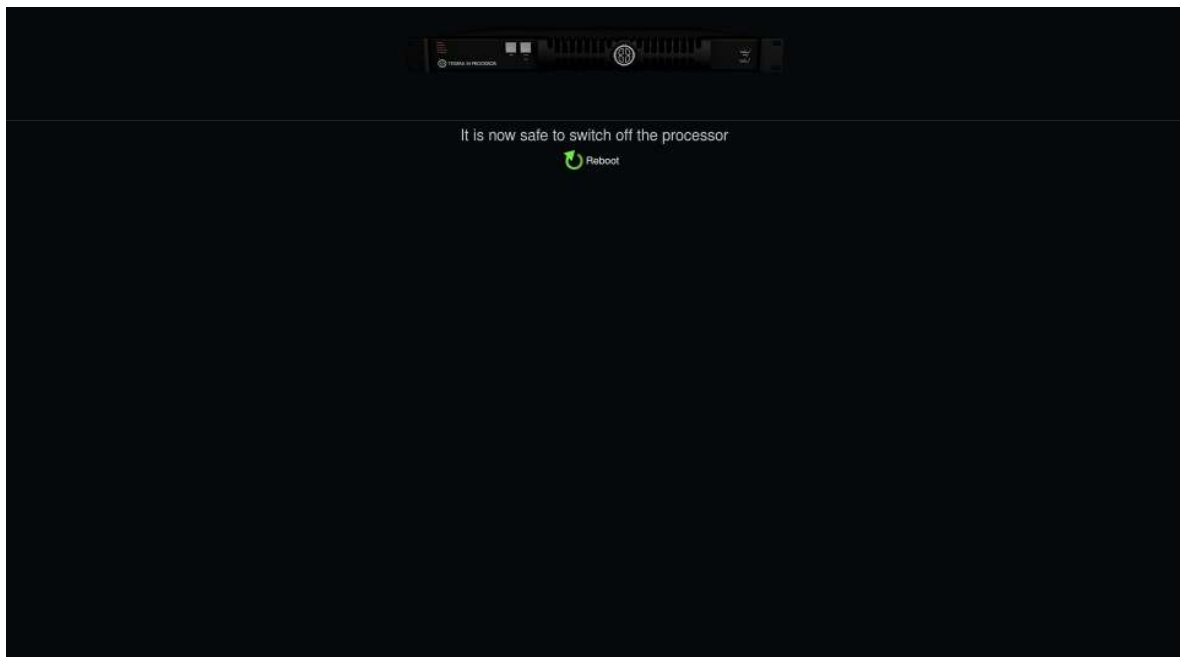

Figure 5-6. Processor shutdown screen

OFFLINE EDITOR

When using Tesseract Remote in Offline Editor mode, the user can modify projects without a processor. Offline Editor allows the user to create new projects, open previously created projects, or import projects from another location.

Drawing panels on the canvas using the “Add Fixture from Library” tool and other features are also available but limited until connected to a processor. See [“Creating A New Project in Offline Editor”](#) on page 41 and [“Add fixtures from library”](#) on page 58 for more details.

MULTIPLE PROCESSOR CONTROL

There are different approaches to control multiple processors:

Use a single Tessera Remote instance - It is easy to connect and disconnect from different processors on a network. The output from the processors will continue uninterrupted when Tessera Remote is not connected.

Use multiple Tessera Remote instances - Although Tessera Remote only supports connection to one processor at a time, it is possible to run several instances of Tessera Remote on the same computer for remote control of several processors from one device.

Use the Tessera Control application - Tessera Control provides a simple user interface for controlling multiple processors simultaneously. Controls available include Global colour, input colour and presets. See "[Tessera Control](#)" on page [154](#) for more information.

Use DMX and eDMX Control - Several control profiles are available and can be customised to control adjustments in colour, position, rotation, presets, etc. See "[DMX Control](#)" on page [152](#) for more information.

RUNNING MULTIPLE INSTANCES OF TESSERA REMOTE

When controlling multiple processors from one computer it is recommended to use a fixed IP address on each processor and on the computer running Tessera Remote. It can also be helpful to name each processor. See the section "[Identification](#)" on page [156](#).

Controlling different processors is then as straightforward as 'tabbing' (Alt + Tab in Windows, ⌘ + Tab in Mac OSX) to the relevant instance of Tessera Remote as required. Several monitors can also be used to control different instances at the same time.

Note - Mac OSX - To start Tessera Remote so that multiple instances can be run it is necessary to run Terminal in Utilities.

In Terminal, type: `open /applications/remote.app` then press Enter.

To run another instance of Tessera Remote type the following into Terminal:

```
open -n /applications/remote.app
```

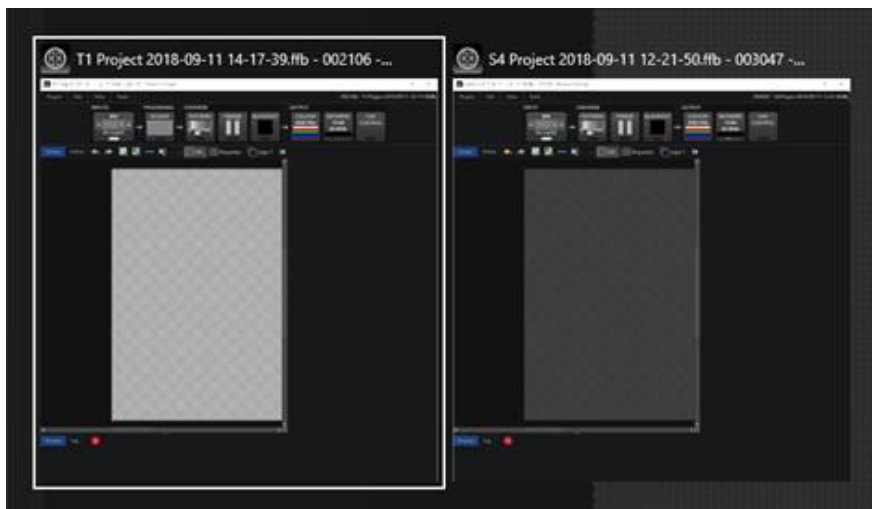

Figure 5-7. Alt-Tab to monitor or switch through multiple instances of Tessera Remote

CHAPTER 6 - PROJECT SETUP

PROJECT MANAGEMENT

OPENING AND IMPORTING PROJECTS

Select a project from the list then click Open from the left menu. You can also import projects from USB drives or the local computer storage drive.

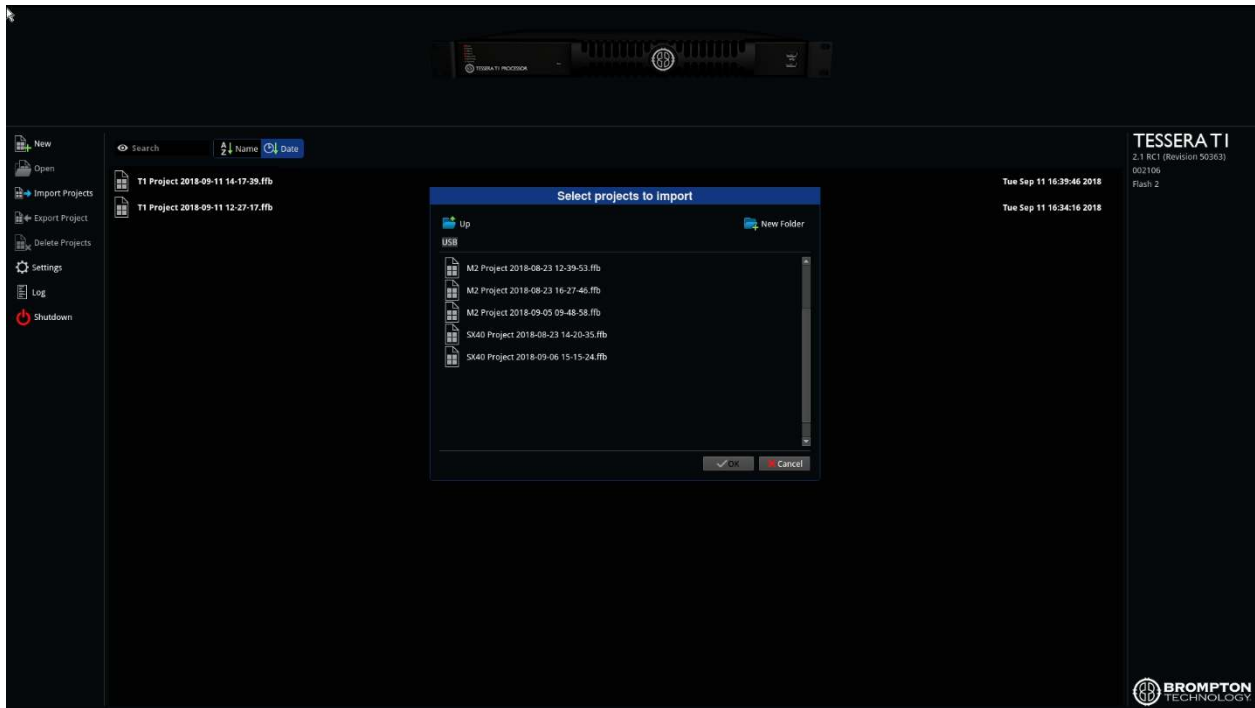

Figure 6-1. Importing projects in the project management screen

To import a project using the processor:

1. Insert a USB flash drive containing the project file into a USB port of the processor.
2. Click Import Projects on the project management screen to display the File Browser.
3. Navigate to a project file, select and click OK. The project file is copied and displayed in the list of projects stored on the processor.
4. Double click the file to open it.

To import a project while connected to the processor via Tessera Remote:

1. Click Import Project to open a file browser window and navigate to the project file stored on the computer.
2. Select the file and click OK. The project file is copied to the list of projects stored on the processor.

EXPORTING PROJECTS

In the remote app, to export a project stored in the processor, select the desired project from the project management screen and click Export project to select the location.

When a project is open, pressing Save as... is used to create a copy of the project and set it as the active project. Save a copy, creates and saves a copy of the project to the computer whilst keeping the current project open for editing.

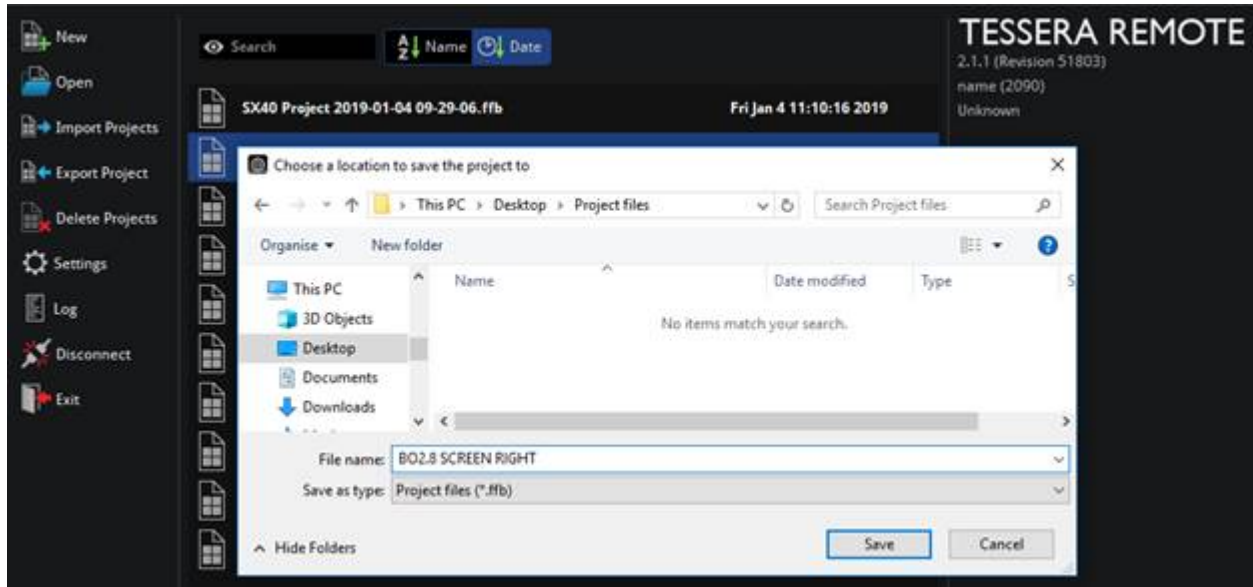

Figure 6-2. Exporting projects in the project management window.

In the Local user interface, projects can be exported to a USB drive.

1. Insert a USB flash drive into a USB port of the processor.
2. Click Export project on the project management screen to display the file browser.
3. Navigate to the desired location, make selection and click OK.

DELETING PROJECTS STORED ON THE PROCESSOR

1. From the project management screen, click to individually select projects and click Delete Projects to remove the file.
2. To delete multiple projects, hold Ctrl and use the mouse cursor to select multiple files.

CREATING A NEW PROJECT ON LOCAL UI AND TESSERA REMOTE

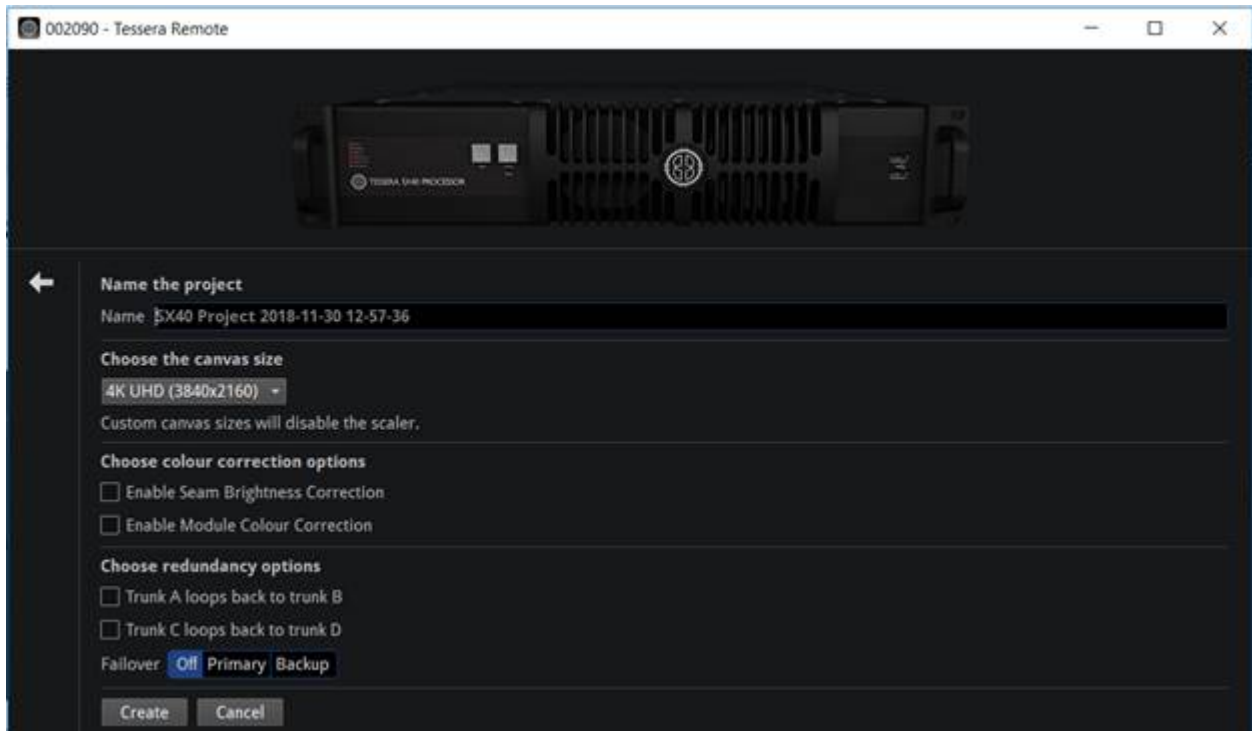

Figure 6-3. The New Project Window

To start a new project, select New on the project management screen. Once the New Project Wizard launches:

1. Enter a project name
2. Select a canvas size, Low Latency mode is automatically enabled on Tesseract T1 and M2 LED processors if canvas sizes other than 1920x1080 are used.
3. The Tesseract SX40 features custom resolutions, see "[Custom Canvas Resolution](#)" on page [Custom Canvas Resolution](#) for more information.
4. Seam Brightness, Module Colour correction, Low Latency Mode, and Loop/Processor Redundancy can be enabled from this menu.
5. Click Create to move to canvas edit mode.

The project is automatically saved to the processor's internal storage but can also be saved to a USB storage device. See "[Project Management](#)" on page [38](#) for more information.

CREATING A NEW PROJECT IN OFFLINE EDITOR



Figure 6-4. The offline editor's New Project Wizard differs from Remote and Local UI mode

To start a new project, select New from the menu on the Main screen. Once the New Project Wizard launches:

1. Select the processor platform where the project is to be used.
2. Enter a project name and the location for the project file to be saved to.
3. Select a canvas size, Low Latency Mode is automatically enabled on Tesseract T1 and M2 LED processors if canvas sizes other than 1920x1080 are used.

The Tesseract SX40 features custom resolutions, see "[Custom Canvas Resolution](#)" section on page [42](#) for more information.

4. Seam Brightness, Module Colour Correction, Low Latency Mode and Loop or Processor Redundancy can be enabled from this menu.
5. Click Create to move to canvas edit mode.

CANVAS RESOLUTIONS

Tessera systems allow the source to send any input resolution that fits within the canvas size, except when working at 2880x720 or 720x2880 in the HD processors.

Tessera M2/S4/T1

- The native canvas size for processors is 1920x1080 pixels
- The following list of non-standard canvas sizes are allowed, but places the processor in Low Latency Mode. See "[Low Latency Mode](#)" on page 43 for more information.
 - 1080x1920
 - 1600x1200
 - 2880x720 – This resolution requires the input to match the canvas size
 - 720x2880 – This resolution requires the input to match the canvas size

Tessera SX40

- HD 1920x1080
- DCI (4096x2160) or UHD (3840x2160) can be selected as native resolutions.
- Custom canvas resolutions are available. The scaler function is disabled.

Custom Canvas Resolution

Only available for the Tessera SX40, the user can enter a canvas size of their choosing, unrestricted by aspect ratio.

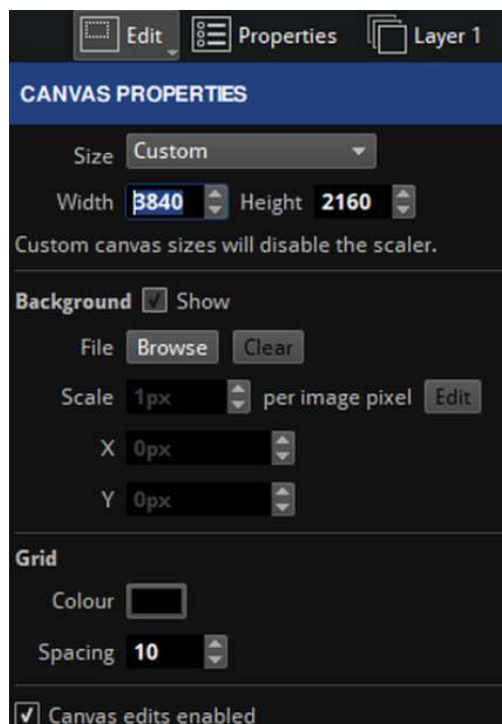

Figure 6-5. The Canvas properties, the user can adjust the canvas size on the fly

There are some rules to bear in mind when using custom resolutions.

- The scaler function is disabled
- Width:
 - Minimum: 720 pixels
 - Maximum: 4094 pixels
 - It must be an even value
- Height

- Minimum: 720 pixels
- Maximum: 4095 pixels
- The maximum total number of supported pixels is 8,847,460

Custom resolution settings should be thoroughly tested before being used in a production environment.

LOW LATENCY MODE

Low Latency Mode reduces the overall latency by one frame.

Tessera T1 and M2 LED processors work at a latency of 3 frames. In Low Latency Mode, the latency is reduced to 2 frames. Tessera S4 LED processors are always in Low Latency Mode, and non-standard canvas sizes automatically switch the Tessera M2 and T1 LED processors into Low Latency Mode.

Note - When using several processors with different end to end latencies to run the same wall, video delay needs to be modified. See "[Combining processors](#)" on page [29](#) for more information.

Working in this mode, the following features are disabled:

- Scaling (upscaling and downscaling). As a result, the active area modifications are disabled
- Deinterlace
- Frame-rate conversion, forcing the processor to lock to the source framerate

Colour functions, such as contrast, brightness and RGB gain remain unaffected. The input source is set at its default resolution and sync frequency and is positioned 1:1 in the top left corner of the canvas.

The Tessera SX40 LED processor does not have a Low Latency Mode, keeping all its features available at 2 frames latency end to end.

Note - We define latency (video delay) as time between the last cycle of a source frame appearing on the processor's input, and the first cycle that an LED on a fixture is lit with that frame.

MAPPING OPTIONS

Interpolation can be activated from the Canvas properties. Tessera projects can be set to work in two different mapping modes depending on the requirements. See "[Canvas Properties](#)" on page [78](#) for more information.

When working in 1:1, the physical size and pixel pitch is not taken into account, every pixel is sent to the correspondent position, independently of the fixture size.

In Interpolated mode, the physical size of panels is accounted for, interpolating every pixel to match the size of different panels, keeping the proportions of the image.

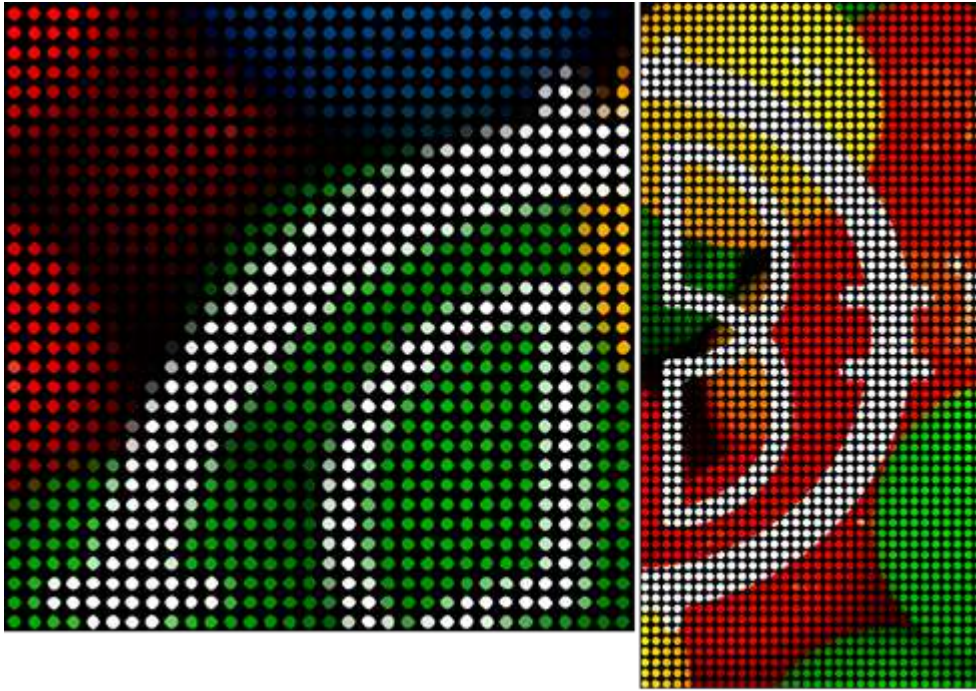

Figure 6-6. Fixture output in 1:1 mode

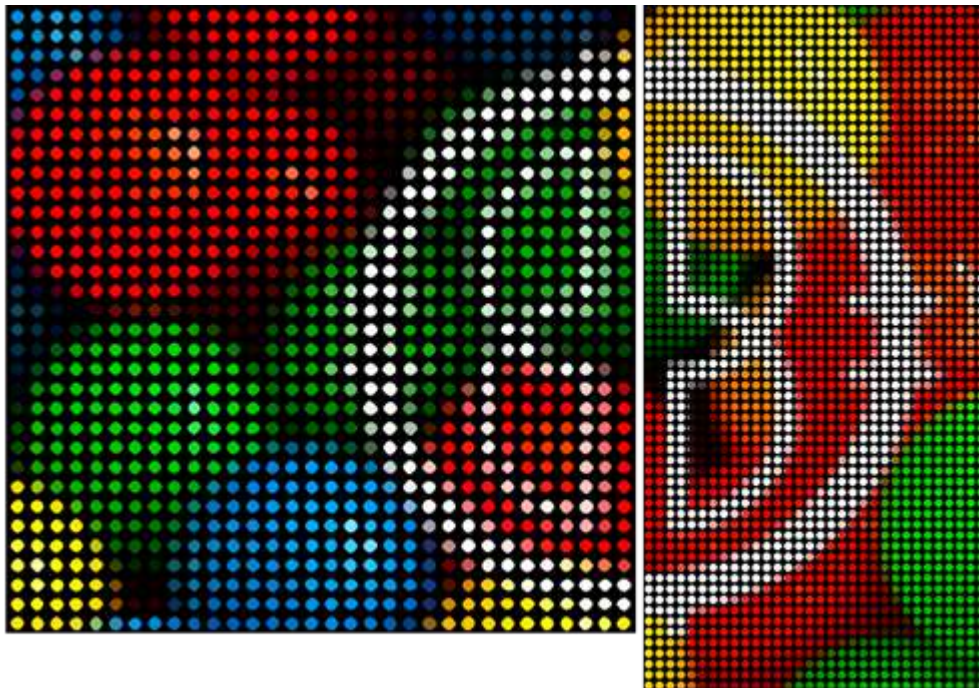

Figure 6-7. Fixture output in Interpolated mode

PORT CAPACITY IN 1:1 OR INTERPOLATED

When using 1:1 mapping, the output capacity is not affected.

In interpolated mapping, the content on fixtures with a coarser pixel pitch is scaled to take the panel size into consideration, so that content appears the same size across all fixtures.

For example, assume we have a project with three fixture types:

- Type A: 5mm pitch, 500mm x 500mm physical size, $100 \times 100 = 10,000$ pixels
- Type B: 7.8mm pitch, 500mm x 500mm physical size, $64 \times 64 = 4096$ pixels

- Type C: 15.6mm pitch, 1000mm x 500mm physical size, 64 x 32 = 2048 pixels

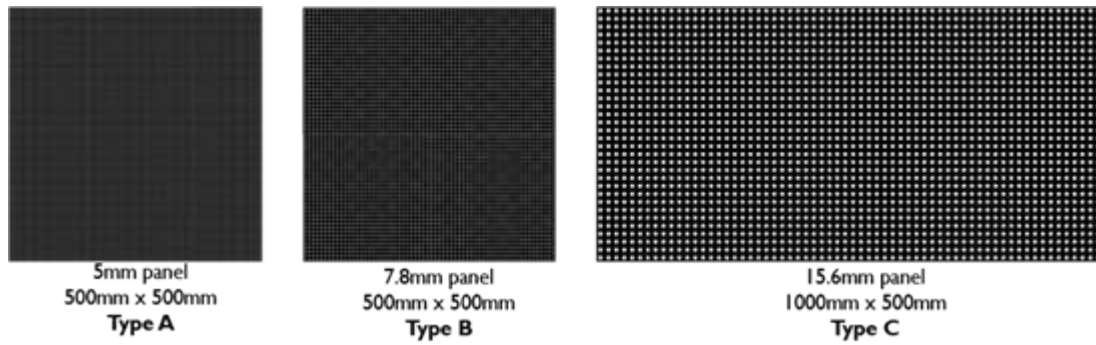

Figure 6-8. Different pixel pitch fixtures

	Real Pixel Count	Size (mm)	Pixel Count Interpolated	Pixel Count 1:1
A	10,000	500x500	10,000	10,000
B	4096	500x500	10,000	4096
C	2048	1000x500	20,000	2048

Fixture type A counts 10,000 pixels towards the capacity regardless of whether interpolated mapping is used as it has the finest pixel pitch.

With 1:1 mapping, each fixture of type B would count 4096 pixels towards the capacity limit, but with interpolated mapping it counts the same as a type A fixture of the same size, so 10,000 pixels. Fixture type C is the physical size of two type A fixtures, so counts 20,000 pixels towards the limit.

COLOUR AND BRIGHTNESS

There are several ways to modify colour and brightness of fixtures connected to the Tessera system. The controls to use depends on the source or the creative effect desired.

- Global colour - The controls on the Colour Pipeline Tile affects all fixtures connected to the processor, except where per-fixture or per-group overrides are active. See "[Global Colour](#)" on page [124](#) for more information.
- Per-fixture and per-group colour override - Colour and brightness settings can be superseded for specific fixtures or groups by enabling Override Global Colour on the Fixture Properties editor. See "[Per-fixture and Per-group Colour Override](#)" on page [47](#) for more information.
- Input colour - provides controls for modifying the colour balance of a specific input (DVI, SDI, HDMI or analogue). See "[Input Colour Control](#)" on page [102](#) for more information.
- On-Screen Colour Adjustment (OSCA) –OSCA provides a way of compensating for colour mis-matches between modules and the appearance of bright or dark seams. See "[On-Screen Colour Adjustment](#)" on page [130](#) for more information.
- ChromaTune - ChromaTune provides tools for making more precise tweaks to specific colours in an incoming video feed. See "[ChromaTune](#)" on page [115](#) for more information.

CHAPTER 7 - FIXTURES

FIXTURE LIBRARIES

To correctly communicate with fixtures, the processor needs to have the fixture firmware included in the fixture library. A fixture pack is installed with every version of the processor's firmware and updated fixture packs can be found on our website. See "[Fixture Library](#)" on page [161](#) for more information.

FIXTURE PROPERTIES

When selecting an online fixture from the canvas or from the online tab, the Fixture property editor appears. The property editor sections are divided into Fixture, Colour and Device. See "[Properties Area](#)" on page [86](#) for more information.

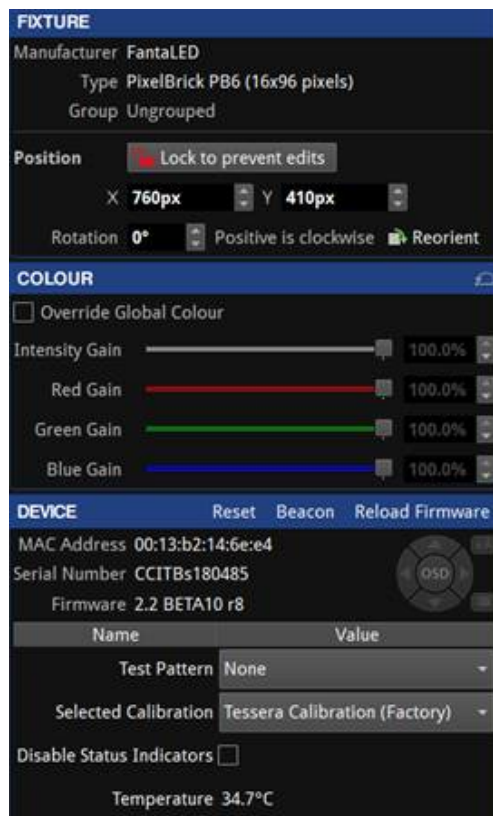

Figure 7-1. Fixture property editor

FIXTURE

Fixture displays basic information about the selected fixture including manufacturer, fixture type and the name of the group containing the fixture.

The second section of this editor displays the position and rotation of the fixture on the canvas. Modifications can be made by typing or using the spin box arrows. Changes can be locked to avoid modifications. Reorient rotates square fixture by 90 degrees clockwise, rectangular fixtures are re-oriented by 180 degrees.

COLOUR

Colour modifications can be enabled in the selected fixture independently from the Global Colour. When the Override Global Colour box is ticked, colour modifications for the selected fixture are enabled and Global Colour property editor values have no effect on the fixture.

PER-FIXTURE AND PER-GROUP COLOUR OVERRIDE

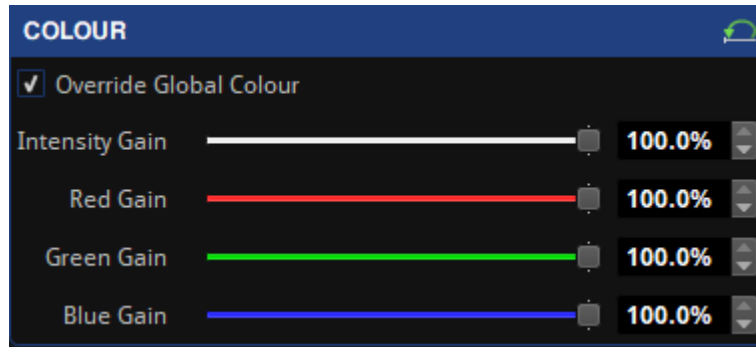

Figure 7-2. Global Colour Override options in Colour property editor

Single fixtures or groups of fixtures can be made exempt from Global Colour control and assigned separate values. This is useful to maintain one screen at a constant brightness when other fixtures are grouped into separate screens on a processor.

To Override Global Colour, select the fixtures or groups to override and choose from options from the property editor. Different options are made available depending on the users selection.

- If the selection is an ungrouped fixture or a combination of fixtures/groups, the options that can be adjusted are:
 - Intensity gain
 - Red gain
 - Green gain
 - Blue gain
- If the selection is a group, the options that can be adjusted are:
 - All the previous settings
 - Brightness
 - (Colour) Temperature
 - Gamma

Note - Once a selection has been overridden on the Colour property editor, the Global Colour controls have no effect on the selected fixtures until the checkbox for Override Global Colour is unchecked.

DEVICE PROPERTIES

The device property editor shows information stored on the R2 receiver card.

FIXTURE QUICK ACCESS BUTTONS

In the title bar for the Device property editor, there are three quick access buttons:

- **Reset:** Reboots the fixture, video will stop displaying in the following devices connected in the same string, as data is not passed through while the fixture is rebooting.
- **Beacon:** Activates the “Identify” test pattern, also called beacon, for the selected fixture. This can be used to identify the panel from the back. While the panel is in beacon, the rear status indicator LED of the panel blinks yellow.



Figure 7-3. A beacons panel showing the Identify internal test pattern

- **Reload firmware:** Re-applies firmware for selected fixtures from the prioritised pack in the Fixture Library. See “[Fixture Library](#)” on page [161](#) for more information.

DEVICE INFORMATION

The first section lists the MAC address, serial number and firmware version information of the R2 receiver card. The OSD property editor can enable and control OSD shown on selected fixtures See “[OSD](#)” on page [50](#) for more information.

TEST PATTERN

The Test Pattern drop-down menu allows the user to select a range of internal test patterns that are pre-programmed within the fixtures R2 receiver card. These patterns are viewable regardless of whether the fixture is associated to the processor or not.

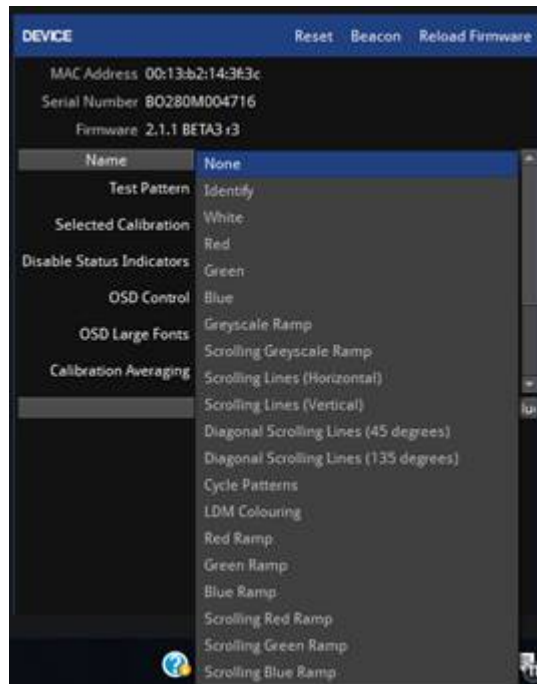

Figure 7-4. Internal Test Pattern drop-down menu

Although fixture models vary, most fixtures have a self-test button on the back of the fixture which can be used to activate test patterns by holding on the button for 4 seconds. (Refer to fixture manufacturer documentation for specific functionality).

SELECTED CALIBRATION

The Selected Calibration drop-down menu allows the user to select between the different calibration profiles that are stored within the fixture's R2 receiver card.

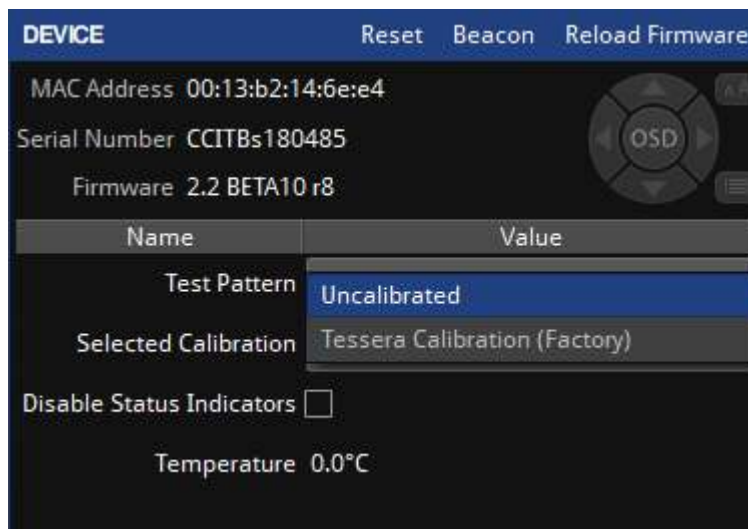

Figure 7-5. Selected Calibration list

DISABLE STATUS INDICATOR

The status indicator of the root nodes can be disabled if necessary, by toggling the tick box.

SENSORS INFORMATION

Information from sensors such as temperature or humidity is displayed if available in the fixture.

OSD

OSD or On-Screen Display is supported on R2-based fixtures and offers the possibility to display information on the fixture itself, the processor or the project.

Note - OSD is supported on rectangular fixtures with a minimum size of 64x64 pixels but no larger than 1024 pixels in either dimension and up to 262,000 pixels (e.g. 512x512, 1024x256, etc.)

Note - RA-16 based fixtures are not supported

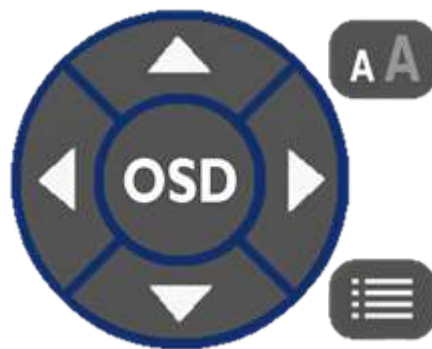

Figure 7-6. OSD controls

To access OSD, click on or select multiple fixtures to reveal the Fixture properties editor.

Click on the OSD button to activate, click again to deactivate. To navigate OSD, use the left and right arrows to cycle through categories, and use the up and down arrows to cycle through pages within each category.

If viewing OSD from a distance, it can be useful to use enlarged fonts by pressing the size button **A A** next to the OSD buttons. Fixtures must have a minimal of 128x128 pixels to use this feature.

To trigger OSD from using the rear self-test button on the back of a fixture, press and release the button three times. OSD is only applicable to fixtures running firmware Tessera version 2.1 and above.

STUDIO MODE

Studio Mode reduces a fixture's maximum brightness while maintaining the PWM bit depth, thereby resulting in improved image quality (with less banding) when running at low brightness. The maximum benefit is seen on particularly bright fixtures, especially those running at relatively low PWM bit depth (14 bit or below). See [Studio mode](#) on page [129](#) for more information.

For fixtures supporting this feature, Studio Mode can be enabled or disabled using the Studio Mode checkbox.

Below are some comparison images showing the advantages of Dark Magic and Studio Mode.

Normal (no Dark Magic or Studio Mode)

Banding clearly visible at the low end of the gradient



Dark Magic (only)

Banding eliminated, some slight 'sparkle' visible

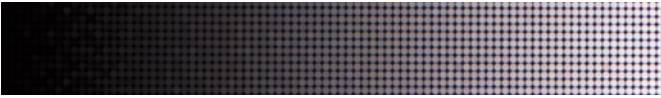

Studio Mode (only)

Banding less pronounced, but still visible



Dark Magic and Studio Mode

No banding and reduced sparkle

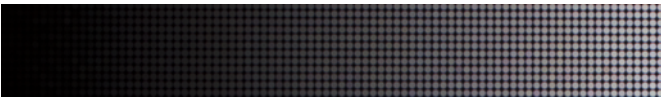

FIXTURE CONTEXT MENU

Right-click a fixture to open a context menu with a list of options. These options are grouped by type and some options have keyboard shortcuts displayed on the right side column. If a fixture is un-associated, some options are unavailable.

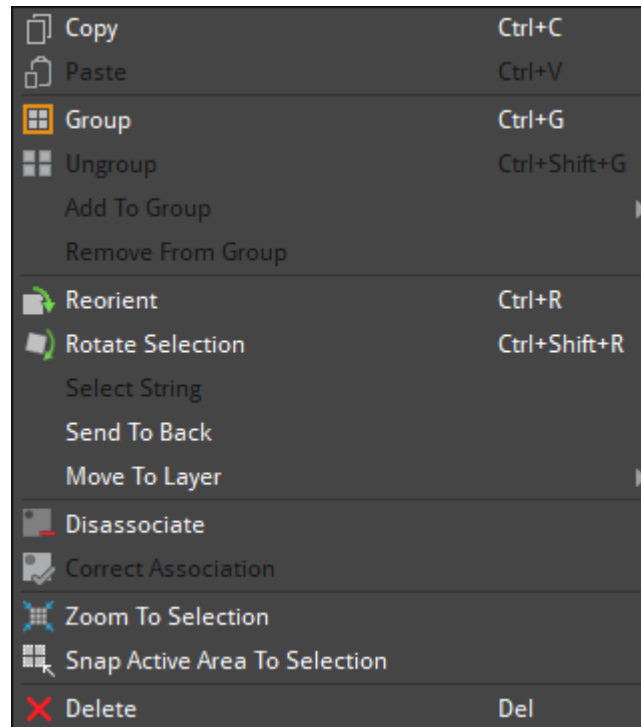



Figure 7-7. Fixture context menu options

Function	Description
Copy	Copy the selected fixtures
Paste	Place the copied fixtures in the canvas The rotation value is also added but other values such as the modifications in the fixture Colour property editor (see “Fixture Properties in page 46”) are not copied into the new fixture.
Group	Make a group with the selected fixture/fixtures. Grouping fixtures is necessary to create group presets or to control fixtures properties via DMX or eDMX protocols.
Ungroup	Break the selected group/groups. Please note that ungrouping deletes the group information (name, colour, etc) and movement records of the selected group in all relevant presets.
Remove from group	Removes the selected fixture from a group without breaking the group. To select one or several fixtures from a group, hold the Shift key while selecting the fixture/fixtures.
Reorient	Rotates square fixtures around their own axis by 90° and rectangular fixtures by 180°
Rotate selection	Rotate the selected fixtures around the selection’s axis
Select string	Select all the fixtures connected to the same string as the one selected
Send to back	Send to the back of the z-axis of the selected layer. Please note that, above the z-axis order in a layer, the order of layers determine which fixtures can be seen on top
Move to layer	Move the selection to a layer
Disassociate	Remove the association of the selected fixture
Correct association	Fix the topology re-associating fixtures
Zoom to selection	Fits the canvas zoom to display the selected fixture/fixtures
Snap active area to selection	Applies the scaler to fit the active area to the selected fixtures
Delete	Delete the selected fixture/fixtures

ADDING FIXTURES TO A PROJECT



There are two main workflows for adding fixtures to a project.

- With fixtures connected to the processor. The project and fixture layout are created on a processor with fixtures physically connected. In this case use Add Fixtures from Network 
- Without fixtures connected to the processor (or in offline mode). If a fixture is not connected, select Add Fixture from Library  to access the fixture library containing all fixtures packs that are currently installed on the processor.

See "[Fixture Library](#)" on page [161](#) for more information.

Users can use whichever workflow is most convenient for their project, including a combination of the two.

ADD FIXTURES FROM NETWORK

On the toolbar above the canvas space, the circular indicator on the Add Fixtures from Network  button is greyed out if fixtures are not detected or not connected to the processor. This feature is not accessible until fixtures are physically connected and detected by the processor. Once detected, the indicator turns green. 

After clicking Add Fixtures from Network, the toolbar displays detected fixtures and strings of fixtures grouped by output ports. A string is a continuous daisy-chain of Tessera compatible fixtures.

Associating Fixtures

There are two ways to associate fixtures:

Quick association

When fixtures are connected to the processor, each string is assigned a unique numeric code. Entering the code on the processor (using number keys or numpad) selects the corresponding string, the string then has the first fixture attached to the cursor for placement on the canvas.

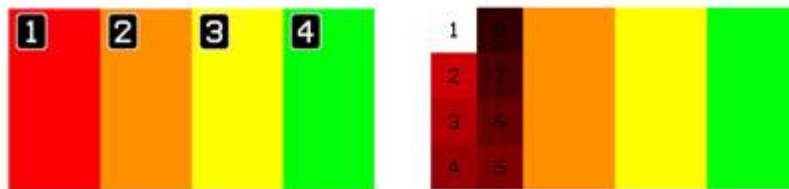

Figure 7-8. This figure shows a connected fixture wall output. The left image shows a numeric value corresponding to the fixture when entering Associate Fixtures from Network. The right image shows when a numerical value has been entered in the processor

Note - This feature is only supported by R2-based fixtures with at least 64x64 pixels.

Note- When the processor recognizes more than 9 strings attached, string numbers have more than one digit, therefore strings must be entered with the same number of digits as the number of the last string detected. e.g. 01 or 005.

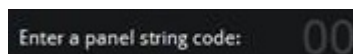

Figure 7-9. Use the keyboard to enter the shown number on fixture string to add to canvas

Mouse selection association

Associating fixtures can also be done by selecting the port. All fixtures connected to each port are highlighted with the same colour. For example, on a Tessera M2 LED processor, the fixtures on output 1 are always highlighted in red. Similarly, when selecting a port on a root node, the ports is always highlighted in the same colour such as port 1 is always red.

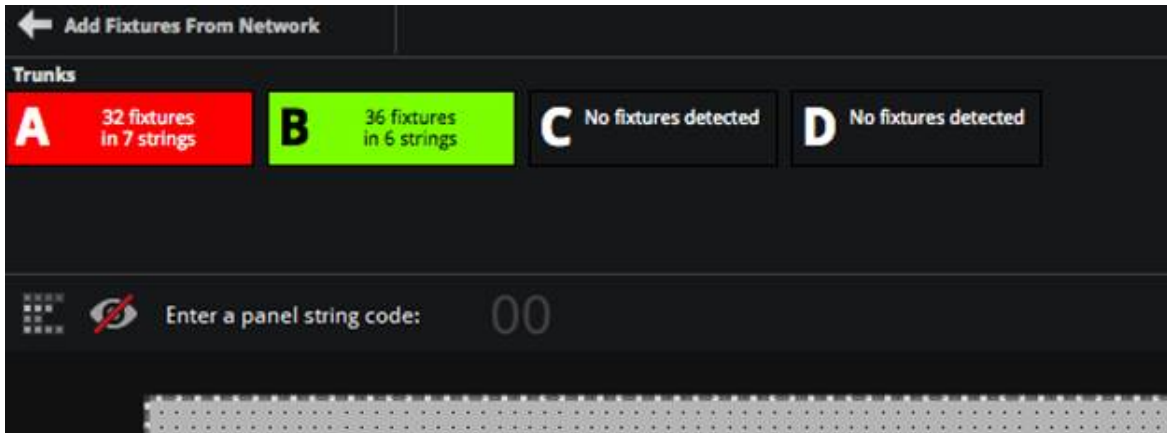

Figure 7-10. Click on either port A or B to associate to canvas



Figure 7-11. Tessera SX40 with XD units, select one to associate to canvas

When associating by selecting ports for each string, the string is represented by a unique colour in the user interface and physical fixtures. Fixtures illuminate corresponding to identified strings.

- The Tessera T1 LED processor only has a single output port so there is no port selection and only displays available strings of fixtures.
- For the Tessera SX40 LED processor, the user needs to first select the trunk where the XD is connected before continuing to ports compared to other processors.
- During fixture association, if the string contains multiple types of fixtures they are illustrated in the user interface, and the current part of the string is highlighted.

Blind mode

Blind association  is available to associate fixtures without highlighting. This feature can be toggled on/off in Add Fixtures from Network view. To enter this mode with fixtures remaining in this state, hold the Alt button when clicking on Add fixtures from network .

Rotation

Fixtures can be rotated before being placed on the canvas. Use the Rotation slider on the Draw Array property editor or alternatively use Alt + mouse wheel to modify the rotation angle.

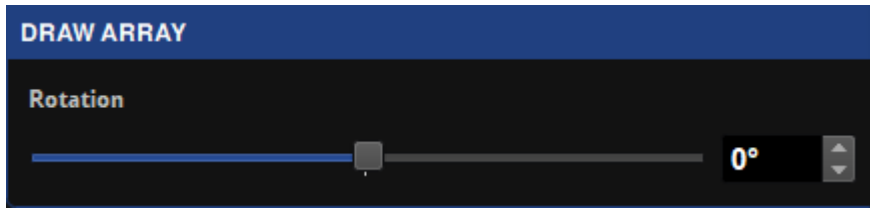

Figure 7-12. Draw array feature for rotating fixtures before placing

Array types

To place an array of fixtures, hold the left mouse button while placing the fixture. The array is direction sensitive and topology changes depending on which direction the mouse is dragged.

Topology can be adjusted or re-assigned later from the Canvas view using the Topology tool.

Once an array is created, the Add Fixtures property editor is shown with the following options:

Group Fixtures

Groups the array that the user has created.

For Tessera M2 and T1 LED processors, there are 3 types of array layouts: Grid, Circle and Radial.

Note - Tessera SX40 or S4 LED processors only support grid arrays, circle/radial are not available.

Grid arrays

The Grid Add Fixtures property editor contains options for the user to adjust position, change grid size, define spacing between fixtures or rotate to a desired location.

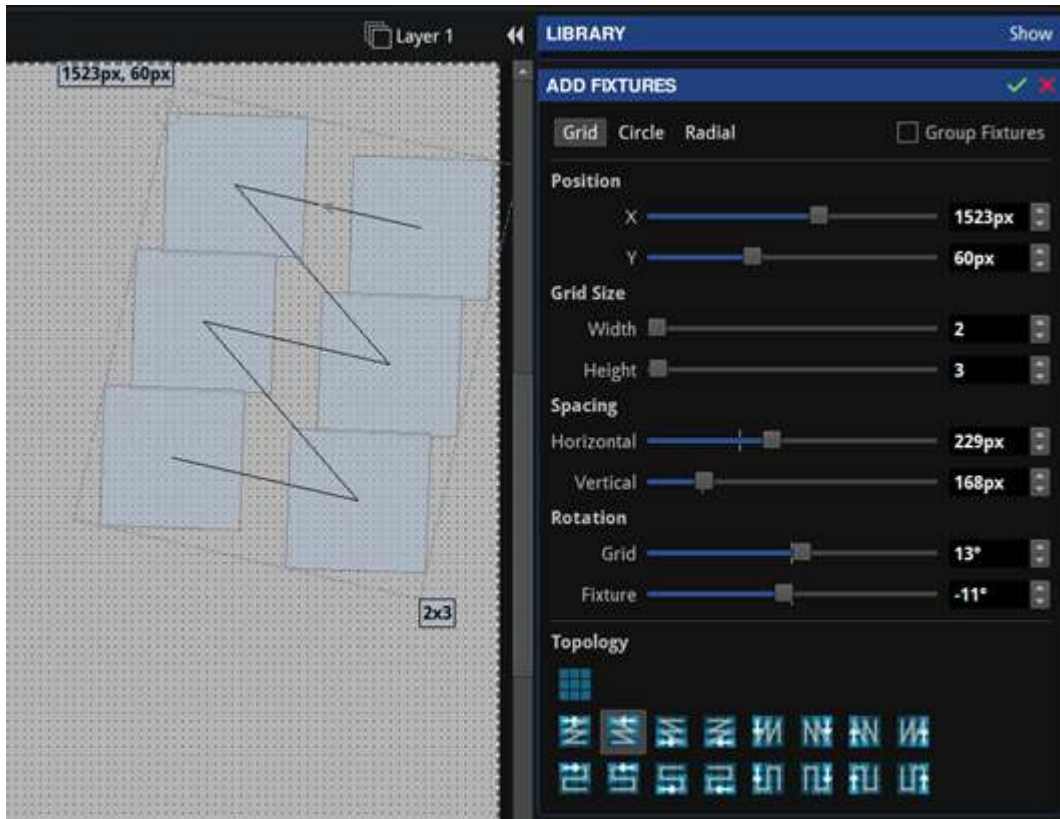

Figure 7-13. Grid fixture layout property editor

Circle arrays

The Circle Add Fixtures property editor contains options for the user to place fixtures in a circular array. The radius, position, rotation and fixture count can be changed.

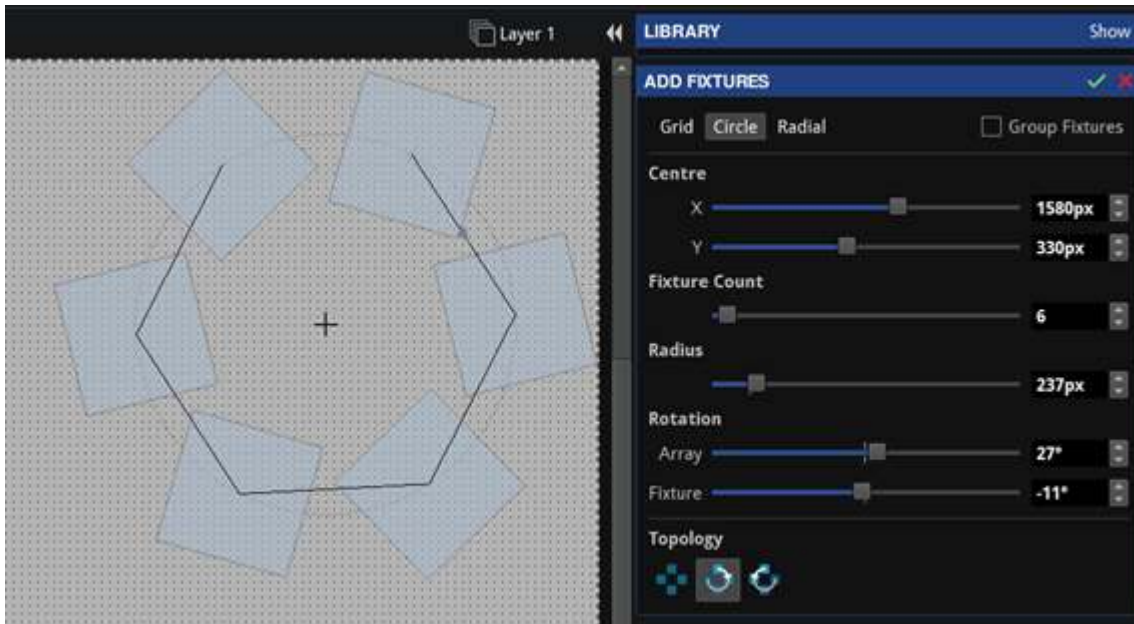

Figure 7-14. Circle fixture layout property editor

Radial Arrays

Differs to the circle option by offering the option to place multiple fixtures in a circle, spanning outwards to create a wider display. Unique options with Radial include adjusting the quantity of fixtures used per spoke, the width and distance between fixtures.

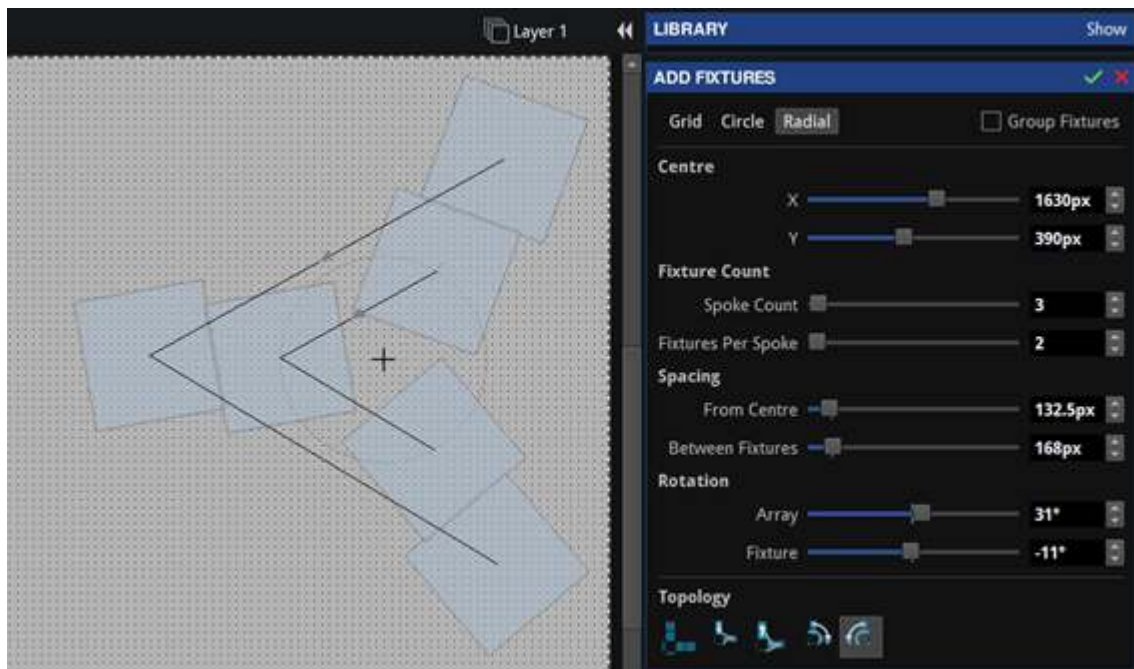

Figure 7-15. Radial fixture layout property editor

ADD FIXTURES FROM LIBRARY

It is possible to work offline and create a layout when fixtures are not connected either by using the Tessera Offline Editor in Tessera Remote, or by using the local user interface. In each case the user will need to add fixtures from the library, as no fixtures are connected so Add Fixtures From Network will be disabled.

Add Fixtures from Library displays the Fixture Library and Draw Array Fixture editor, allowing the user to draw fixtures to your project's utilizing the installed fixture packs available on the processor or on Tessera Remote.

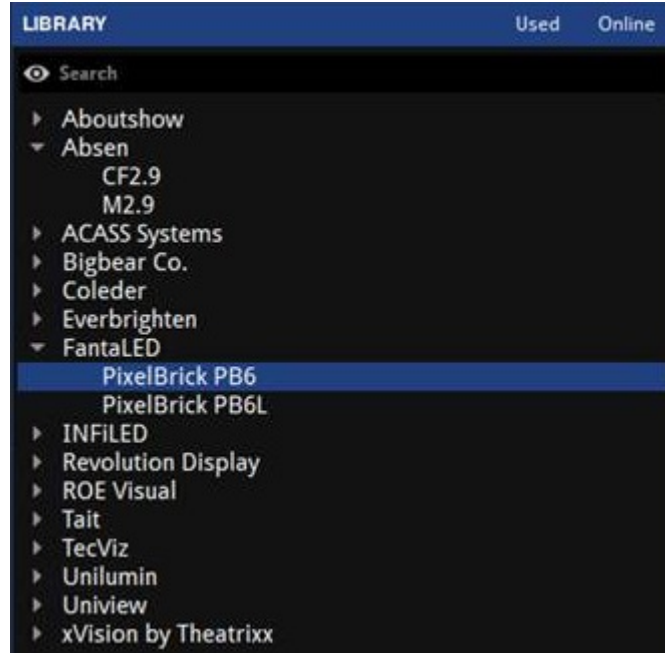

Figure 7-16. Fixture library with list of installed fixture firmware on the processor

The Search bar can be used to filter the list or find a specific fixture. To only display fixtures that are already placed on the canvas, select Used in the top-right corner. Similarly, to only show connected fixtures click Online to reduce the list to fixtures types that are connected to the processor.

Select a fixture from the list and click on the canvas to add the fixture.

ASSIGNING OR MODIFYING ONLINE FIXTURE TOPOLOGY

To associate a fixture already placed on the canvas:

Click the relevant fixture on the canvas.

1. If the fixtures on the canvas already have topology applied, the user is prompted to associate the rest of the string using the highlighted red string. Press enter to associate the fixture to the string.
2. If only part of the string is required, hold the Shift key and select the last fixture to associate.
3. Alternatively, continue to associate fixtures individually by clicking each fixture on the canvas in turn.

If the user creates a new topology for panels which have already been associated, the old topology will be discarded in favour of the new topology/association.

See "[Understanding Topology and Association](#)" on page [66](#) for more information.

SUB-FIXTURES

Sub-fixtures do not have a Tessera interface and so cannot be connected directly to a Processor or XD output. Instead multiple fixtures are connected to a single power/control box. These fixtures are represented in the Tessera system as sub-fixtures. The power/control boxes are called root nodes.

Each root node contains a R2 receiver card, and like normal panel-type fixtures are connected to the rest of the system over daisy-chained Gigabit Ethernet. Root nodes connect to sub-fixtures using a proprietary data/power connection.

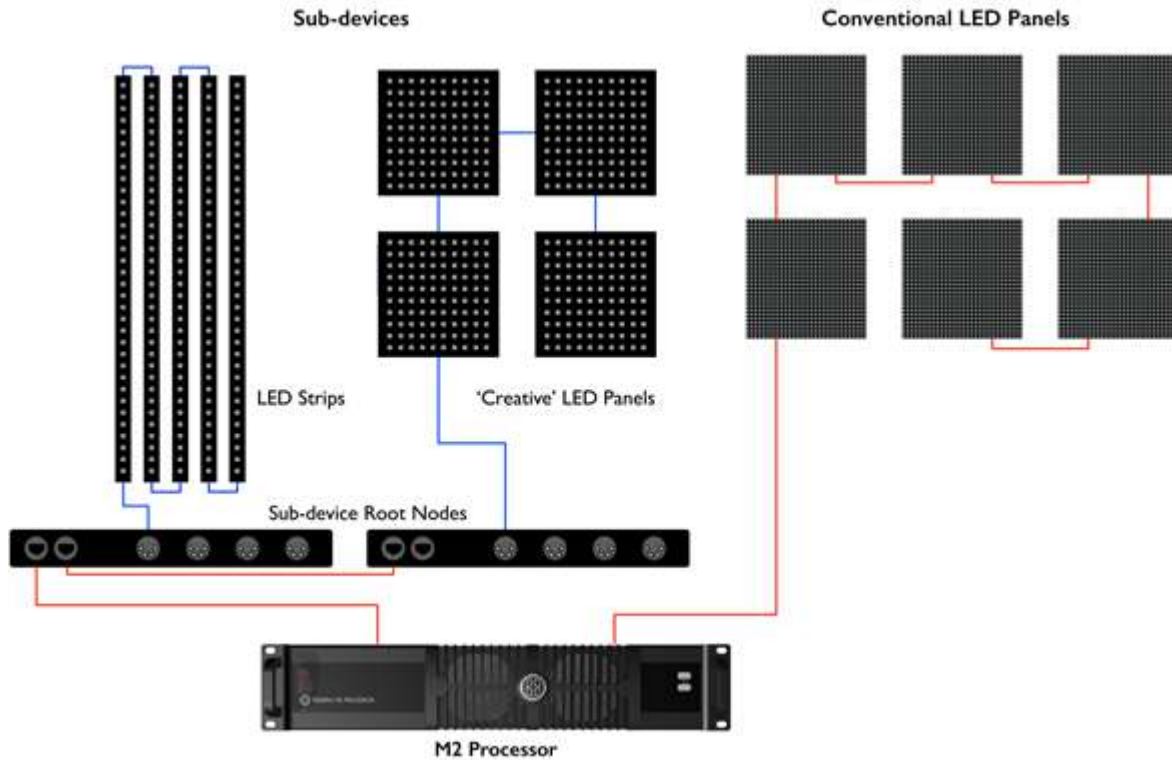

Figure 7-17. Sub-fixtures being used with conventional LED panels

Note - Sub-fixtures are supported on Tessera SX40 version 2.3 and upwards.

SUB-FIXTURES PROPERTIES

The Fixture property editor is displayed when selecting an online root node or sub-fixture from the canvas or the online view. See "[Fixture Properties](#)" on page 46 for more information.

ROOT NODES PROPERTIES

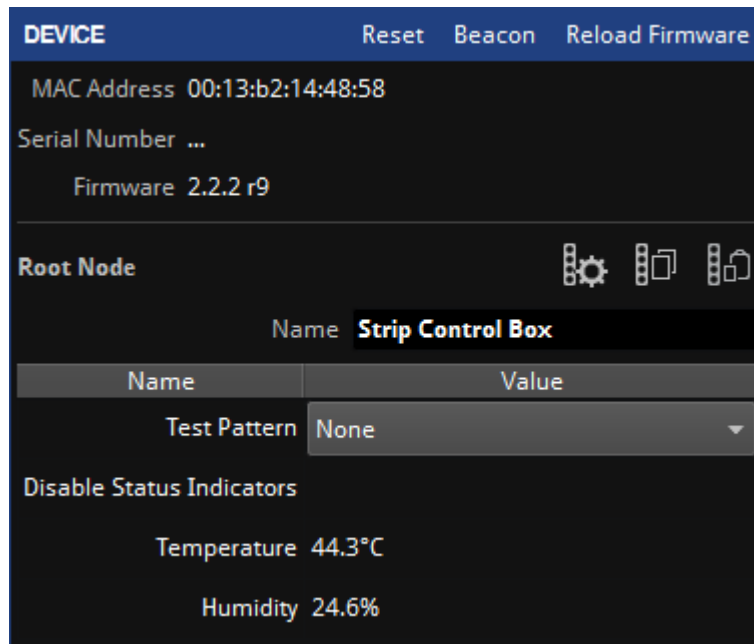

Figure 7-18. Device property editor

The device property editor shows the information of the R2 receiver card and the root node.

Device Information

The first section lists the MAC Address, serial number and firmware version information of the R2 receiver card.

Note - OSD is not available for sub-fixtures. See "[OSD](#)" on page [50](#) for more information

Configuration Buttons

Next to Root Node there are three buttons:

- **Configure root node**

Allows the user to specify sub-fixtures on each port. See the "[Configuring the root nodes online](#), steps 5 and 6" on page [62](#) for more information.

- **Copy root node configuration**

Copy the configuration for the selected root node.

- **Paste root node configuration**

Paste the copied configuration for the selected root node.

Using Copy/Paste can make the workflow quicker when using larger amounts of root nodes. Several root nodes can be selected, and the configuration pasted to all of them at the same time.

Test Pattern

The Test Pattern drop-down menu allows you to select a range of internal test patterns that are generated on the fixtures R2 receiver card. The patterns can be displayed on all connected sub-fixtures whether they are associated to the processor or not. See "[Sub-fixture internal test patterns](#)" on page [65](#) for more information.

Disable Status Indicator

The status indicator of the root nodes can be disabled by toggling the tick box.

Sensors Information

Information such as Temperature or Humidity is displayed if the root node has the appropriate sensors.

SUB-FIXTURES CONTEXT MENU

Right-click the root node to open a context menu with a list of options. Sub-fixture options are the same as other fixture's options. Root nodes have additional functions to "Configure" (only when the root node is online) and "Add Sub-fixtures" options for root node configuration and the addition of sub-fixtures.

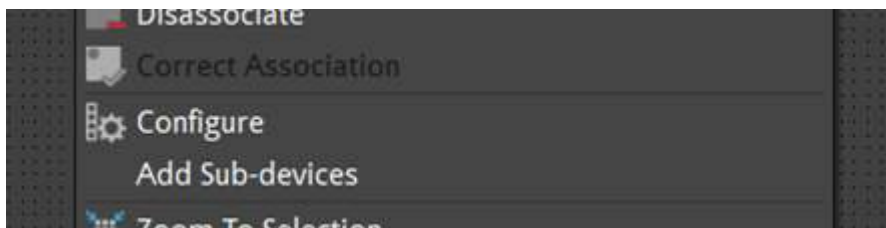

Figure 7-19. Extra option for sub-fixtures in context menu

ASSOCIATING SUB-FIXTURES

Sub-fixtures may be individually positioned and rotated on the canvas, just like normal fixtures. Root nodes are not typically able to detect what types and quantities of sub-fixtures are connected to their outputs and must be assigned by the processor. Root nodes can be added to the canvas using the Add Fixtures from Library or Add Fixtures from Network tools.

ADDING SUB-FIXTURES ONLINE OR OFFLINE

Using Add Fixtures from Library or Add Fixtures from Network

1. Click Add Fixtures from Library or Add Fixtures from Network
2. Select the root node and place it on the canvas.
3. Press Enter to return to the Canvas view.
4. Right-click the root node and select Add Sub-fixtures.
5. The type of fixture can be selected from the Library list. Select the relevant sub-fixtures and add them to the canvas.
6. Repeated presses of Tab or the Next Port button advances through the ports, before returning to adding root nodes.



Figure 7-20. Adding a sub-fixture to canvas

7. Repeat steps 5 and 6 until all fixtures are placed.
8. Press Enter or Escape to confirm the association
9. If the configuration of the root nodes does not match the fixtures on the canvas, a notification is displayed. Click the button to confirm.

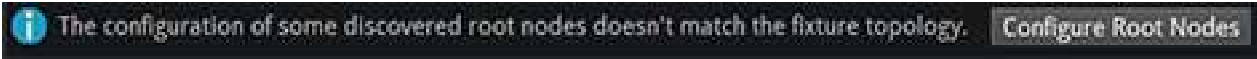

Figure 7-21. Notification to configure root nodes not matching fixture topology

CONFIGURING THE ROOT NODES ONLINE

Using Add Fixtures from Network . The root nodes need to be connected to the processor and online.

1. Click Add Fixtures from Library or Add Fixtures from Network
2. Select the root node and place it on the canvas.
3. Press Enter to return to Canvas view.
4. Right-click the root node and select Configure. A new window opens with the root node configuration options.

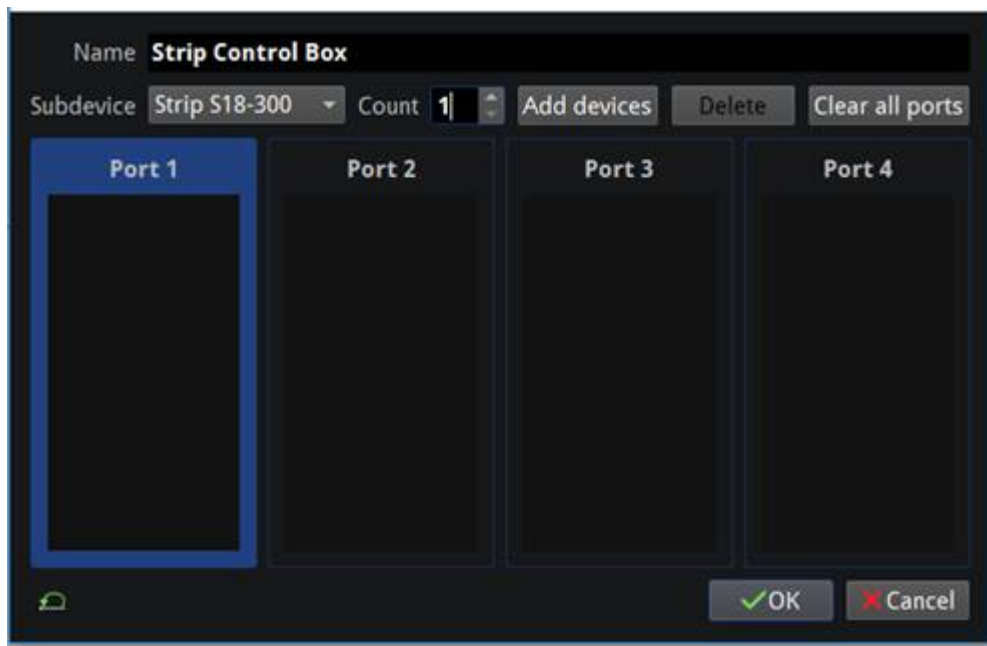

Figure 7-22. Strip control box configuration menu

5. The control box stores the last configuration from previous projects. To delete all associated sub-fixtures click Clear all ports or to delete individual sub-fixtures, select and press the delete button.
6. Select the port, sub-fixture type and the number of sub-fixtures then click Add devices. This may take a couple of seconds for the root node to configure.

Once configured, sub-fixtures can be added. If the topology differs from the root node configuration, root nodes can be reconfigured by pressing the Configure Root Nodes button in the error message.

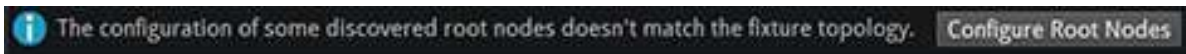

Figure 7-23. Notification to configure root nodes not matching fixture topology

OFFLINE

Using Add Fixtures from Library

1. Click Add Fixtures from Library.
2. Select the root nodes and place on the canvas. The search bar can be used to filter fixtures.



Figure 7-24. Adding a Root node to canvas

3. Press Tab to start associating sub-fixtures. Repeated presses of Tab or the Next Port button advances through the ports.
4. The type of fixture can be selected from the Library menu. Select the sub-fixtures and add them to the canvas.



Figure 7-25. Adding a sub-fixture to canvas

5. Repeat steps 3 and 4 until all your fixtures are placed.
6. Press Enter or Escape to confirm the association.

Once fixtures are connected to the processor, the root nodes can be associated. Strings of root nodes appear the same as strings of normal fixtures in the Add Fixtures From Network tool. See ["Adding Fixtures to a Project"](#) on page 53 for more information.

When a root node is associated, its outputs is automatically reconfigured with the correct types of sub-fixtures drawn in the topology, and sub-fixtures are automatically associated.

ONLINE

Using Add Fixtures from Network

This option restricts the addition of sub-fixtures to the configuration of the root node. The processor does not receive information regarding the number of connected sub-fixtures.

1. Click Add Fixtures from Network
2. Select the port for connected fixtures.
3. Select the root node and associate it to the canvas. This step is not necessary but is useful if the root node configuration needs to be changed.
4. Select the sub-fixtures.

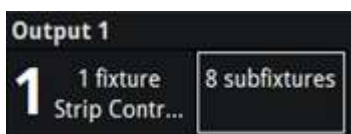

5. Select the root node where the sub-fixtures are connected.



6. Select the port connected to the root node for association.

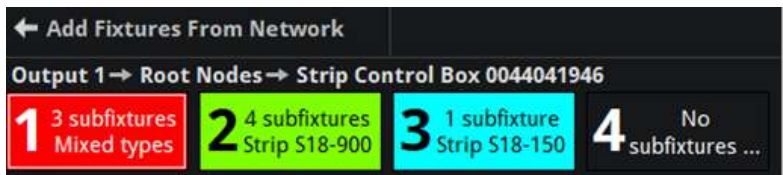

- 7. Draw the sub-fixtures of the selected port on the canvas and continue to other connected ports.
- 8. Press escape to get to the previous menu or enter to finish association and return to Canvas view.

If the configuration is correct, all sub-fixtures are now ready for use.

Note - Root nodes are limited in terms of the types, quantities and combinations of sub-fixtures that can be connected to their outputs. These constraints are enforced when adding sub-fixtures to root nodes. See the fixture manufacturer's documentation for more information.

The Edit Topology tool can be used to modify the connections between root nodes and/or sub-fixtures after they have been added.

If fixtures are placed on the canvas and physically connected to the processor, use the Add Fixtures from Network tool to associate strings of root nodes in the same way as strings of normal fixtures. When a root node is associated, its outputs are automatically assigned with the correct types of sub-fixtures.

It is not normally necessary to individually associate sub-fixtures. If a sub-fixture doesn't appear associated, the root node can be disassociated by right-clicking and selecting Disassociate.

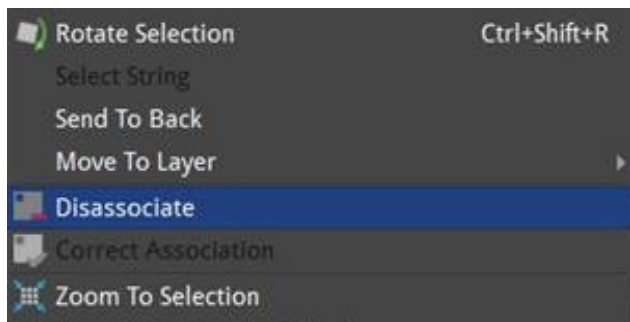

Figure 7-26. Context menu to disassociate a fixture

To re-associate the root-node, right click and select Correct Association to automatically correct the topology for the root node and all connected sub-fixtures.

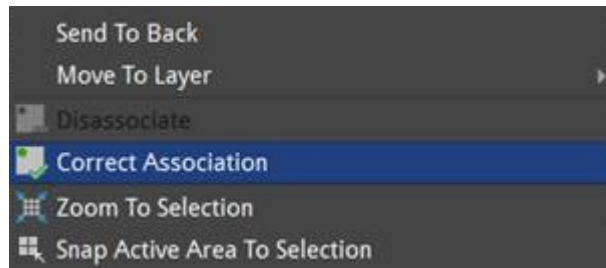

Figure 7-27. Context menu to correct association once a fixture on canvas is discovered

SUB-FIXTURE INTERNAL TEST PATTERNS

Test patterns can be enabled on sub-fixtures from the fixture properties editor. Different patterns can be enabled on each sub-fixture. If test patterns are enabled on one sub-fixture, all other sub-fixtures on that root node will cease to display live video.

A small subset of internal test patterns can also be enabled on root nodes. All sub-fixtures connected to the root node, including one's not currently configured/associated to sub-fixtures are illuminated.

UNDERSTANDING TOPOLOGY AND ASSOCIATION

Tessera processors can detect the topology of connected fixtures. Topology is the order which fixtures are connected, which port on the processor they are connected to and if fixtures are broken into strings by switches. The topology tools are used to help users associate physical fixtures with fixtures on the canvas.

Fixtures are identified by a unique MAC address. When a physical fixture is associated in the project, the MAC address is recorded, and association persists until the user makes changes.

If the real-world topology is changed after fixtures are associated, For example; a video wall is re-cabled, the fixture association is not automatically re-configured by the processor. Turn on Show Topology Errors in Canvas Properties (right-click on canvas) or in the View dropdown menu to highlight in red any changes found on the canvas.



Figure 7-28. Example of incorrect topology, notice the arrows on the far left and right are highlighted in red

SWAPPING FIXTURES AND CORRECTING ASSOCIATION

Each fixture connected to a Tessera processor is recognised as a unique fixture. Each unique fixture is associated with a position on the canvas. If a fixture goes offline or is removed, the fixture remains on the canvas but is now disassociated. The status indicator on the Add fixtures from network button only turns grey when fixtures are offline.

In instances where a fixture is swapped out from the string, the processor will detect a disappearance and a new fixture will appear in the same position. The processor will detect a swap-out has taken place and will offer the user the option to perform Correct Association.

TO PERFORM A SWAP-OUT OF ONE FIXTURE:

1. Disconnect and remove the fixture.
2. Insert and connect a new fixture into the same position of the string. The processor prompts the user with the following message:



Figure 7-29. The correct association dialog box

3. This message is available for 10 seconds. After this message expires, the Correct Association option can be found by right-clicking on the icon of the affected fixture or by selecting Correct Association from the Edit dropdown menu or edit topology toolbar .

CHANGING PHYSICAL TOPOLOGY

If the fixtures' topology is modified, for example to balance the ports load, the fixtures are automatically re-associated.

Example: The fixtures in a wall are associated to the processor in a topology using ports 1 and 2 as shown below:

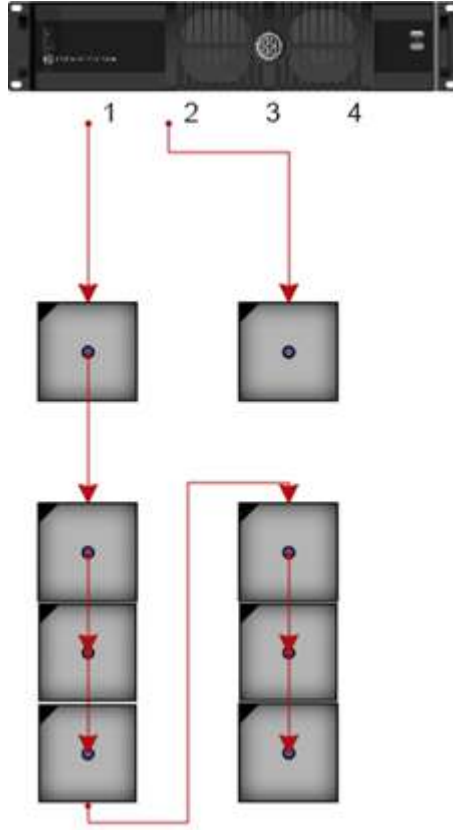

Figure 7-30. Fixtures associated to the processor using ports 1 and 2

Due to the port capacity restrictions, the topology of some fixtures need to be changed from port 1 to port 2 to balance the load on ports.

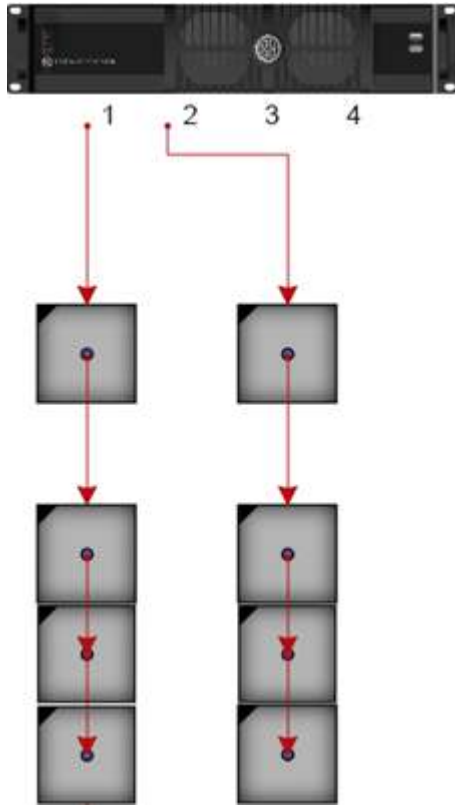

Figure 7-31. Fixtures with topology changed to balance load on ports

The processor automatically recognizes the fixtures MAC addresses and re-associates this fixture in the project. To see the topology errors, enable Show Topology Errors in the canvas view. The fixtures automatically begin functioning at this stage.

The processor may prompt the following message:

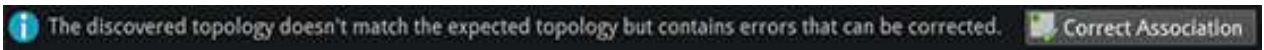

Figure 7-32. The correct association dialog box

Confirm by pressing the Correct Association button .

The Correct Association option can be also done by selecting Correct Association from the Edit dropdown menu or in the Edit topology toolbar menu .

Pressing the correct association button repairs the canvas topology.

CHANGING CANVAS TOPOLOGY

The topology can be manually changed using the topology toolbar that appears when pressing the Edit Topology button.



Figure 7-33. Topology view options

As an example, if the fixtures were first cabled in a continuous string from left to right and from bottom to top as viewed from the front of the screen.

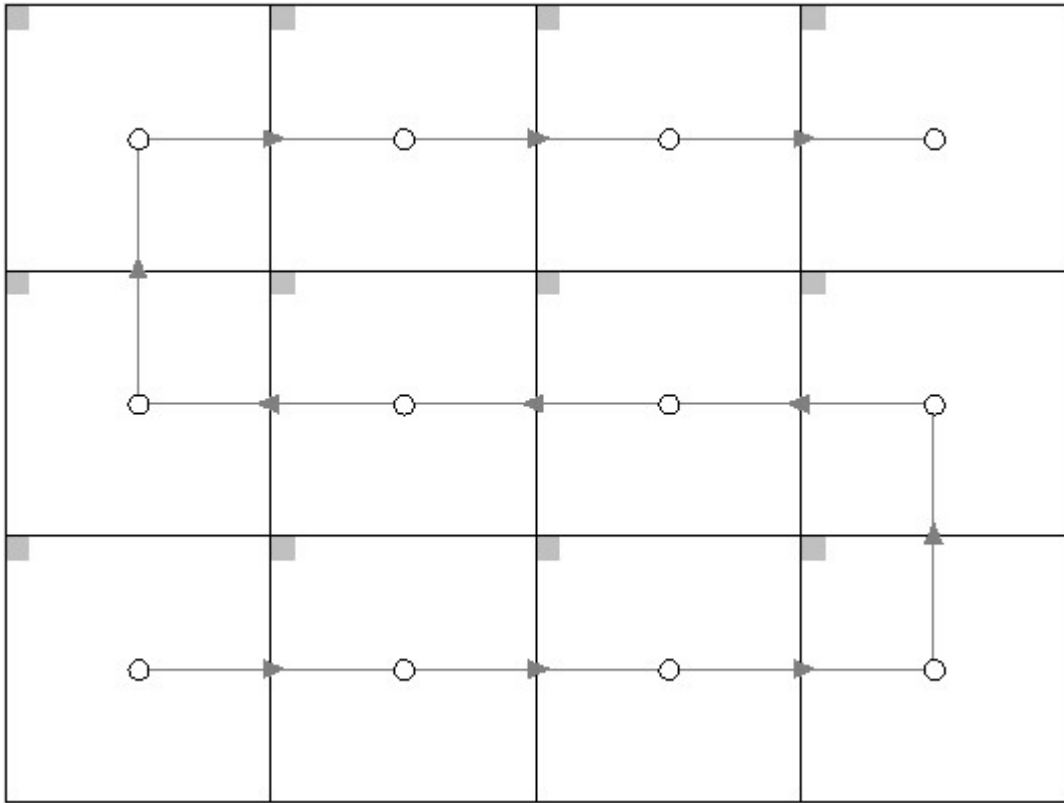

Figure 7-34. First topology

The second time the fixtures are connected, the cabling topology is changed, as shown below.

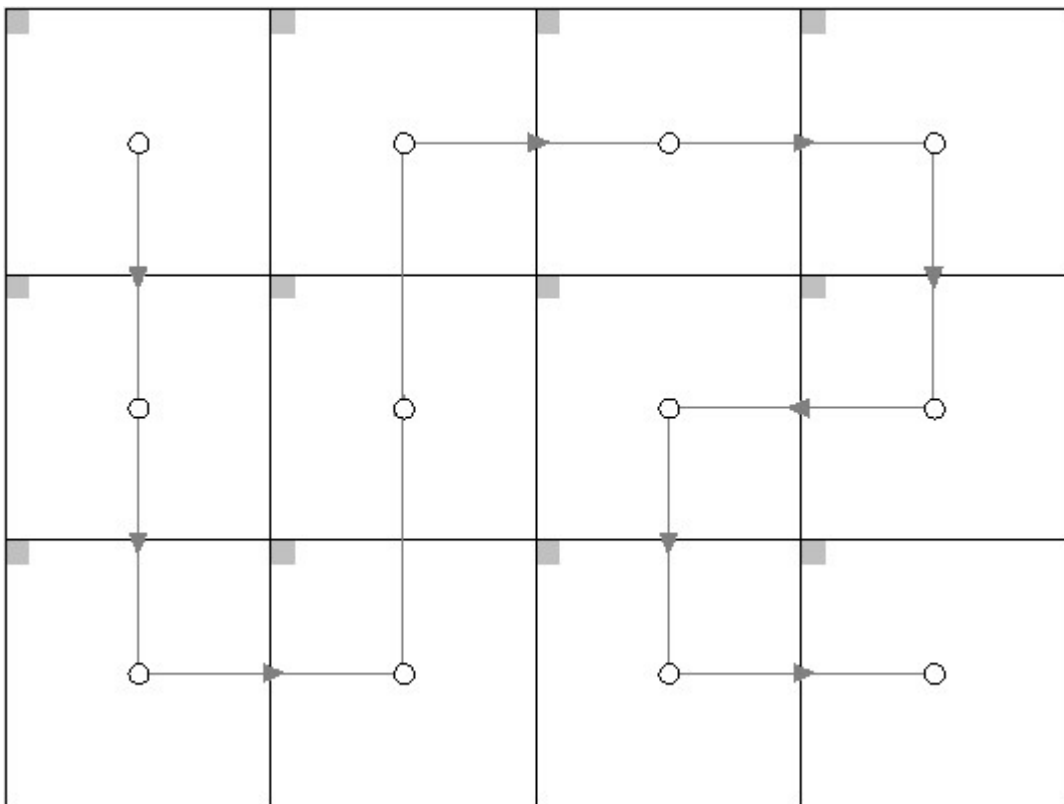

Figure 7-35. Second topology

To correct the screen, use the following steps:

1. On the canvas select all fixtures with the incorrect topology. Right-click the fixtures and select Disassociate.
2. Click Edit Topology to view the Topology toolbar and select the string of fixtures requiring correction by double-clicking on the dot in the centre of a fixture. The whole string is coloured red.

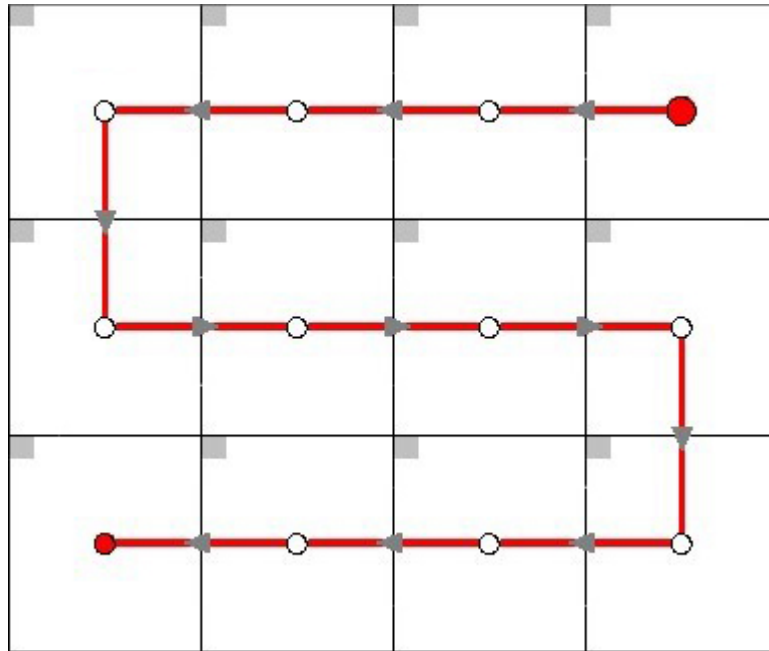

Figure 7-36. The topology is drawn on all fixtures in the string

3. The strike in the Remove Link button changes from grey to red once a string is selected, indicating that it can now be used. Click on it to remove the topology.
4. Hover the mouse over the centre spot of the fixture which is to be at the start of the string. Click and drag the pointer to the centre spot of the second fixture on the string. A dotted red line is drawn which turns solid as the line becomes pinned to the centre spot of the next fixture in the string.
5. Repeat the process until the string is complete.

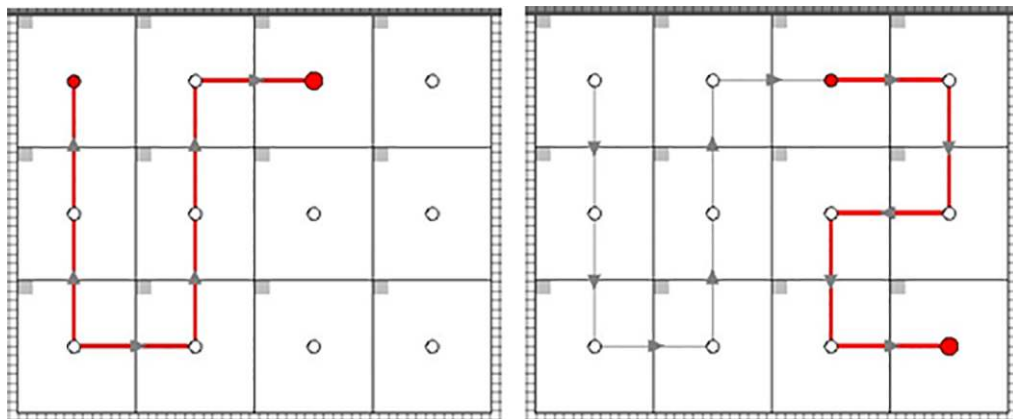

Figure 7-37. Re-applying the string

6. The topology direction can be reversed by clicking Reverse topology  when a string is highlighted.

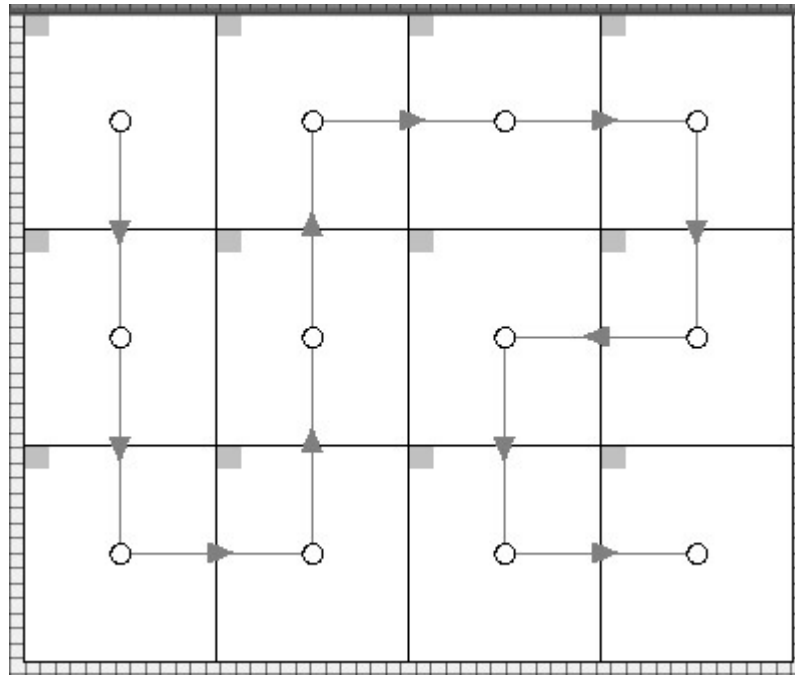

Figure 7-38. Completed topology string

- Once corrections are complete, return to the main project view by pressing Esc or clicking on the arrow located at the top left of the interface. The processor detects a new topology which doesn't match the current association and displays the Correct Association message for 10 seconds.



Figure 7-39. The incorrect topology notification

- Click the Correct Association button to finish the process. The fixture icons display a green indicator when associated to the canvas. Source content can be displayed on associated fixtures.

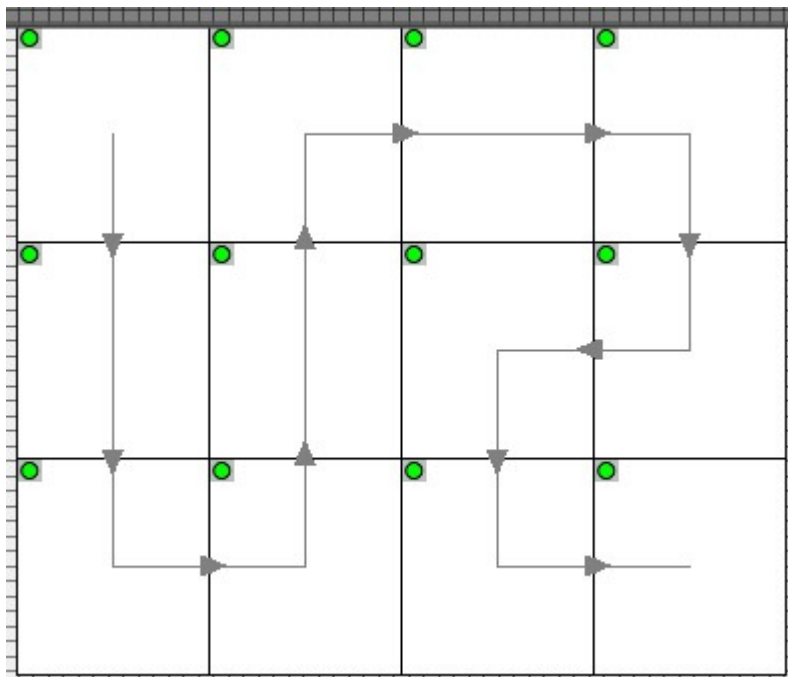

Figure 7-40. The fixtures are online and associated.

Alternatively, the string can be associated using Add Fixtures from Network. See "[Associating fixtures](#)" on page 53 for more information.

FIXTURE LAYOUT

SELECTING INDIVIDUAL FIXTURES

Click to select a fixture. The fixture will turn blue and the Fixture property editor will be displayed on the right side of the user interface. See "[Fixture Properties](#)" on page [46](#) for more information. Right-click on a fixture to display a context menu. See "[Fixture Context Menu](#)" on page [52](#) for more information.

SELECTING MULTIPLE FIXTURES

There are various methods to select multiple fixtures:

- Ctrl + left-click on fixtures to individually select them.
- Hold the left mouse button and drag to create a selection box around the fixtures, release button to finish selecting. For more information about selection modes, see "[Selection Mode](#)" on page [166](#) for more information.
- To select all fixtures on the canvas, use Ctrl + A, or ⌘ + A on Mac OSX.

GROUPING FIXTURES

A selection of fixtures can be combined into a group. When changes are made with the group selected, such as moving or adjusting colour, the fixtures contained within the group always change together. This feature saves time by not having to configure fixtures separately and improves accuracy by moving a wall of fixtures making sure that the relative position of the fixtures don't change.

To set a group, select the required fixtures, right-click to show the context menu and choose Group, the same method is used to ungroup fixtures. Use Ctrl+G to group fixtures or Ctrl+Shift+G to ungroup fixtures.

To select one or several fixtures from a group, hold the Shift key while selecting the fixture/fixtures. These fixtures remain in the group while being modified, without breaking the group.

Note - If a group is broken by ungrouping or removing fixtures, all relevant presets where the group has a recorded position will also be updated/deleted accordingly. The following warning is displayed: "Any colour overrides associated with that group will be lost".

GROUP PROPERTIES

The Group property editor appears when a group is selected. It is composed of Group and Colour.

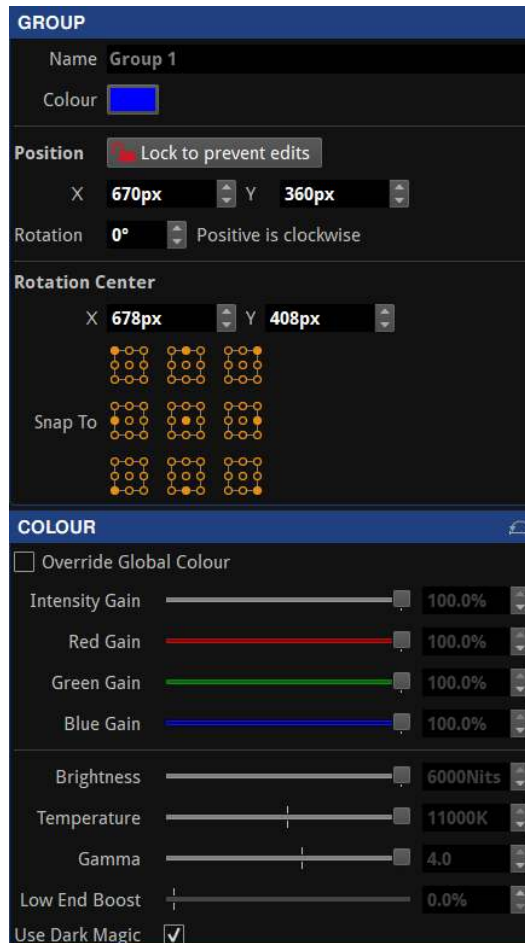

Figure 7-41. Group properties

Group

The group property editor is divided in three sections.

Group info

- Name: Change the name of the group.
- To see the name in the canvas, activate Show Group Names in the View dropdown menu or in the Canvas context menu. See "[Canvas Context Menu](#)" on the page 80 for more information.
- Colour: Click in the colour box to select a different colour from the palette.

Position

The second section of this property editor displays the position and rotation of the fixture in the canvas. Changes can be locked to avoid modifications. Modifications can be made by typing or using the spin box arrows. The Reorient button rotates the fixture by 90 degrees clockwise for square fixtures, or 180 degrees for rectangular fixtures.

Rotation centre

The rotation centre of the group can be modified. The canvas coordinates for the centre can be typed or selected in the spin boxes. Alternatively, choose one of the Snap To options to place it in the predefined positions of the group.

Colour

Colour modifications can be enabled in the selected fixture independently from the Global Colour. When the Override Global Colour box is ticked, colour modifications for the selected fixture are enabled and Global Colour property editor values do not have an effect on the fixture.

GROUP CONTEXT MENU

Right-click in a group to open a context menu with a list of options. Group options are a small selection of the Fixture options. The Select Grouped Fixtures option eases the selection of the fixtures contained in the group instead of the group itself.

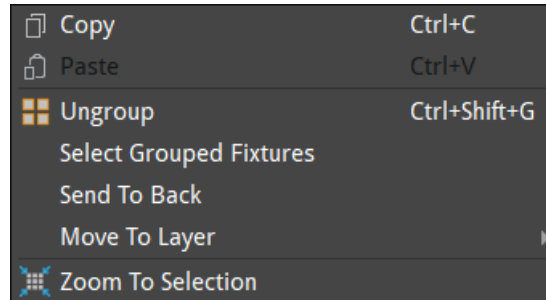

Figure 7-42. Context menu when selecting a group, including an option to ungroup

Select one or several fixtures from a group by pressing the Shift key while selecting the fixture/fixtures. These fixtures remain in the group while being modified, without ungrouping.

MOVING FIXTURES

Fixtures can be moved anywhere on the Canvas, either within or outside of the Active Area by selecting the fixture and dragging with a mouse or pressing arrow keys on the keyboard. Pressing the arrow keys will move the fixture by grid-space increments. The grid space increment size can be modified in the Canvas properties dropdown menu. See "[Canvas Properties](#)" on page [78](#) for more information.

ROTATING FIXTURES

Fixtures can be rotated by 90-degree increments on all processors, however Tessera M2 and T1 LED processors support free rotation, allowing rotation to any degree at a cost of doubling the bandwidth required to drive the fixtures.

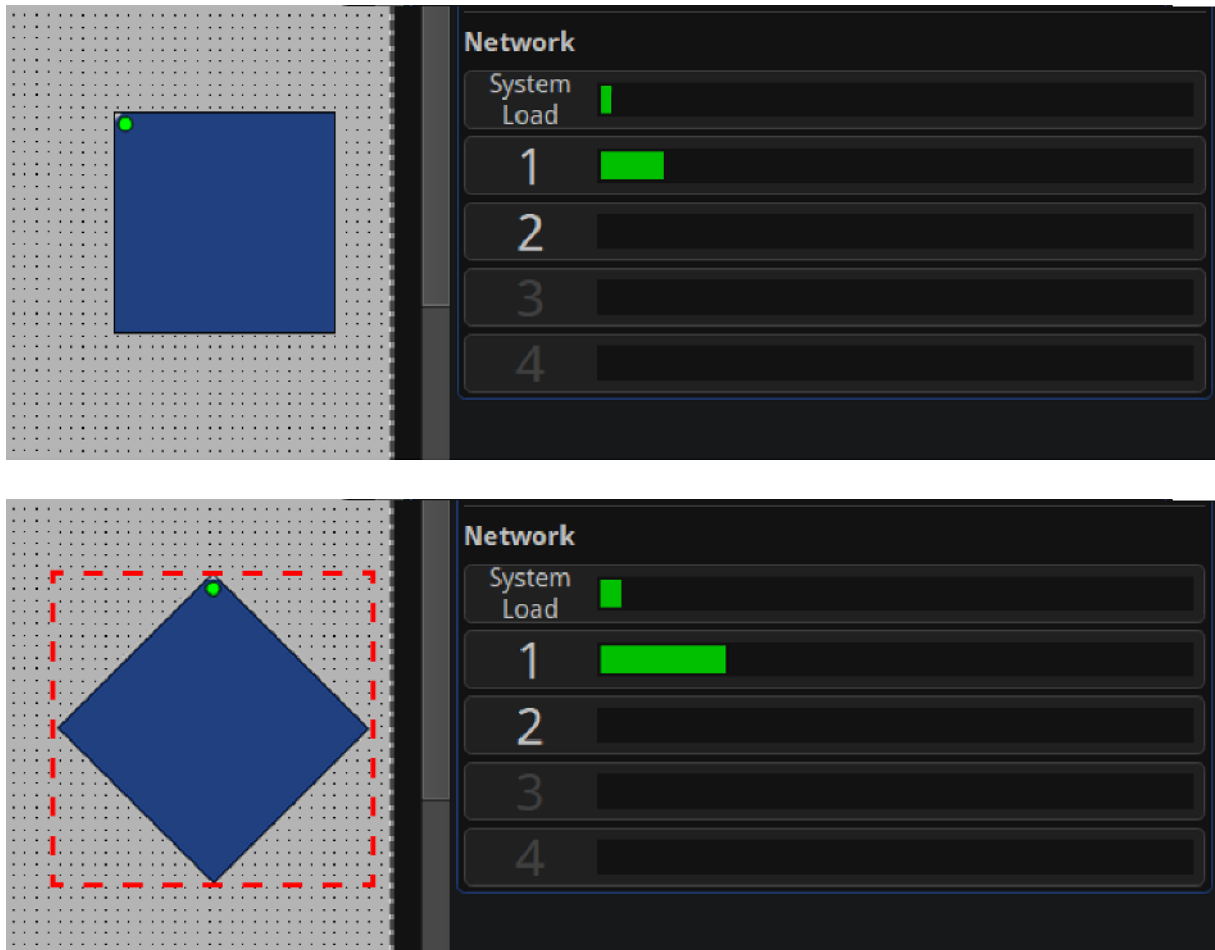



Figure 7-43. Network load is increased when rotating fixtures by 90 degrees

Fixtures can be individually rotated around their top-left corners by first selecting the fixture, then either click the rotation icon in the toolbar  or right-clicking and selecting Rotate Selection. An anchor spot with a handle appears over the fixtures. Both can be dragged to a desired position to change the rotation axis and the rotation angle, respectively.

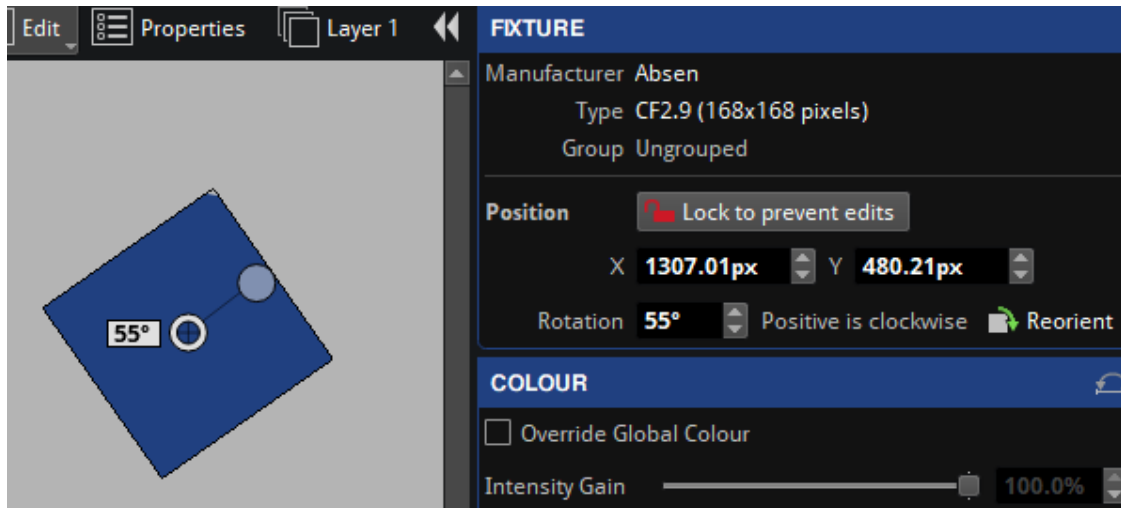

Figure 7-44. Manually rotate a fixture using the anchor handle

Alternatively press Ctrl+Shift+R or select from the Edit property editor to enter rotation mode.

Fixtures can also be rotated during association by pressing the Alt key and using the mouse wheel to change the rotation angle.

Note - The Tessera S4 and SX40 LED processors can only rotate in 90-degree increments.

For further information on how rotating fixtures affects network load see "[Other factors affecting output capacity](#)" on page [27](#).

CHAPTER 8 - MAIN PROJECT SCREEN

When creating a new project, the Main Project Screen opens with multiple view modes:

- Canvas view: Allows layout editing and visualization of fixture position on the selected canvas, topologies, video source and access to the tools for image adjustment in the LED devices, and troubleshooting.
- Topology view (Tessera SX40 only): Provides a representation of the connections between the processors, XD units and fixtures.
- Online view: Provides a list of the fixtures connected and information received by the processor including ports, errors etc.

CANVAS VIEW

The Canvas View gives access to tools for content placement on fixtures, video modifications and adjustment.

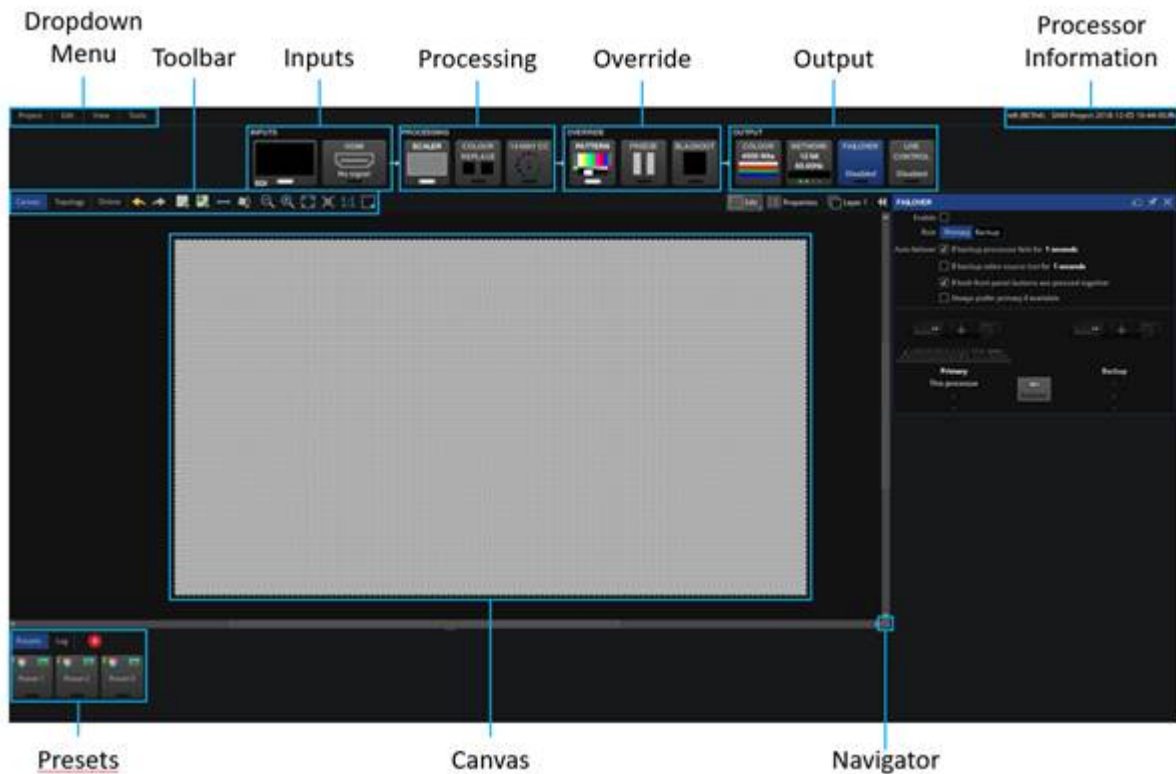

Figure 8-1. Tessera Processor showing Canvas View in detail

CANVAS PROPERTIES

The canvas properties editor can be accessed by selecting Properties in the canvas properties toolbar, on the top-right of the canvas.

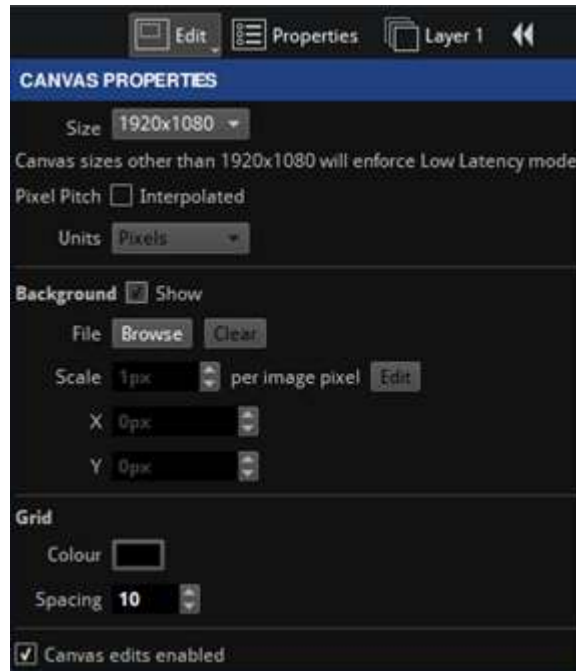

Figure 8-2. Canvas properties

Size

The canvas size can be freely modified however the input source must fit within the width and height dimensions. Depending on the selected resolution, some limitations might apply. See [“Canvas Resolutions”](#) on page 42 for more information.

Pixel Pitch

This option is for Tesseract M2 and T1 processors and only appears when fixtures with two different pixel pitches are drawn in the canvas. Clicking the check-box alternates between 1:1 and interpolated modes. See [“Mapping Options”](#) on page 43 for more information.

Units

Select between millimetres, inches or pixels for the background modifications.

BACKGROUND

Show

Toggle to enable or disable the background view.

File

Click Browse to navigate to a image file from the USB drive or computer (when in Remote mode) to display in the background on the canvas. GIF, JPG or PNG files are compatible.

By default, the image aligns to the top-left of the canvas.

Video snapshot will capture a image of the selected input source and apply it to the canvas background.

Clear

Deletes the assigned background.

Scale

If the image size differs to the canvas size or to the desired size, the size can be modified by selecting a pixel ratio. When the selected units are pixels, a 1 px value will show the real size of the image, values lower than 1 px reduces the image size while values above increase its size.

Press edit to click and drag a line on the background image and specify the final length that it should take in the canvas. The limit of this value is 1000px.

X/Y

Adjust the position of the top-left corner on the background image.

GRID

Colour

If desired, the grid dots colour can be modified. This can be useful when using a background with an identical colour, to be able to differentiate the grid dots.

Spacing

Define the grid space in pixels. This value also modifies the number of pixels that a fixture is moved when using the keyboard arrows to move it around the canvas.

CANVAS EDITS ENABLED

Enables or disables modifying the active area size or position of the canvas. This can be done by clicking the edges of the canvas and dragging to resize it.

See "[Active Area](#)" on page [112](#) for more information.

CANVAS CONTEXT MENU

Right-click an unused area of the canvas to open a context menu with a list of options to customize the appearance and usability of the canvas.

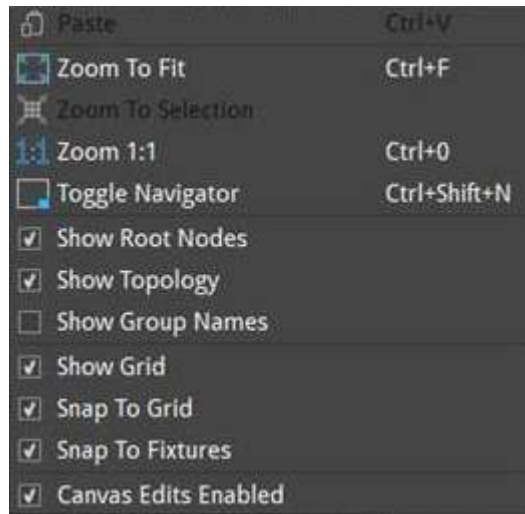

Figure 8-3. Context menu when right-clicking unused area on canvas

Function	Description
Paste	Paste the previously copied fixture to this place on the canvas.
Zoom To Fit	Adjust the zoom and view position to display the complete canvas in the centre of the screen.
Zoom to selection	Adjust the zoom and view position to fit the selected fixtures in the centre of the screen
Zoom 1:1	Adjust the zoom to show the canvas with a 1 to 1 resolution of the display.
Toggle Navigator	Show or hide the navigator window.
Show Root Nodes	Root nodes can be shown or hidden.
Show Topology	Fixture's topology can be shown or hidden.
Show Group Names	Group Names can be shown or hidden.
Show Grid	Grid dots can be shown or hidden at convenience.
Snap to Grid	Pull fixtures into perfect alignment with the grid. Is enabled by default, helping to align or space fixtures evenly on the canvas
Snap to Fixtures	Pull fixtures into perfect alignment with other fixtures. Is enabled by default to align fixtures evenly on the canvas avoiding overlapping or small gaps.

CANVAS TOOLBAR

The Main Toolbar offers a selection of tools to draw fixtures on the canvas and select zoom and view positions.



Figure 8-4. Canvas toolbar features

Icon	Icon Description	Description
	Undo/Redo arrows	Undo and redo the last action performed. The shortcut commands for Undo are Ctrl+Z (⌘ +Z) and Redo with Ctrl+Shift+Z or Ctrl+Y
	Add Fixtures from Library	Access to a menu with all the fixtures included in the fixture packs currently added to the processor. Once connected, these fixtures require associating. See “Adding Fixtures to a Project” on page 53 for more information.
	Add Fixtures from Network	This button does not appear in the offline mode and is greyed out if there are no fixtures connected to the processor. Gives access to a menu for associating physically connected fixtures. See “Adding Fixtures to a Project” on page 53 for more information.
	Edit Topology	Modify and correct the topology connections between fixtures already added.
	Free Rotation of Selected Fixtures	After clicking, an anchor spot with a handle appears over the fixtures. Both can be dragged to a desired position to change the rotation axis and the rotation angle, respectively. See “Rotating Fixtures” on page 75 for more information.
	Zoom In and Zoom Out	To adjust the view of canvas to appear larger or smaller.
	Zoom To Fit	Adjust the zoom and view position to display the full size of the canvas in the centre of the screen.
	Zoom To Selection	Adjust the zoom and view position to fit the selected fixtures in the centre of the screen.
	Zoom 1:1	Adjust the zoom to show the canvas with a 1 to 1 resolution of the display
	Toggle Navigator	Show or hide the navigator window.

CANVAS EDIT VIEWS

EDIT MODE

Edit Mode views allow fixtures to be positioned on the canvas.

Edit Mode:

Keyboard Shortcut: F1

Edit Mode is the default mode for the canvas and allows fixture positioning. In Edit mode the fixtures are displayed as viewed from the front.

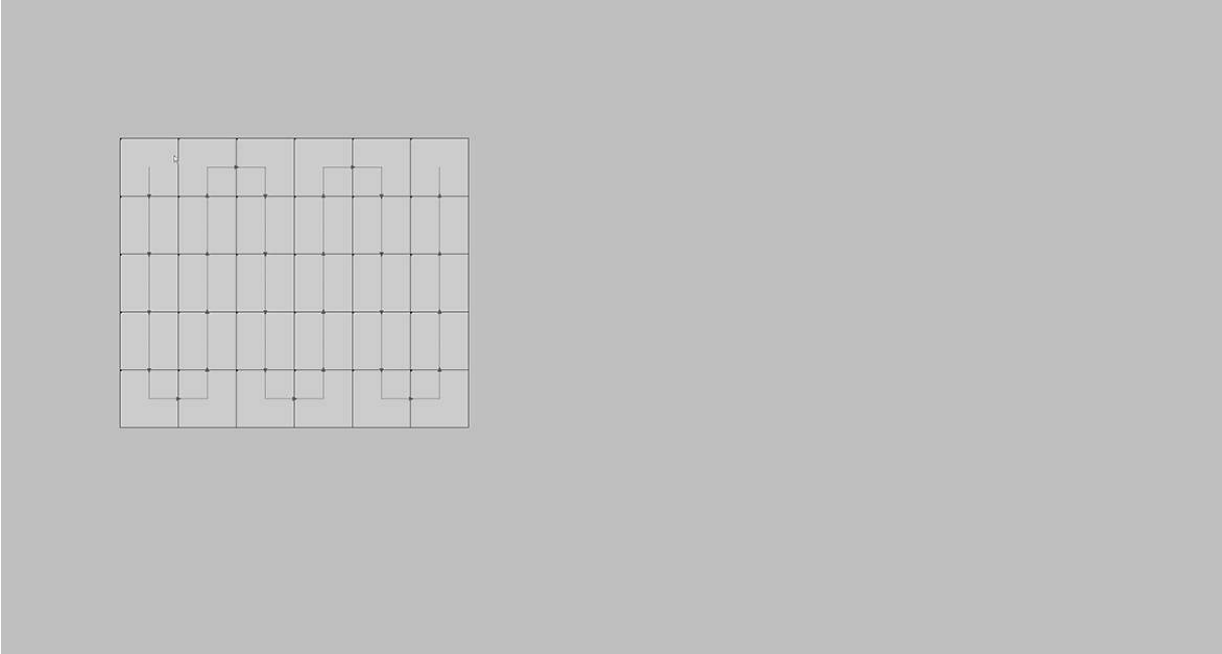

Rear Edit Mode:

Keyboard Shortcut: F2

Fixtures are commonly cabled from behind and Rear Edit allows fixtures on the canvas to be horizontally flipped, as if viewed from behind. This is particularly helpful when you are associating fixtures or troubleshooting from behind the fixtures.

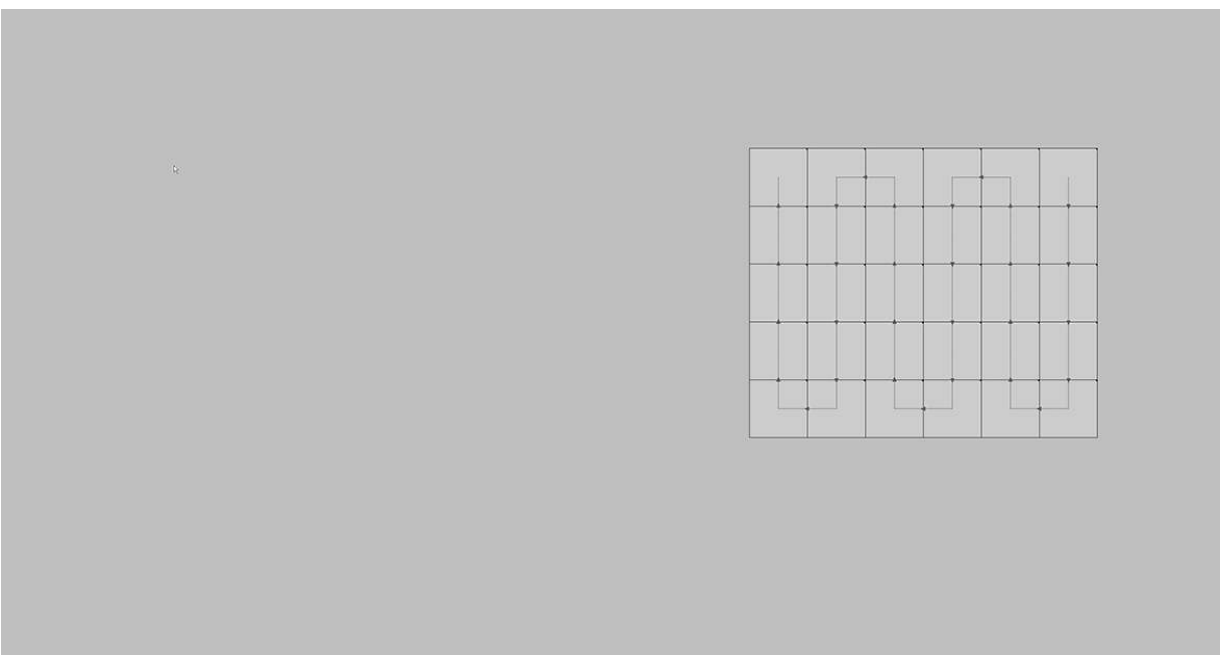

VIDEO ON CANVAS MODE

The Video on Canvas Mode view displays the currently selected video input onto the Canvas, including Viewport and Active Area settings. This mode shows how input content is displayed on fixtures in real-time.

Note - Video on Canvas mode is not available on Tessera S4 processor or accessible using Tessera Remote. Fixtures cannot be moved on the canvas whilst in Video on Canvas Modes.

Fixture Only Mode:

Keyboard Shortcut: F3

Fixture only mode displays the currently selected video input as it is being displayed on the fixtures.



Video And Fixture Mode:

Keyboard Shortcut: F4

Video and Fixture Mode displays the current video input on both the fixtures and the canvas. The video within the Active Area that is not being displayed on the fixtures is shown greyed out as shown in the picture below.

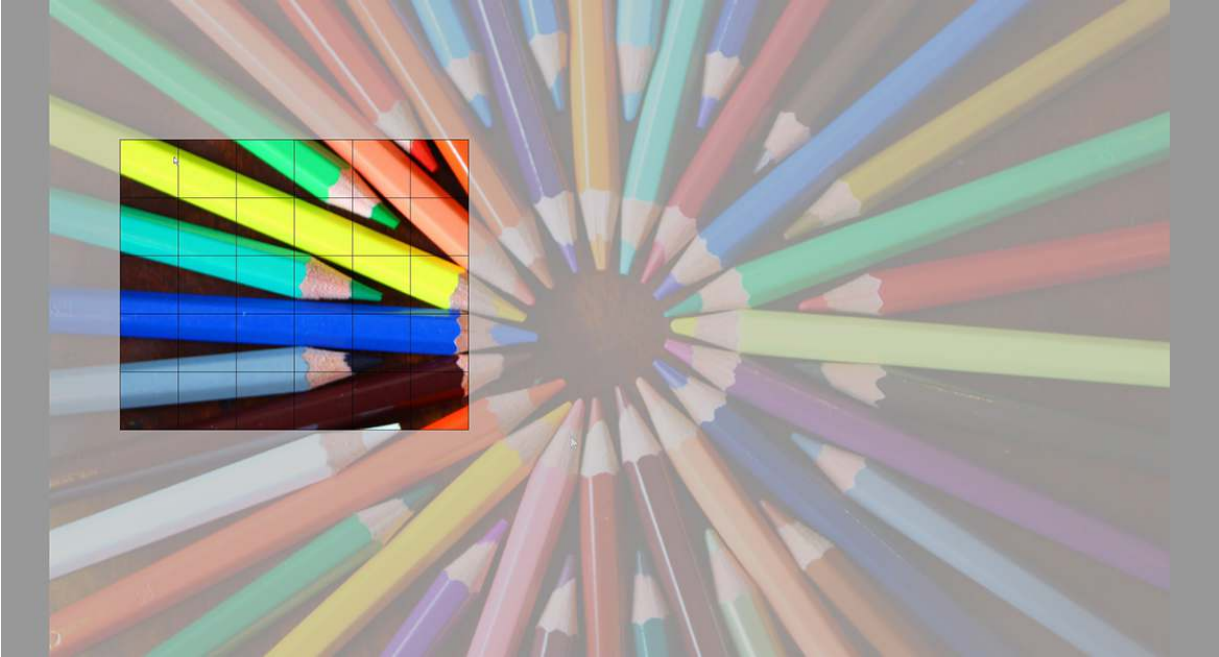

Video Only Mode

Keyboard Shortcut: F5

Video Only Mode displays the current video input within the Active Area on the canvas without displaying the fixtures. This mode is useful to preview the input source size and position in the canvas.



HEAT MAP

Keyboard Shortcut F6

Selecting 'Heat Map' from the canvas display mode button (or pressing F6) displays fixtures on the canvas coloured based on the temperature reported by internal sensors.

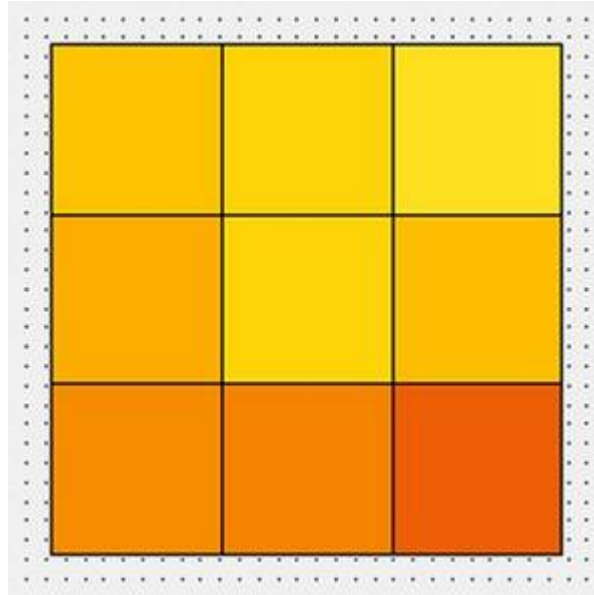

The fixtures display a colour representing the temperature. Temperatures ranging from the coolest fixtures (black) to the hottest fixtures (white). Fixtures that are offline or that haven't reported a temperature are displayed with a grey hatched pattern.



LAYERS

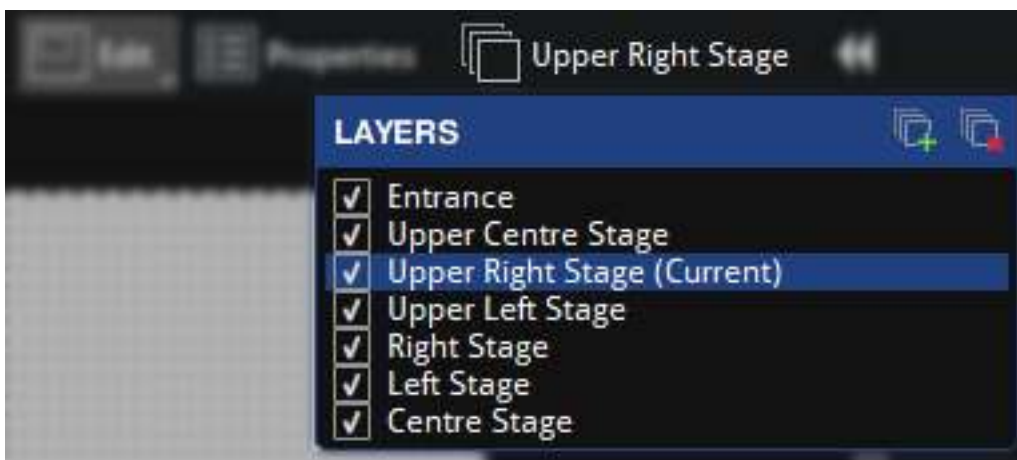



Figure 8-5. The Layers property editor

Layers are an easy way of managing overlapping fixtures.

Fixtures can be assigned to layers which have a Z-order. Z-order refers to the front to back ordering.

Layers are particularly useful when two groups of fixtures are superimposed on the canvas, so that the content can be easily duplicated on two sets of fixtures, such as when using two screens showing the same content on either side of the stage. Layers make it easier and more accurate to select between the two groups of fixtures when making OSCA or other fixture-based adjustments.

Toggling the tick box of a layer shows or hides the layer without affecting the output. Clicking and dragging a highlighted layer up or down allows the Z-order of the layer to be adjusted.

Layers can be assigned or adjusted at any point within the Canvas view. On the right-side of the toolbar, there is a drop-down menu containing layers created for the current project. This menu contains options to add layers , remove layers , drag to prioritise layers and toggle visibility of layers.

Rename a layer by double-clicking the layer name in the layers dropdown menu.

To assign fixtures to layers, select the fixture and right-click. Under Move to Layer, select the layer to use.

PROPERTIES AREA

When working in canvas mode, the Properties area is located on the right side of the screen. It can be shown or hidden by clicking the double-arrow button  placed next to the canvas properties toolbar.

Fixture information, canvas and/or pipeline tiles is displayed in this area.

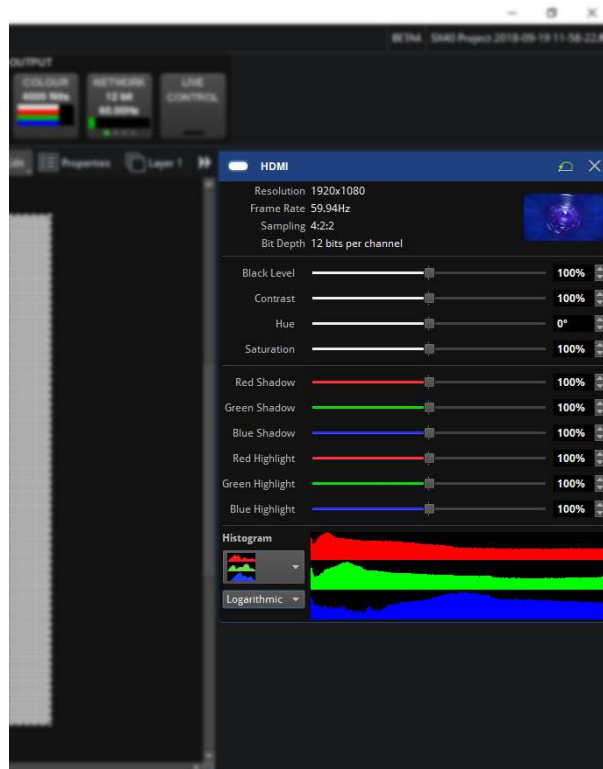



Figure 8-6. The properties area is on the right side of the canvas

When selecting pipeline tiles, a fixture, a group or a combination of fixtures and/or groups, a property editor with information and properties is shown in the Properties area.

WORKING WITH PROPERTY EDITORS

Activate A Feature

Pipeline tile functions can be activated and deactivated by double-clicking on a pipeline tile or Enable button,  next to the name.

Stack Property Editor Widgets

A selection of property editor widgets can be arranged to be displayed simultaneously. Press and hold the CTRL button while clicking in the desired Pipeline tiles to see how the Property editors get added on the Properties area.

A fixture or group property editor can also be selected.

Note - The property editor for a selection of groups/fixtures only displays common settings. The positions, rotation and colour modifications are applied to all selected objects.

Pin Property Editor Widgets To Properties Area

To pin and fix a property editor widget to the properties area so it does not disappear when a different object is selected, press the pin button  located on the right side of the editor title bar.

The editor can still be closed by pressing the close button  located on the right side of the editor title bar.

Close Property Editor Widgets

When a new object such as a pipeline tile, fixture or group is selected, a property editor opens, closing all other Property editors, except those pinned.

Property editors can also be closed by using the close button located on the right side of the editor title bar.

Reset All Values To Default

To reset all the values contained in the Properties editor to default, press the reset button  located on the right side of the editor title bar.

Re-arrange Property Editors

The order of the property editors can be changed by clicking and dragging the property editor title bar and placing it in a different position.

PIPELINE

The pipeline represents the signal flow through the processor. The pipeline is composed of tiles arranged in groups.

Working With Pipeline Tiles

Activating Settings

A white bar on the pipeline tile appears when settings are active. Double-click the pipeline tile to switch settings on or off.



Unselected

Pipeline tile is disabled



Single click

Pipeline tile disabled, property editor shown



Double click

Pipeline tile enabled, property editor not shown unless pinned to property area



Double click

Pipeline tile enabled, property editor shown

Open The Property Editor

Pipeline tile properties can be viewed and adjusted by single clicking on a tile to prompt the property editor to appear.

Note - The selected tiles settings are only activated by double-clicking on the Pipeline tile or toggling the Enable button in the left side of the property editor title bar.

When a property editor is open, the pipeline tile is highlighted in blue.

PRESETS

At the bottom of the Main Project Screen, presets can be set to store settings on the processor. Presets can be made to affect all fixtures, a selection of fixtures or groups. The video source modifications affects all fixtures on the canvas.

Available options to save into presets include:

- Affecting only selected groups or fixtures
 - Fixture or group colour (with override global colour enabled)
 - Group position on the canvas (Only affects groups. The group must be selected during preset recording)
- Affecting all fixtures:
 - Video source selection
 - Video source properties
 - Global Colour
 - Geometry information (Viewport and Active Area)

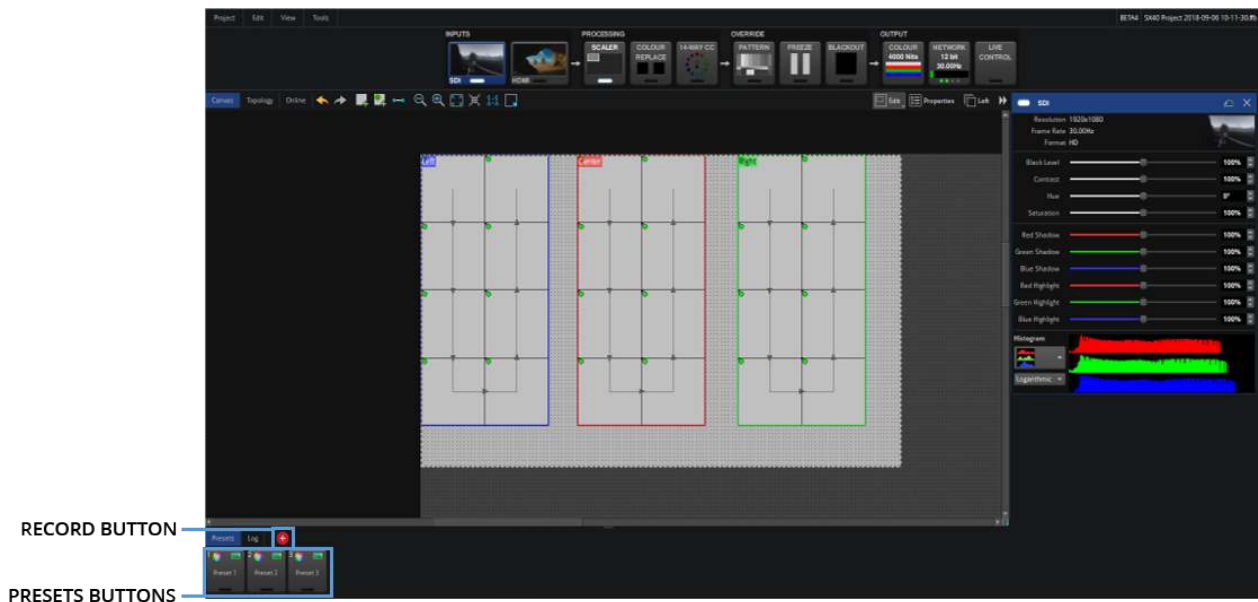

Figure 8-7. Main Project Screen with record buttons highlighted

Presets can be used to set different colour and brightness settings to compensate for changes from day to night or cloudy versus sunny conditions.

USING MASKING

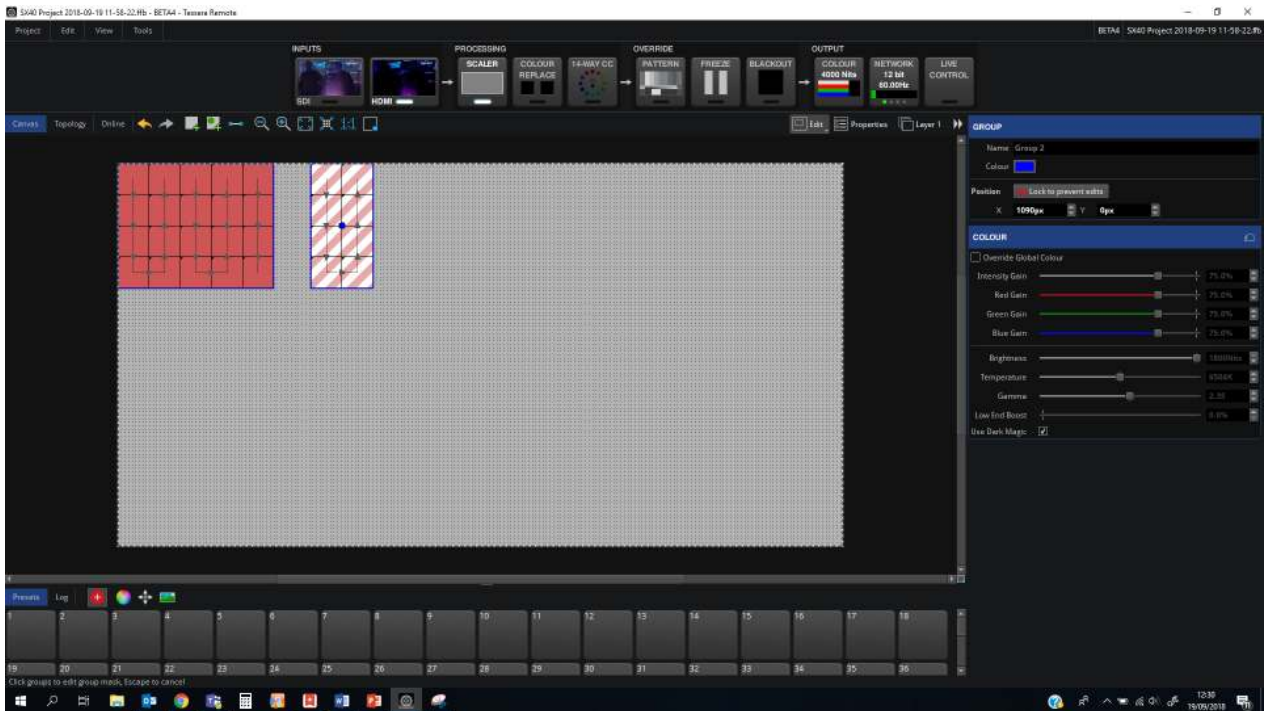

Figure 8-8. Preset Recording view





Masking is useful for security when changing fixture position without altering colour information or to change the input source without affecting the global colour.

When a preset is stored, three icons are displayed. The icons represent information that will be stored within the preset. Colour, position, and video settings can be selected or deselected to include or exclude them from the preset.

RECORDING PRESETS

1. Group the required fixtures and allocate a position on the canvas for the preset to record.

Note - A group can consist of a single fixture.

2. Set the parameters of colour, position or video to store as a preset.
3. Click the red preset record button .
4. Select or deselect the masking controls for colour , position  or video input .
5. The tiles of the available fixture groups appear with striped diagonal lines.

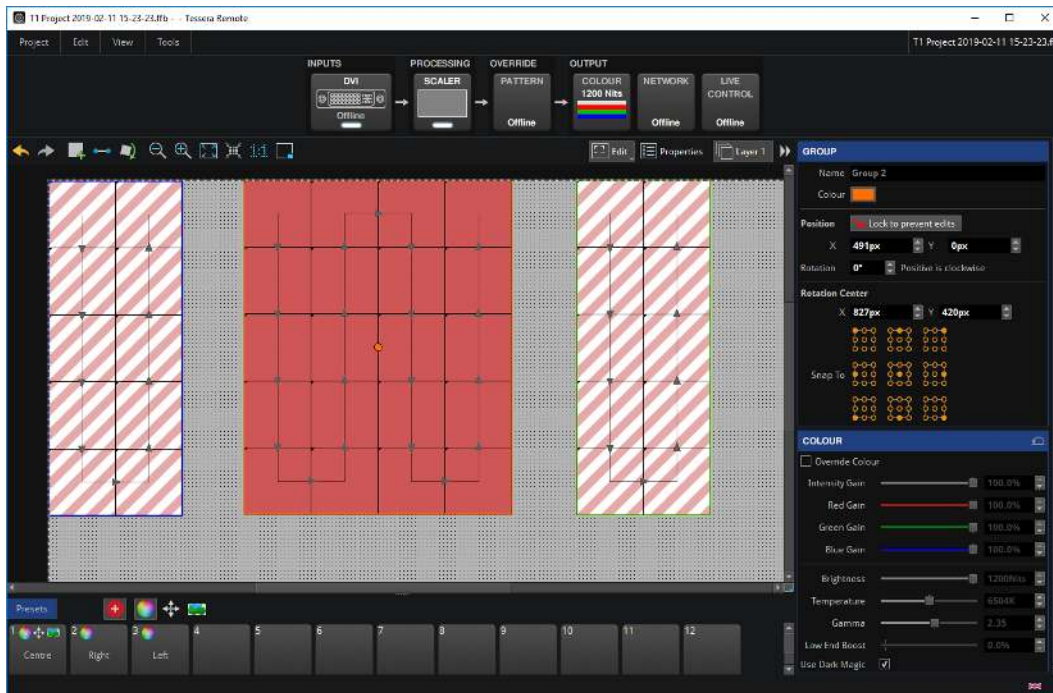

- Only selected groups are stored into a Position preset. Once selected, the diagonal lines on the groups change to solid colour.

If no group is selected, the following warning is shown.

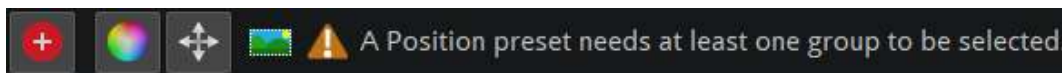

- Click an empty preset tile to store the new preset.
- When double-clicking a preset, the preset recalls settings for associated groups.

EDITING PRESETS

To change any parameters of a stored preset, the preset must be re-recorded. Double-click the stored preset tile, make changes and click the Preset Record button to save.

Right-click on a stored preset tile to rename or delete it.

PRESET PROPERTIES

Click once in a preset to open its property editor.

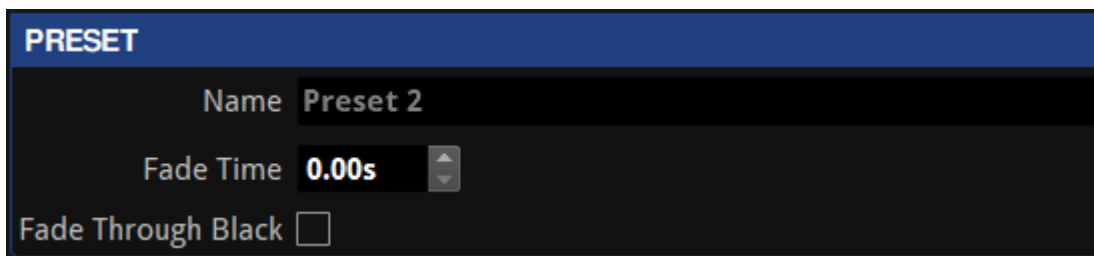

Name	Option to rename the preset tile
Fade Time	Select the cross-fade time
Fade Through Black	Activate to go to black before crossfading to the new source input
Cross-fading	This feature is only available on the Tessera M2 LED processor

Switching inputs can be achieved by creating a Video preset for each input.

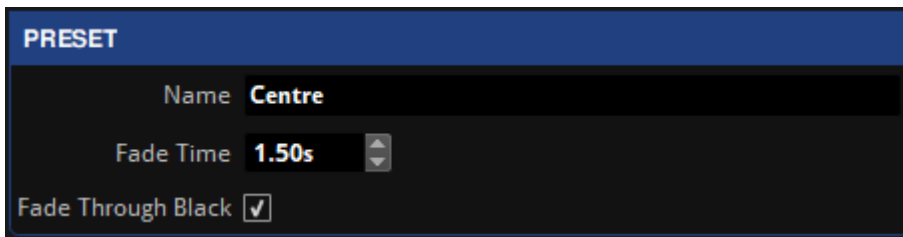

Note - Other values like Colour and Position are not affected by the fade times and are committed as soon as the preset is activated. Crossfade only affects the source selection.

Crossfading between inputs can be achieved by storing the different inputs as presets with a fade time. To store presets to crossfade from one input to another follow these steps:

1. Select the first input for the preset (all tiles are changed to this input).
2. Click the Preset Record button .
3. Select a slot for the preset.
4. Activate a different input by double-clicking on a source pipeline tile (video thumbnail).
5. Repeat steps 2 and 3 to create a new preset for this input.
6. Click on each preset to view properties or set a fade time for the preset.

The presets are ready to crossfade between the inputs.

Note - Note - Tessera M2 LED processor has two input pipelines, each can process up to a 1920x1080 raster at 60Hz. When an input is selected, the input is mapped to the currently unused pipeline then fed into the mixer and scaler functions of the processor. Once any crossfading is complete, the other pipeline is then freed for the next selected input when selected.

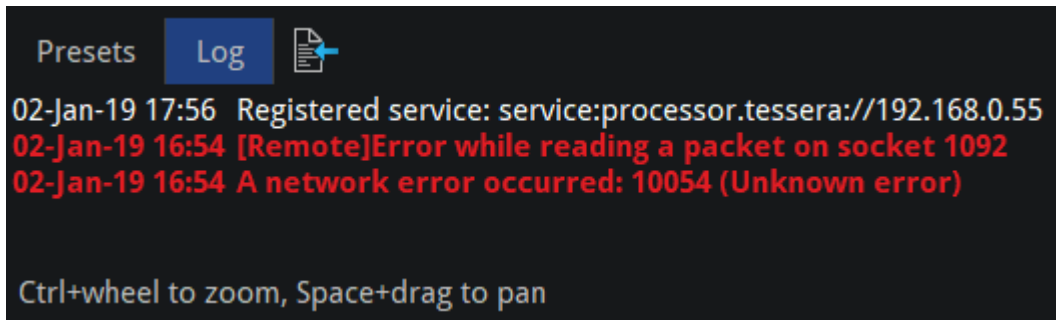

LOG

Information about the processes and errors that occur within the processor can be viewed by clicking on Log.



This information can be stored in a USB drive or on the computer using the button Save the Log .



MOVING AROUND THE CANVAS

Move	Controls
Up, down, left and right	Vertical scrollbar Arrow keys Page up/down keys Mouse wheel Horizontal scrollbar Arrow keys Shift + mouse wheel
Zoom in and out	Use   in the main toolbar Ctrl + mouse wheel Ctrl + + to zoom in, Ctrl + - to zoom out Zoom to fit, Zoom 1:1 or Zoom to selection options
Drag the canvas	Hold the space bar and left-click + drag with the mouse
Modify the active area	Modify the scaler options On the edges of the active area, click and drag as the cursor becomes a double-headed arrow
Move the active area	Modify the scaler options On the top-left of the active area, click and drag as the hand cursor appears

NAVIGATOR

The Navigator provides a simple way of moving around the canvas and adjusting zoom levels. A mini preview of the canvas is displayed, with a red box showing the current visible canvas area. Dragging the box moves the canvas view, and a slider is available for zooming in and out.

Open or close the Navigator window by:

- Clicking the button from the toolbar 
- Clicking the button intersecting the canvas Scrollbars.
- Select Toggle Navigator from the canvas context menu.
- Select Toggle Navigator from the View menu.
- Press Ctrl+Shift+N (or  +Shift+N on Mac)

PROJECT DATA EXPORT

Tessera software has three types of files that can be exported: Canvas image, device layout and discovered devices.

EXPORT CANVAS IMAGE

To export an image, navigate to Tools and select Export Canvas Image. Several options are displayed for the user to choose and control how exported images are rendered. After selecting export options, the user is prompted to select an export location, either on the local file system when using Tessera Remote or on a USB storage device attached to the processor when using the local user interface.

The exported image in PNG format is a pixel-accurate representation of the canvas and has the same dimensions as the canvas.

Note - If using the exported image for content creation, we recommend using the image as a guide only. This avoids artefacts due to aliasing at the edges of small and rotated fixtures.

EXPORT DEVICE LAYOUT

To export the device layout data as a CSV file, navigate to the Tools dropdown menu and select Export Device Layout. The CSV file contains a row for every fixture on the canvas. To choose the columns, select fields from the left list and press the right arrow to move them to the right list. To individually select multiple fields, Hold Ctrl(⌘ for Mac) and click each field.

After choosing export options, select a storage location, either on the local file system when using Tessera Remote or on a USB storage device attached to the processor when using the local user interface.

Data is exported in Comma-Separated Values (CSV) format, which can be opened with spreadsheet applications such as Microsoft Excel, or a simple text editor.

EXPORT DISCOVERED DEVICES

Export discovered devices, exports information identical to the Online view therefore selected filter options, column hiding, and sorting also applies to the exported data. By default this includes:

- Port
- Type
- Serial Number
- Firmware
- Progress
- Port 1 Status
- Port 2 Status
- Temperature
- Orientation
- Status
- Authentication

Navigate to the Tools dropdown menu and select Export Discovered Devices or from Online view and selecting Export Discovered Panels.

Data is exported in Comma-Separated Values (CSV) format. The exported data can be opened and manipulated in spreadsheet applications such as Microsoft Excel, or in simple text editors.

ONLINE VIEW

The Online Fixtures view provides comprehensive information about all fixtures currently detected by the processors output ports.

EXPORTING ONLINE FIXTURE DATA

To export information regarding connected fixtures, navigate to either the Tools drop-down menu or the Online view and click the Export Discovered Devices button. *For more information see: [Project Data Export](#) on page 95*

NETWORK ERROR MONITORING

To help track down faulty cables and connectors in a large system, the Online tab shows an error counter for each connected fixture. Error counters start at zero when the fixture is powered-up and may be manually reset to zero by right-clicking.

Firmware	Progress	Port 1 Status	Port 2 Status	Orientation	Temperature	Status	
2.1.1 BETA3 r3		Out (no errors)	In (no errors)		40.4°C	Associated	Authentic
2.1.1 BETA3 r3		Out (no errors)	In (no errors)		40.5°C	Associated	Authentic
2.1.1 BETA3 r3		In (no errors)	Out (no errors)		39.6°C	Associated	Authentic
2.1.1 BETA3 r3		In (no errors)	Out (no errors)		39.4°C	Associated	Authentic
2.1.1 BETA3 r3		Out (no errors)	In (no errors)		42.0°C	Associated	Authentic
2.1.1 BETA3 r3		In (no errors)	In (no errors)		35°C	Associated	Authentic
2.1.1 BETA3 r3		No link (no errors)	No link (no errors)		41°C	Associated	Authentic
2.1.1 BETA3 r3		Out (no errors)	In (no errors)		38.8°C	Associated	Authentic
2.1.1 BETA3 r3		In (no errors)	Out (no errors)		40.5°C	Associated	Authentic

Figure 8-9. Resetting Network Errors

Fixtures must be running V1.5.0 or later firmware and must be associated (i.e. added to the canvas) for the processor to read the error counts.

Errors do not propagate through the system, which helps to quickly locate a faulty cable. For example:

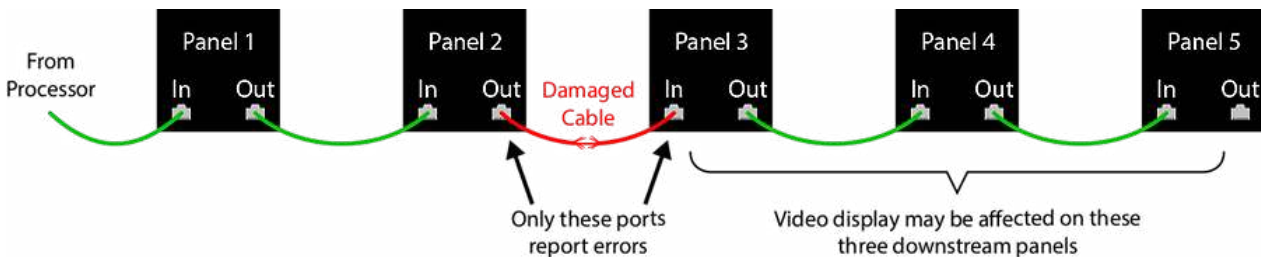

Figure 8-10. Using Network Errors to locate a faulty cable

The error counter values are not reset by events such as the link going up or down, or the fixture being disconnected and reconnected. This is useful for long-term tests as an unexpected disconnection does not increase the error count.

A small number of receive errors can be expected when hot-plugging data cables or power cycling fixtures or processor. This is normal behaviour and does not indicate a fault. At other times, any error count increase indicates a potential fault that should be investigated.

Error counters update every couple of seconds, which helps to correlate errors with intermittent external events that might cause data corruption (such as using radios or the switching of high-power loads nearby). In this case, either remove or relocate the source of the interference, or consider using shielded data cables.

Note - Standard precautions must be taken if using shielded cables, as this can electrically connect the two device's earthing. Ensure both devices are at the same earth potential (especially for the link between the processor and first fixture, as these are often connected to different power sources), otherwise the cable's screen can equalise this voltage, causing a current to flow down the screen, which itself risks corrupting data or damaging the cable or connected devices.

TOPOLOGY VIEW

The Topology View is exclusive to Tessera SX40 LED processors. Topology view shows the current network topology of the processor, connected XD units and fixtures.

On the left, the letters A, B, C, & D represent the physical ports of the Tessera SX40. Green arrows represent a connection between the processor ports to any connected XD distribution units and their ports. The names of the XD units are displayed for recognition.

If fixture chains are connected to any ports, the number of fixtures in the chain is displayed in the topology. Other topologies like daisy-chained XD units and fixtures in closed-loop redundancy are also displayed in this view.

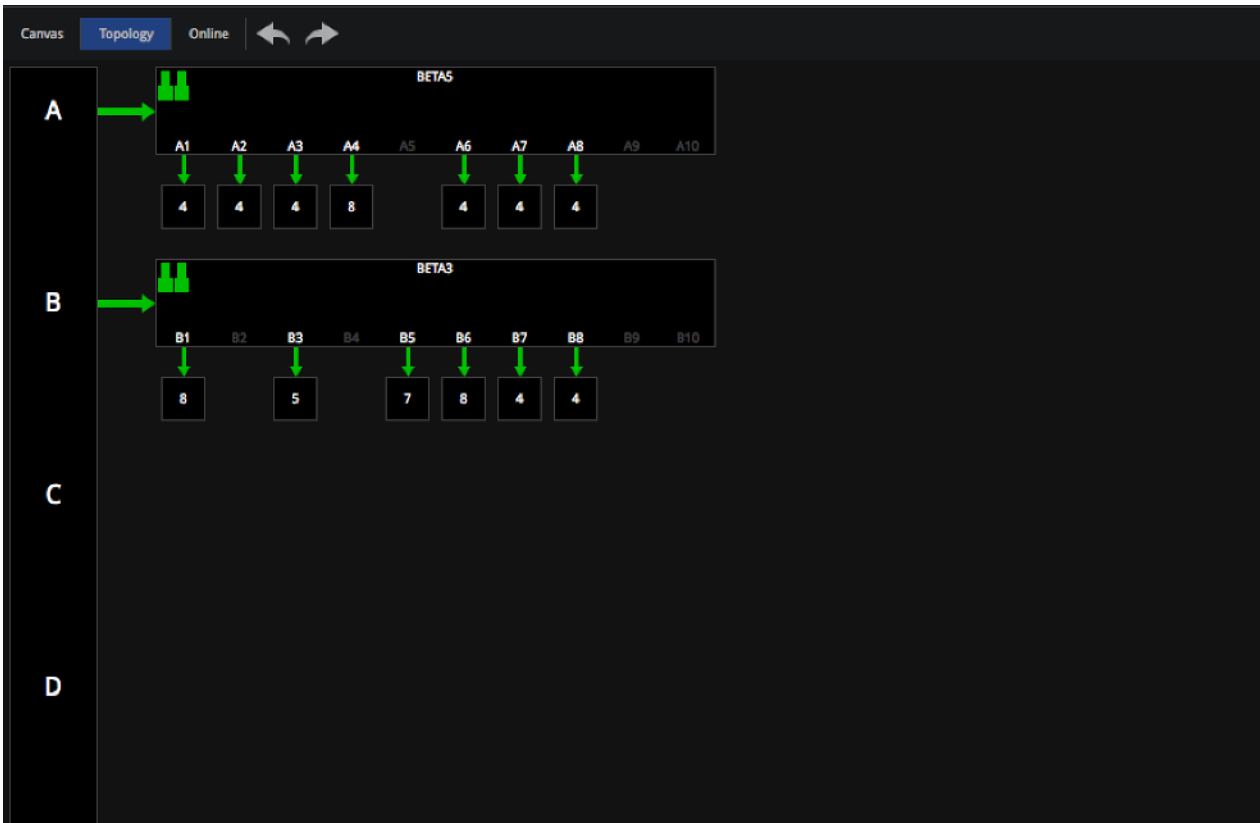

Figure 8-11. Topology View with Fixtures connected to XD units connected to SX40 ports A and B

When working with redundancy, cabling errors are displayed in red port numbers and displays the number of fixtures connected to each port.

Note - Processor redundancy does not appear in the topology view and the offline processor does not show any connections until it is activated on the Failover pipeline tile. See [“Processor redundancy”](#) on page 25 for more information.

CHAPTER 9 - INPUTS

HD SOURCES (FOR M2, T1, S4)

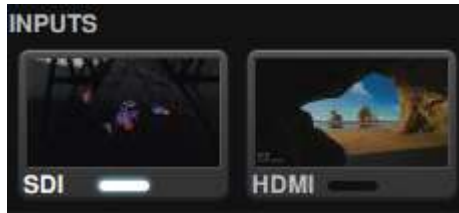

Figure 9-1. Input Sources for Tessera SX40

3G SDI INPUT (M2 ONLY)

Each SDI input on the Tessera M2 LED processor provides support for:

- 3G-SDI Level A
- 3G-SDI Level B Dual-Link (Level B Dual-Stream is not supported)
- HD-SDI
- SD-SDI

Standard broadcast resolutions up to 1920x1080 are supported, with framerates between 23.98Hz to 60Hz and fractional frame rates.

The supported video properties are:

- 10 bits per channel
- YCbCr 4:2:2

The physical connections to the SDI inputs are via standard BNC connectors. In addition to each input there is a thru re-clocked connector that allows for daisy-chaining a signal to a second processor or monitor.

DVI INPUT (M2, T1, S4)

The Tessera HD LED processors support digital (DVI-D) signals up to full HD 1080p resolution at frame rates from 24Hz to 60Hz to a maximum pixel clock of 148.5MHz. The M2 can receive analogue VGA/RGBHV inputs up to full HD (a suitable adaptor for the DVI-I input port is required).

The supported video properties are:

- 8 bits per channel
- RGB
- YCbCr 4:2:2

In addition to the DVI-I input there is also a thru re-clocked DVI-I output.

4K SOURCES (FOR SX40)

12G SDI INPUT

The Tessera SX40 processor provides support for:

- 12G-SDI 2S (SQ is not supported)
- 6G-SDI
- 3G-SDI Level A
- 3G-SDI Level B Dual-Link (Level B Dual-Stream is not supported)
- HD-SDI

Standard broadcast resolutions up to 4096x2160 are supported, with framerates between 23.98Hz to 60Hz and fractional frame rates such as 59.94Hz and 23.98Hz.

The supported video properties are:

- 10 bits per channel
- YCbCr 4:2:2

The physical connections to the SDI inputs are via standard BNC connectors. In addition to each input there is a re-clocked thru connector that allows for daisy-chaining a signal to a second processor or monitor.

HDMI 2.0 INPUT

The Tessera SX40 LED processor supports HDMI 2.0 signals up to 4k DCI with customised resolutions at frame rates from 24Hz to 60Hz with 18Gbps bandwidth to a maximum pixel clock of 600MHz. The Tessera processors do not support HDCP.

The Tessera SX40 can receive DVI-D and DisplayPort inputs (a suitable adaptor is required).

The supported video properties are:

- 8, 10 or 12 bits per channel
- RGB
- YCbCr 4:2:0
- YCbCr 4:2:2
- YCbCr 4:4:4

In addition to the HDMI 2.0 input there is also a re-clocked HDMI 2.0 output.

SOURCE SELECTION

Video inputs can be selected from the user interface when a connection is detected. If more than one source is available, crossfade between sources is also available for the Tessera M2 processor. See [“Preset Properties” on page 91](#) for more information.

Although crossfading from one input to another is available, it is not possible to display multiple inputs simultaneously, in either picture-in-picture or as discrete windows.

While in the canvas screen, the incoming video on each input can be quickly viewed in a thumbnail located in the pipeline tiles.



Figure 9-2. Source preview thumbnails displayed on the pipeline tiles

When selecting an input, its indicator will change from black to white. The quickest way to change inputs is to double-click the input source pipeline tile. Some processors only have a single input, so source selecting is not available.

Any input can be used as a reference signal for Genlock. See "[Genlock Settings](#)" on page [143](#) for more information.

INPUT COLOUR CONTROL

BLACK LEVEL

The black level control affects the base level brightness of the darkest content for the incoming feed. Modifying this value will affect the signal gradually but will be most pronounced at the lower end of the video signal nearest black. For optimum adjustment of the black level, a PLUGE or greyscale line-up pattern can be useful.

Note - What is PLUGE? Picture line-up generation equipment (PLUGE or pluge) is equipment used to generate greyscale test patterns to adjust the black level and contrast of a picture monitor. Images generated from these tools can be saved as bitmaps and these images are sometimes referred to as PLUGE themselves.

CONTRAST

Just as the black level control sets the threshold of the base level of dark content, the contrast slider sets the threshold level of bright content. Boosting this level will increase the differential in luminance between the darkest content and the brightest content.

HUE

The hue parameter adjusts the spectrum of the incoming video feed. At the extreme this will reverse the colours assigned to each area of a given hue.

SATURATION

The saturation parameter adjusts the depth of colour. When reduced the image changes to monochrome with only brightness information intact. Increasing saturation will enhance colour to give a more vibrant image.

RGB SHADOW

This option is for setting the black level specifically for each primary colour for the selected input. These sliders equate to a setting for the black level of each specific colour.

RGB HIGHLIGHT

RGB Highlight is for adjusting the contrast (white level) for each of the primary colours.

HISTOGRAMS

Tessera LED processors offer a selection of histograms to depict distribution of pixels across the possible range of a colour or colours of the incoming video feed in real time after they have been modified by the input colour controls. There are six different histograms available, and all histograms can be displayed linearly or logarithmically:

- Luminance
- Red
- Green
- Blue
- Red, green and blue with separate histograms
- Red, green, blue and luminance with overlaid histograms

The main use of histograms is to identify and compensate for perceived deficiencies in the incoming video feed. The user can monitor how changes to the input colour controls can affect the colour content of that feed. Adjusting the controls can boost the colour depth of the displayed signal, resulting in a better distribution of peaks in the histogram.

The X-Axis of each histogram is graded from 0% to 100%, a column is used to indicate how much content there is at that percentage of the given colour. The Y-Axis shows the amount of content as a percentage, it automatically scales to fill the axis.

The logarithmic scale will accentuate small columns so tiny areas of a colour can be visualized in instances where one percentage dwarfs all others.

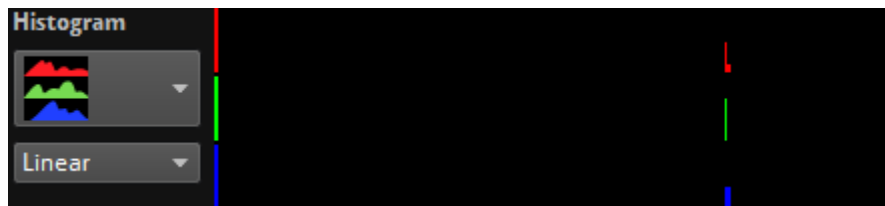

Figure 9-3. Test pattern showing colour bars at 75% and the corresponding Linear RGB histogram

The above picture shows a test pattern and its corresponding Linear RGB histogram. Note that there are clear columns at 75% for each of the three primaries. This is because all colours are either primary colours at 75% (red, green and blue sections) or secondary colours made from combinations of the primaries at 75% (cyan, yellow, magenta and white sections).

There is also a large peak at 0% on the left which shows the amount of black in the image. There is a clear peak on the right which represents an area of 100% RGB and is caused by the single block of 100% white towards the bottom left of the image.

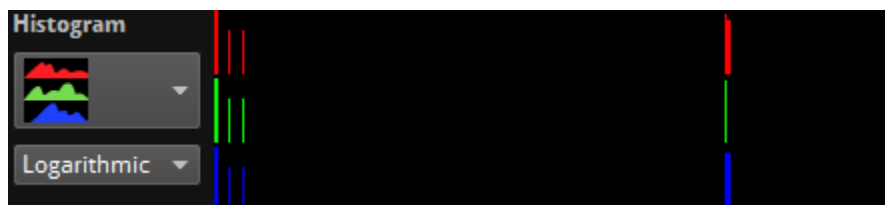

Figure 9-4. Test pattern showing colour bars at 75% and the corresponding Logarithmic RGB histogram

The above picture shows a logarithmic visualization of the input. Although the same three areas 0%, 75% and 100% show the highest concentrations of columns, there are now more areas visible. There are some small amounts of colour which deviate from the three values and the image is not perfectly composed of 75% colour as represented by the linear scale.

The peaks corresponding to the black and white areas of the input image are located at the beginning and end of each histogram indicate that this content source is well balanced, and the full spectrum is being used.

SETTING COLOUR CONTROLS WITH THE AID OF HISTOGRAMS

Histograms are useful for determining if an incoming signal is filling the entire spectrum of colour and brightness.

Note - When choosing an image to balance, use an image from live event content throughout the project, an image with a wide variety of colours and hues, or a suitable test pattern.



Figure 9-5. A fairly washed out incoming signal on DVI (see thumbnail top left) with the corresponding histogram for red, green and blue when the Input



Figure 9-6. Adjusting the black level control will make the blacks look darker and the concentrations of colour now reach down to 0% on the scale



Figure 9-7. Adjusting the contrast control will make brighter areas appear closer to the 100% threshold, assuming some areas contain white content in the image and is desirable

If specific colours do not render correctly, adjust RGB Highlight and Shadow controls to work on that specific colour without affecting the other two primaries. Use the histogram for each colour individually to assist with adjustment.

CHAPTER 10 - PROCESSING



Figure 10-1. Processing pipeline tiles, featuring scaling and Chromatune features, colour replace and 14 way colour correction

SCALING AND CROPPING

The Tessera M2 and T1 LED processors support scaling and cropping of the incoming feed. The Tessera SX40 processor supports scaling. These functions are achieved using two settings: Viewport and Active Area.

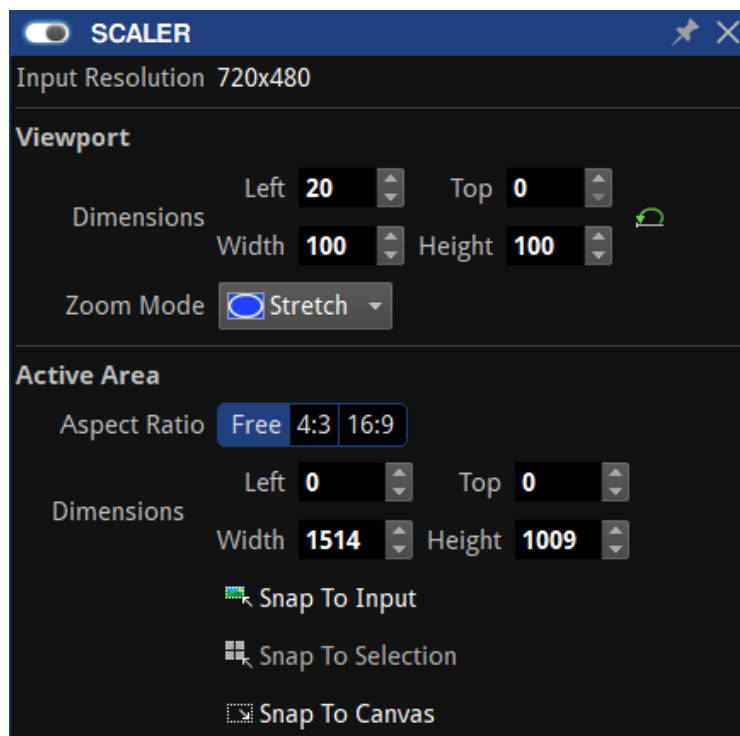

Figure 10-2. Scaler property editor

VIEWPORT

The Viewport settings define the region of interest from the incoming feed which is captured to the canvas. By default, when activating the Scaler pipeline tile, the settings will be set to fit the canvas, with full size viewport and full size Active Area with stretch Zoom mode. The Viewport is scaled and mapped onto the Active Area according to the Zoom mode.

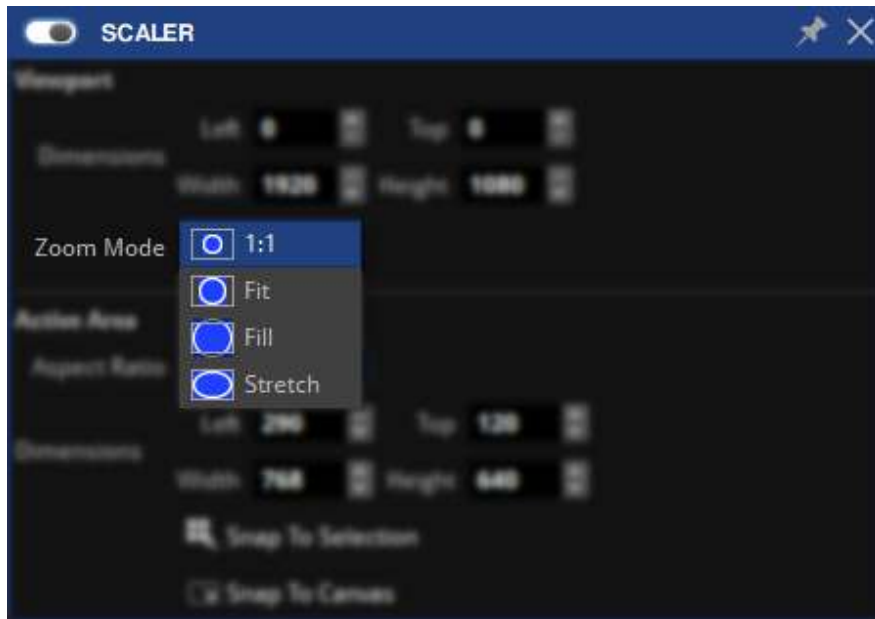

Figure 10-3. Scaler zoom mode options

1:1 MODE

The 1:1 mode selects and crops an area of the input maintaining the original Viewport image size.

Dimensions

- Left: Determine the column of pixels that will appear on the left of the canvas
- Top: Determine the row of pixels that will appear on the top of the canvas
- Width: Determine the total width of the source (Maximum width will be the canvas width minus the Left value)
- Height: Determine the total height of the source (Maximum height will be the canvas height minus the Top value)

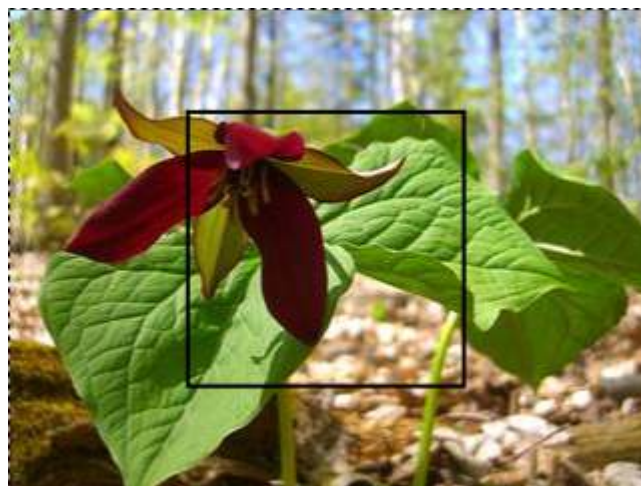

Figure 10-4. Canvas is scaled to 1:1

FIT MODE

The Fit mode selects a section of the input and scales it to fit within the active area while maintaining the aspect ratio.

Dimensions

- Left: Determine the column of pixels that will appear on the left of the canvas
- Top: Determine the row of pixels that will appear on the top of the canvas
- Width: Determine the total width of the source before being stretched (maximum width will be the canvas width minus the Left value)
- Height: Determine the total height of the source before being stretched (maximum height will be the canvas height minus the Top value)



Figure 10-5. Scaled to fit within the active area

FILL MODE

The Fill mode selects a section of the input and scales it to fill the active area while maintaining the aspect ratio.

Dimensions

- Left: Determine the column of pixels that will appear on the left of the canvas
- Top: Determine the row of pixels that will appear on the top of the canvas
- Width: Determine the total width of the source before being stretched (maximum width will be the canvas width minus the Left value)
- Height: Determine the total height of the source before being stretched (maximum height will be the canvas height minus the Top value)



Figure 10-6. Scaled to fill source to active area

STRETCH MODE

The Stretch mode selects a section of the input and stretches it to fill the active area and match its width and height.

Dimensions

- Left: Determine the column of pixels that will appear on the left of the canvas
- Top: Determine the row of pixels that will appear on the top of the canvas
- Width: Determine the total width of the source before being stretched (maximum width will be the canvas width minus the Left value)
- Height: Determine the total height of the source before being stretched (maximum height will be the canvas height minus the Top value)



Figure 10-7. Source is stretched to fit within the active area

ACTIVE AREA

On the canvas, the Active Area is indicated by the grey mask with a dashed border.

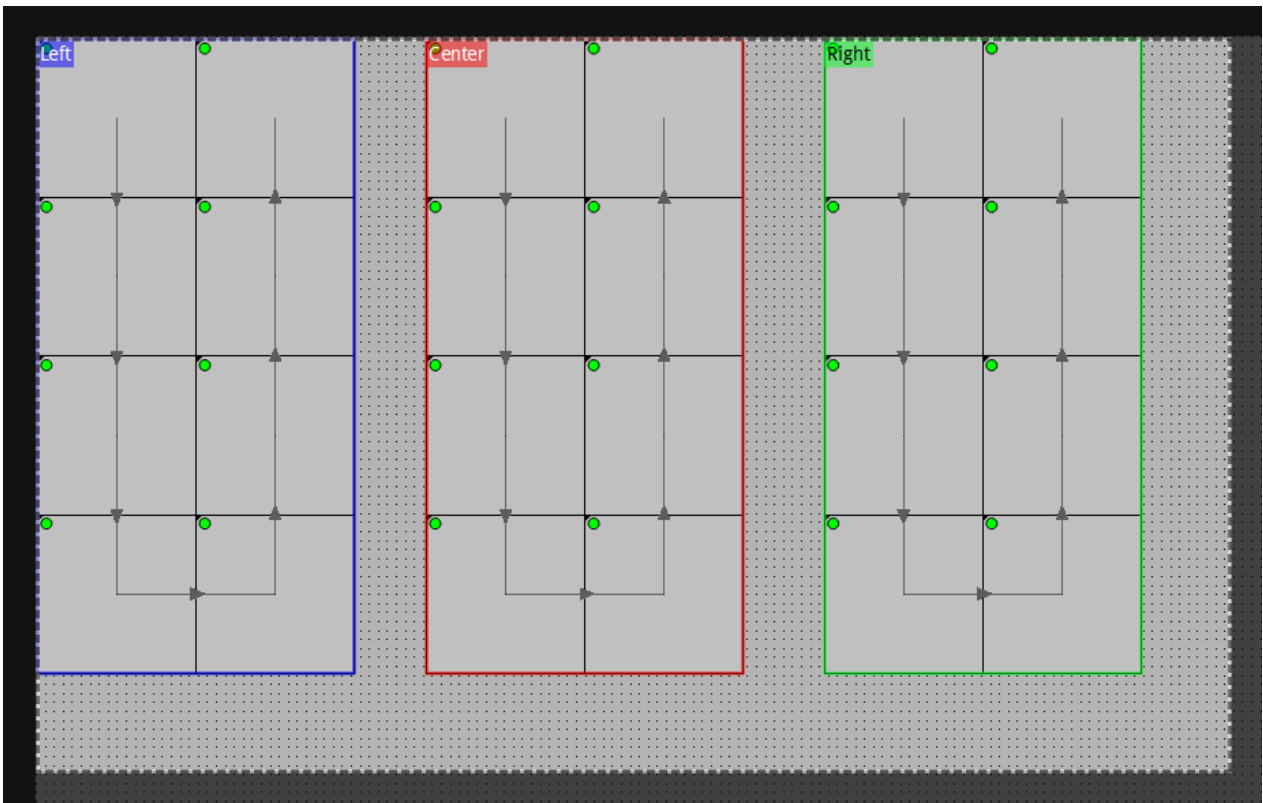

Figure 10-8. The canvas with the Active Area shown by a dashed border

Having determined the region of interest to be captured from the incoming feed using the Viewport, that region can then be sized or moved as desired. Modifying the active area values, will move or scale the area cropped in the viewport.

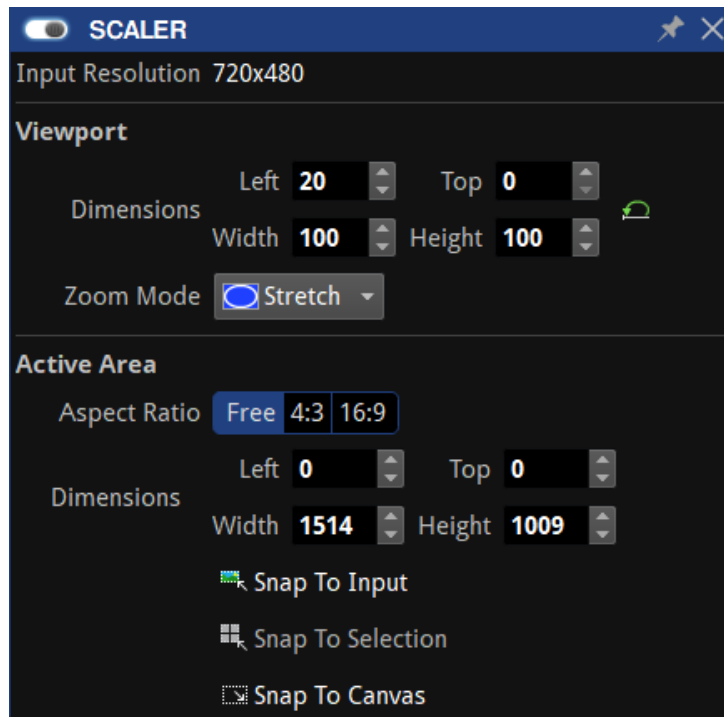

Figure 10-9. Scaler property editor

ASPECT RATIO

The Aspect Ratio value will force the dimensions into a standard ratio (4:3 or 16:9). Select "Free" to allow flexible modifications of the content.

Dimensions

- Left: Determine the position of the left edge of the active area
- Top: Determine the position of the top edge of the active area
- Width: Determine the final width of the active area
- Height: Determine the final height of the active area

To scale the content, set the Active Area dimensions to values greater or smaller than the Viewport. The size of the Active Area can be changed by dragging the dashed line on the canvas or entering values in the Width and Height fields.

Note - The active area cannot be greater than the maximum canvas size.

To modify the active area, move the mouse cursor to the top-left corner of the active area until it becomes a hand , then click and drag the area. Positions can also be determined by adjusting the top and left coordinates manually.

SNAP TO INPUT

Adjust the active area size to match the input source size.

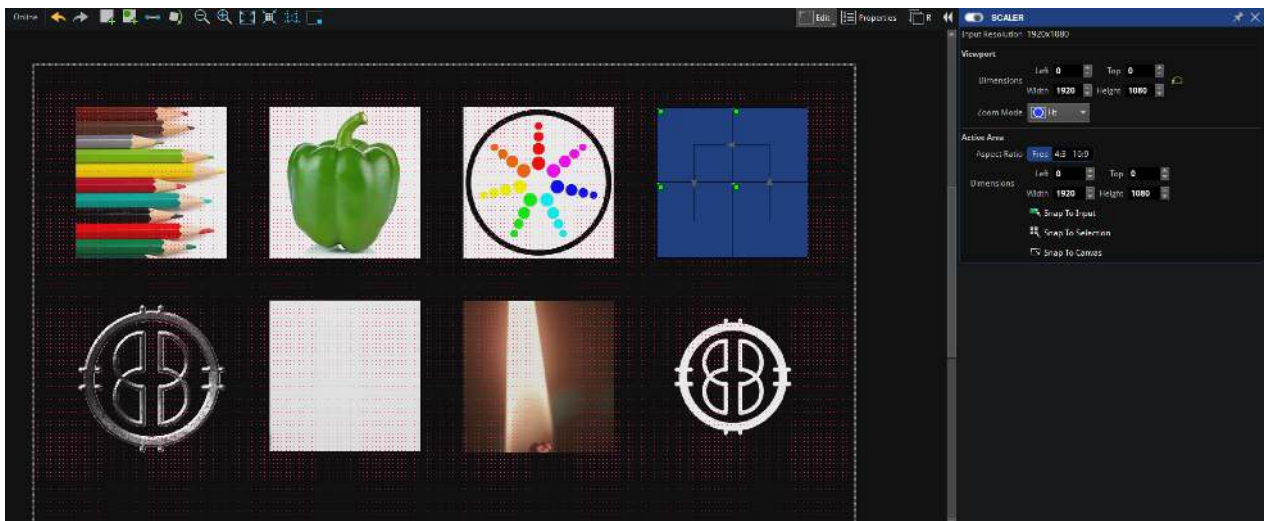

Figure 10-10. Snap to Input

SNAP TO SELECTION

Adjust the active area size to match the size of the selection of fixtures. To resize the input source to fit all visible fixtures, select the chosen fixtures and click the Snap to Selection button.

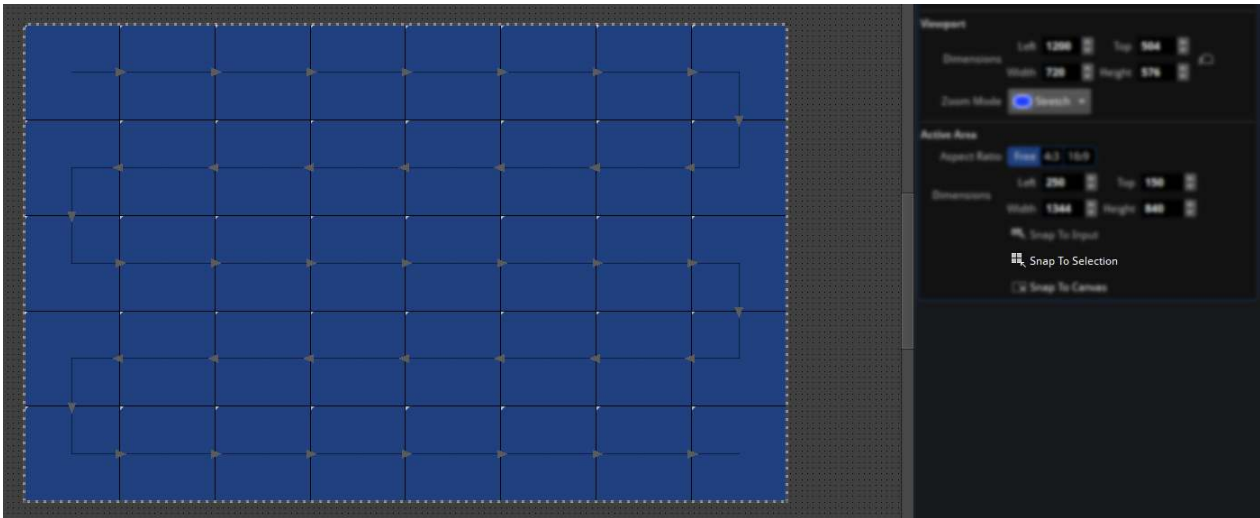

Figure 10-11. Active area scaled to snap to fixture selection

SNAP TO CANVAS

Adjust the active area size to match the canvas size.

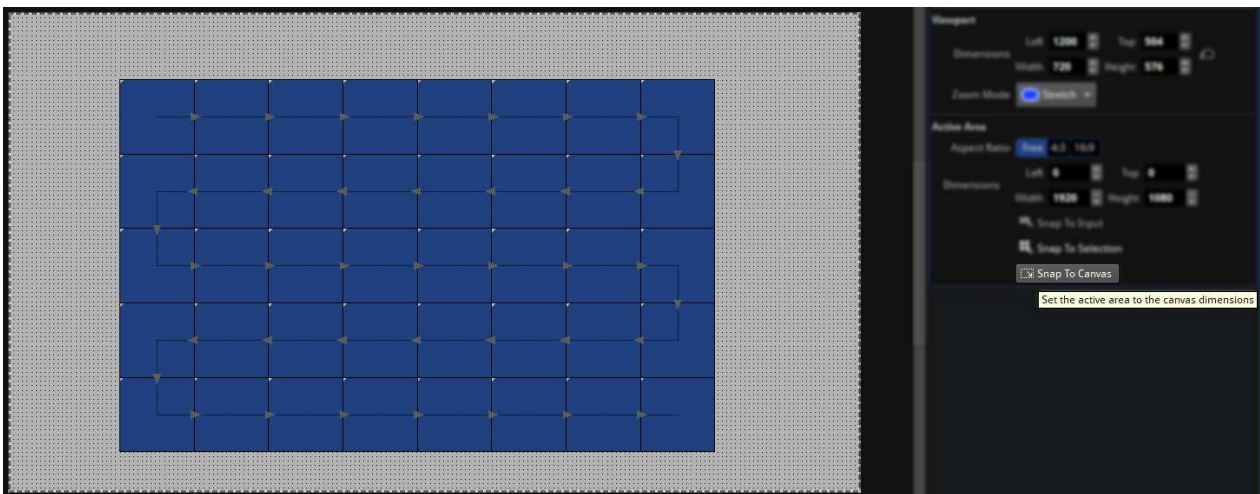

Figure 10-12. The active are is set to the canvas dimensions

CHROMATUNE



Figure 10-13. ChromaTune pipeline tiles, colour replace and 14 way colour correction

ChromaTune consists of two advanced colour correction features. One is Colour Replace, which gives the user advanced control to manipulate one specific colour with flexibility. The other is 14-way Colour Correction which enables adjusting one or a number of pre-defined colours by modifying their Hue, Saturation or Brightness.

COLOUR REPLACE

Colour Replace allows one colour of an incoming source to be replaced by another. The Enable toggle button shown in the top-left activates the effect.

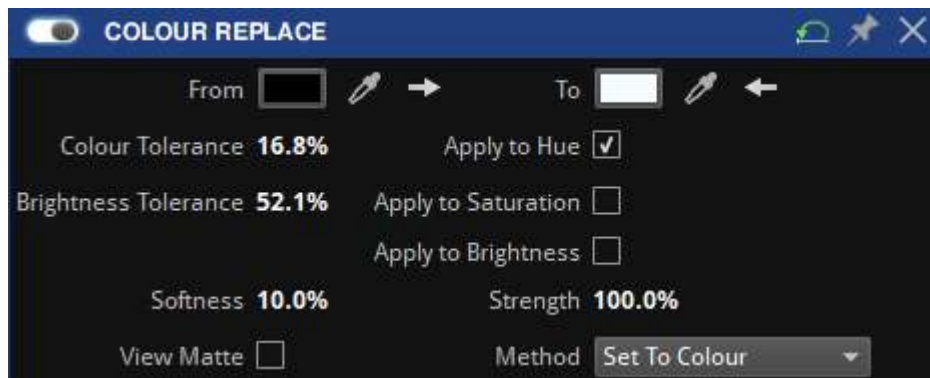





Figure 10-14. Colour Replace property editor

- From: Select the original colour to be modified. Select a colour by clicking on the colour chip, or by clicking the eyedropper  to select a colour from the incoming source on the canvas. The arrows  next to the eyedropper transfer the colour from the respective colour chip to the other colour chip.
- To: Select a colour target to replace the From colour with. The colour can be chosen in the same way as From, by clicking on the colour chip and selecting from the colour picker, or by using the eyedropper tool. The arrows  next to the eyedropper transfer the colour from the respective colour chip to the other colour chip.

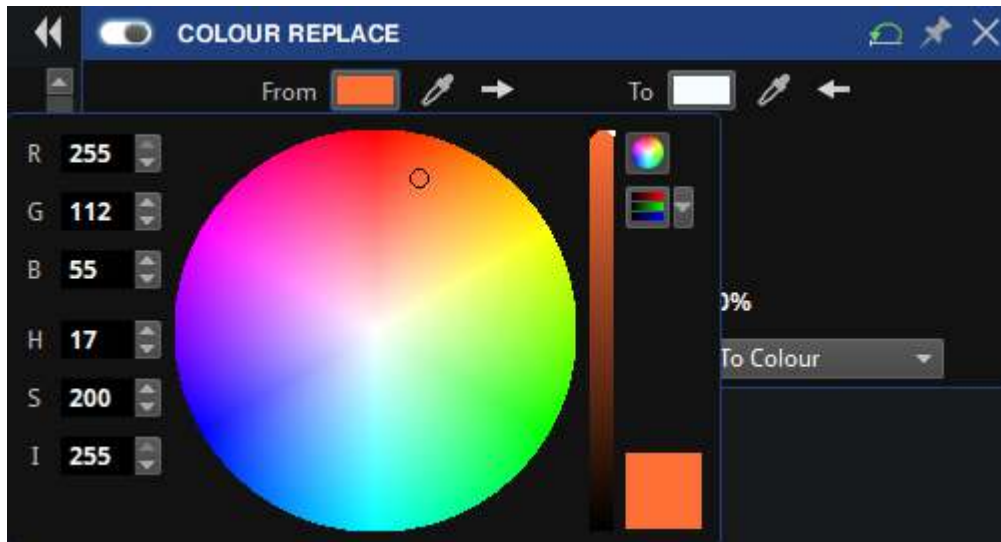

Figure 10-15. Selecting a colour from the colour picker.

- Colour Tolerance: Determines the Hue range that is affected by the modifications.
- Brightness Tolerance: Determines the Brightness range that is affected by the modifications.
- Apply to Hue, Apply to Saturation, Apply to Brightness: These checkboxes apply the tolerance settings to their respective parameters.
- Softness: Determines the amount of softness applied to the edges of the correction matte. The higher the value the smoother the transition between the area affected by the colour change and those areas not affected.
- Strength: Determines how much the modifications affect the original image.
- View Matte: This shows the grayscale correction matte used to show the level of change that occurs for each pixel. White areas show areas affected whilst black areas show areas that remain unchanged.
- Method:
 - Set To Colour directly changes the affected pixels of the To colour
 - Transform To Colour changes affected pixels toward the To colour using HSL interpolation. The amount of change for affected pixels is dependent on how close the pixels are to the From colour.



Figure 10-16. The colour replace pipeline tile indicates which colours have been altered

COLOUR REPLACE EXAMPLES

A red pepper can be changed into green pepper easily. Here is the original red pepper image:



Figure 10-17. Original red pepper

Select a red colour from the from the canvas using the eyedropper tool, and a suitable green from the colour picker:



Figure 10-18. From and To colour chips with red changed to green.

This results in the following:

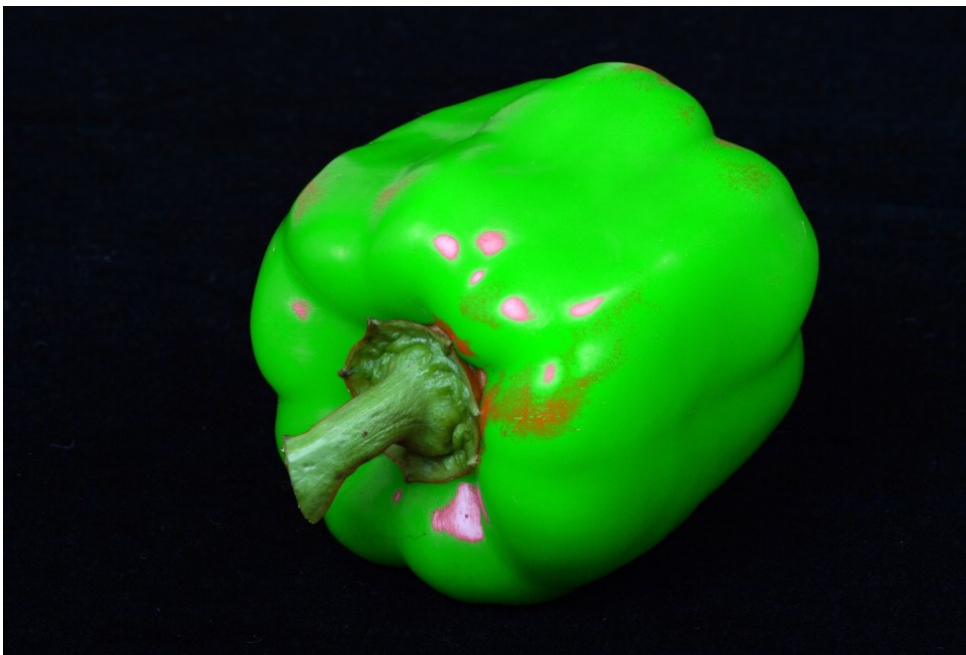

Figure 10-19. The resulting image after the From To operation

To turn the pepper completely green requires some adjustment, in this case increasing the Hue Tolerance parameter to 25%, as seen in the image below:



Figure 10-20. The resulting green pepper after increasing the Hue Tolerance

It is recommended to use the View Matte feature when using Colour Replace, as this shows the areas of the image that will be affected by the colour replace operation.



Figure 10-21. The View Matte feature

14-WAY COLOUR CORRECT



Figure 10-22. 14 way colour correct pipeline tile with all colours adjusted

The 14-way Colour Correct feature allows singular or multiple pre-defined colours to be adjusted without affecting other colours. Hue, saturation and brightness controls are provided for each of the primary, secondary and tertiary colours. Black and white can be adjusted using RGB gains.

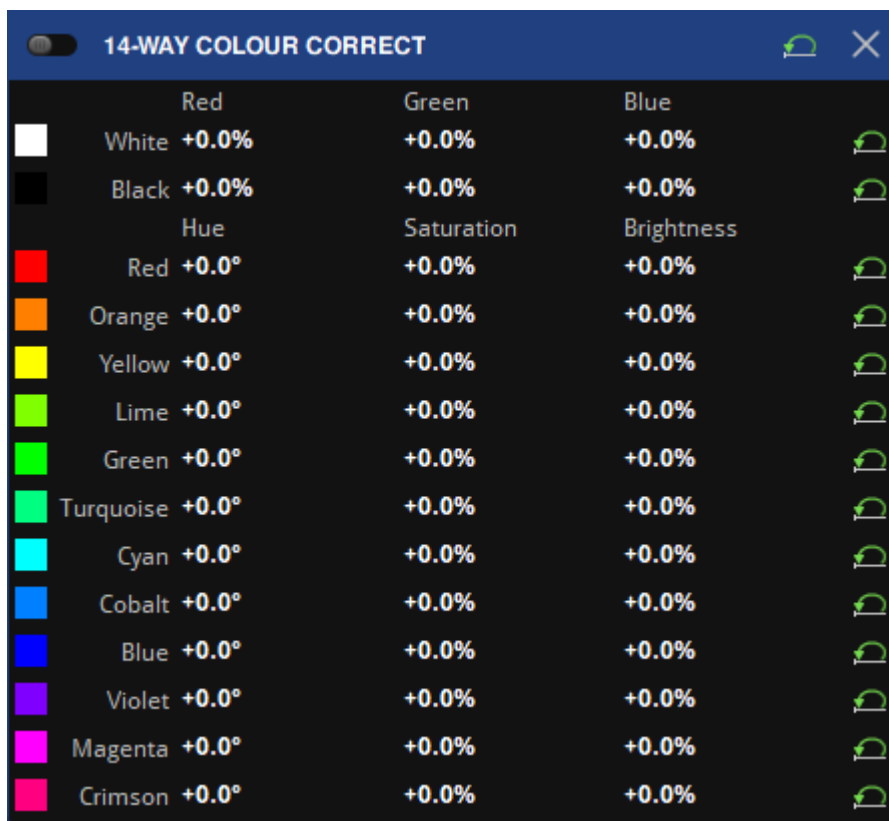



Figure 10-23. 14-way colour correct property editor

Adjustments are made by entering a numerical value, or by clicking and dragging left/right to decrease/increase the value. The values of a colour can be reset to defaults by clicking the reset button , located on the right of each row. The reset icon in the menu title bar will reset all values.

While in the Canvas View, the toolbar icon for 14-way Colour Correct indicates colours that are actively corrected.

CHAPTER 11 - TEST PATTERNS



Figure 11-1. Test Pattern Pipeline tile in deactivated state

PROCESSOR TEST PATTERNS

All Tessera LED processors have a selection of test patterns that can be used to check the performance of fixtures and verify that a fixture layout is correct.

Scrolling test patterns will always move exactly one pixel horizontally and/or vertically, therefore motion should be perfectly smooth. Any juddering, double/dropped frames or tearing between fixtures would indicate issues on the network, issues with the fixtures themselves or their positioning on the canvas.

The three ways to activate test patterns:

- Double-click on the Pattern pipeline tile.
- Click once in the enable button on the property editor title bar
- Click once in the desired test pattern to activate it.

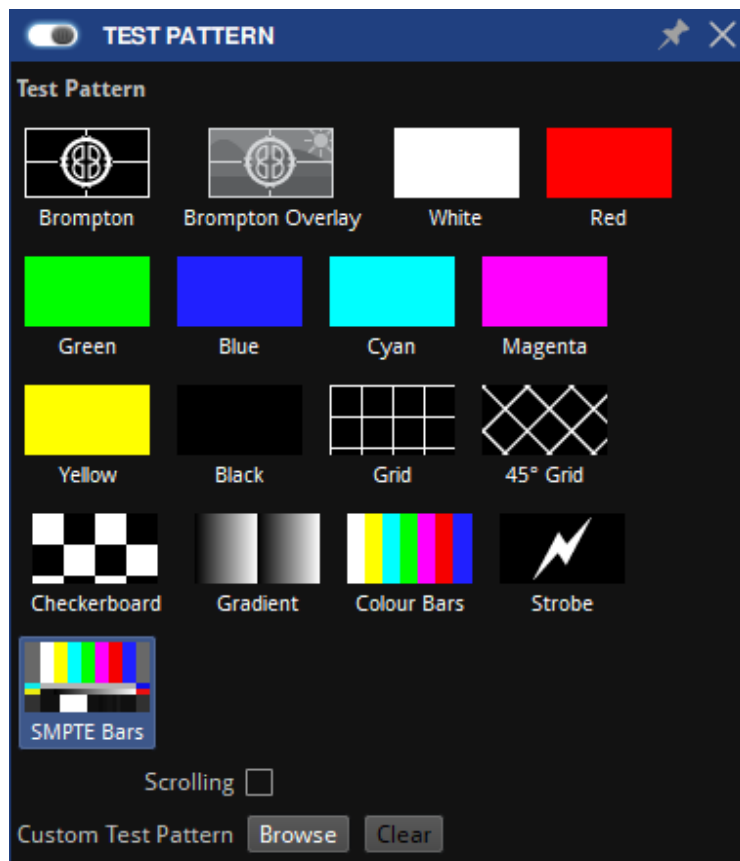

Figure 11-2. Tessera processor test patterns property editor



Figure 11-3. Test Pattern pipeline tile, indicating the current active test pattern

CUSTOM TEST PATTERNS

The Custom Test Patterns section allows for custom images to be loaded into the processor or captured from the video input.



Figure 11-4. Custom Test Pattern Options

To use a custom test pattern, select the Pattern pipeline tile under Override in Canvas View.

- **Browse:** Select an image to be used as a test pattern. Click Browse, select the file, and click OK to confirm selection. Tessera supports a maximum file size of 8MB and supports file types GIF, JPG, PNG, formats.

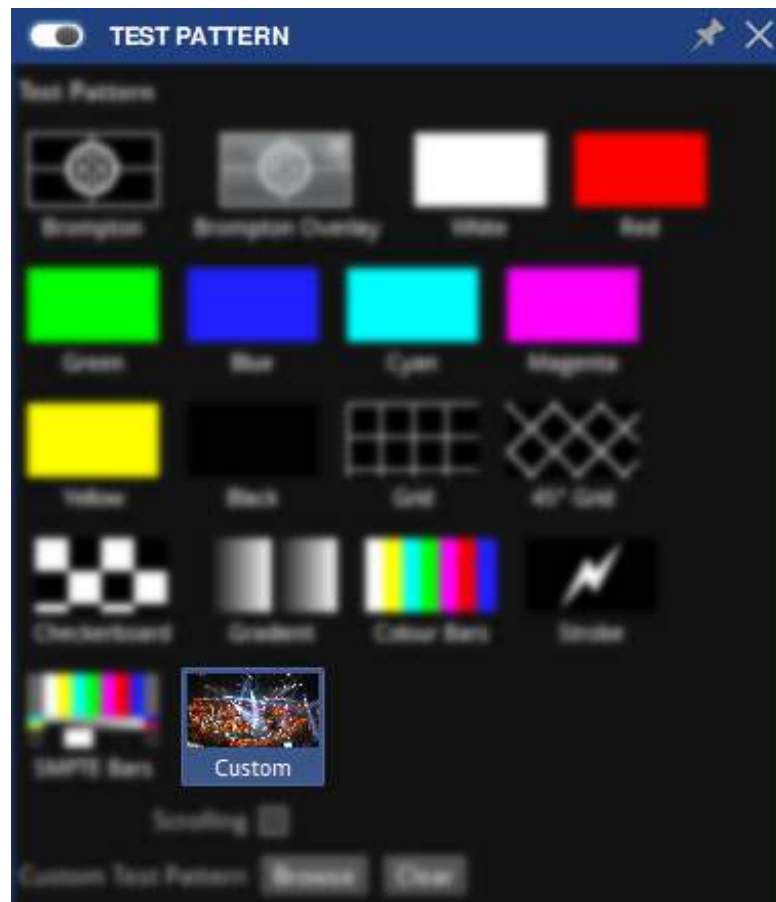

Figure 11-5. Test pattern property editor with custom test pattern selected

- **Video snapshot:** Capture a frame from the currently selected video input.
- **Clear:** Clear the stored custom test pattern.

Processors with a Freeze button on the front panel are given an option to trigger a custom test pattern instead of freezing the screen. To use this feature, select Custom Test Pattern from the Freeze Button Behaviour drop-down menu. See "[Front Panel Button Settings](#)" on page [122](#) for more information.

The front panel buttons can be disabled by unchecking the Enable Buttons checkbox.

FIXTURE TEST PATTERNS

In addition to processor test patterns, individual fixtures also contain a set of pre-programmed test patterns. Individual or groups of fixtures can display patterns by selecting them in Canvas View. See "[Device Properties](#)" on page 48 for more information.

FREEZE/BLACKOUT

Double-clicking the Freeze pipeline tile or pressing the physical Freeze button on the processor will pause the incoming video signal and hold the final frame indefinitely. Pressing the freeze button again will resume live video. Freeze can also be triggered by clicking the enable button  in the Freeze property editor.

Double-clicking the Blackout pipeline tile or pressing the physical Blackout button will cause all panels to display black. Pressing the button again will resume live video. Blackout can also be triggered by clicking the enable button  in the Blackout property editor.

FRONT PANEL BUTTON SETTINGS

Tessera SX40 and S4 LED processors feature 2 buttons on the front panel to freeze or blackout the output on fixtures. By default, these perform the same functions as the buttons in the GUI. The buttons illuminate red while activated.



Figure 11-6. SX40 front panel buttons

The front panel buttons can be disabled from the test patterns property editor on a per-project basis. The Freeze button can also be customised to show a custom test pattern/ bitmap instead of freezing.

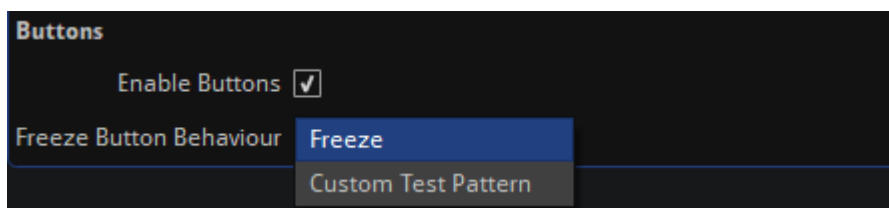

Figure 11-7. Tessera Test pattern property editor, with Freeze button behaviour drop-down menu options

If needed, failover can also be triggered by pressing both buttons at the same time when Tessera SX40 is cabled for Processor redundancy. This can be enabled or disabled in the Failover property editor.

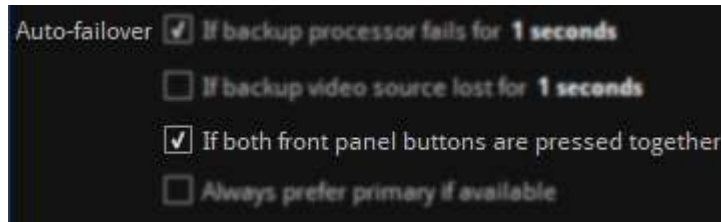

Figure 11-8. 7 Check box to enable failover when both physical buttons on processor are pressed

The front panel buttons can be disabled by unchecking the Enable Buttons checkbox.

CHAPTER 12 - GLOBAL COLOUR

The following controls are available in the Global Colour pipeline tile and apply to all fixtures in a project unless those fixtures (or groups) have been overridden. See "[Per-fixture and Per-group Colour Override](#)" on page 47 for more information.



Figure 12-1. Colour pipeline tile, as shown in Tesseract's user interface

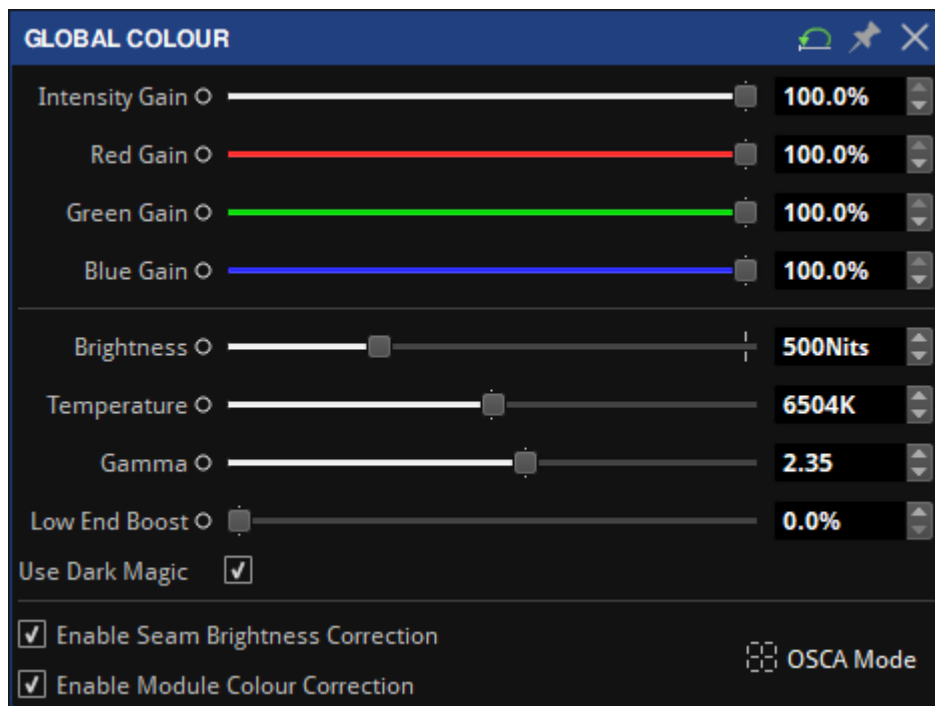

Figure 12-2. Global Colour property editor

INTENSITY

The Intensity Gain slider allows users to modify the luminosity in the input source. As a result, the intensity output of all fixtures will change in a perceptually linear way. For example, at 50% the fixtures will look half as bright to the naked eye as they did at 100%. The precise light output of the screen will depend on this value in conjunction with the Brightness slider.

RGB GAIN

RGB gain modifies the level of each primary colour in the output of the fixtures. Their default value is 100%. Adjusting all 3 RGB sliders to 50% would have the same effect on perceived brightness as lowering the Intensity slider to 50%.

BRIGHTNESS

The brightness slider allows adjustments for light output on fixtures. As all fixture types are calibrated when the profile is written, the brightness slider is expressed in Nits (candela/m²). This means arrays with different fixtures can quickly be set to the same output level.

Where more than one type of fixture with different maximum brightness values is used, the slider has no effect on a fixture's brightness once its maximum value is exceeded. The brightness slider will default using the brightest value that all the fixtures in a project can reach.

Example: If a project consists of two different types of fixtures, one of which has a maximum output of 5000 Nits and another has a maximum brightness of 2000 Nits, the default value of the brightness slider will be 2000 Nits. However, the maximum value of the slider will be the value of the brightest fixture in the project, so in this example it would be 5000 Nits.

Note - To control the brightness of an array including different types of fixtures whilst maintaining relative brightness, leave brightness values at default and modify the intensity slider.

COLOUR TEMPERATURE

The Temperature slider allows the user to adjust the white balance of attached fixtures in a range from 2,000-11,000 Kelvin. By default, this value is set to 6,504K.

GAMMA

Gamma can be modified in a range from 0.2 up to 4.0. Gamma correction is a way to adjust the brightness of mid-tones in the image without affecting the very dark or very bright areas of the image. A higher value results in lower brightness overall.

If images are not gamma encoded, they allocate too many bits or bandwidth to highlights that humans cannot differentiate, too few bits/bandwidth to shadow values that humans are sensitive to, and would require more bits/bandwidth to maintain the same visual quality.

By increasing the differential between areas of shadow and light in parts of the luminance curve of an image or video, it is possible to increase details that can be perceived by the human eye. Gamma correction is done by a simple function, images are encoded with a gamma constant equivalent to about 0.45 and so are decoded with a gamma of approximately 2.2. The gamma value in the processor is set by default to 2.35.

Note - Prior Mac OSX versions to Snow Leopard encoded at 0.55 and hence decoded at 1.8. In order to obtain best results, a lower gamma value on the display output was set. Since Mac OSX Snow Leopard release, Apple has changed their default gamma values to a value more in line with the 0.45/2.2 ratio used by other manufacturers.

DARK MAGIC

LED panels are often run at a lower brightness than their maximum capability, e.g. for indoor and 'on-camera' applications. This results in an unavoidable reduction in effective bit depth, which can lead to visible artefacts such as banding and loss of detail, especially in dark areas of the image.

Enabling Dark Magic will increase the visual quality of the output when operating at low brightness. A small amount of noise may become visible at short viewing distances, therefore in some circumstances when the fixtures are close the viewer, it may be preferable to uncheck the Dark Magic checkbox.

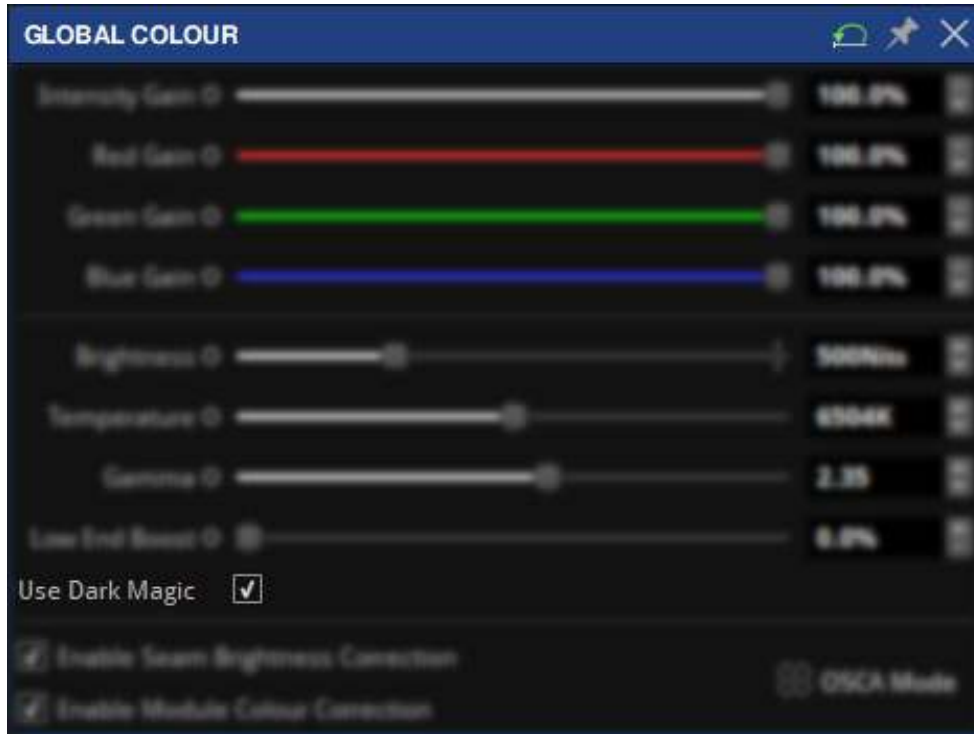

Figure 12-3. Dark Magic Tick box in Global Colour property editor

The greatest improvements can be seen when running very high brightness panels at a much lower brightness, adjusted via the Brightness control.

Dark Magic is available for all Tesseract fixtures that use the R2 receiver card.



Figure 12-4. Dark Magic disabled with visible banding, compared with enabled

LOW END BOOST

As Gamma control adjusts the mid-tones of video content, Low End Boost adjusts the brightness of darker video content areas. For accurate reproduction, this control is recommended to remain at 0%, but in some cases a higher setting can recover detail in dark areas of the content. Excessive levels of Low End Boost may start to reveal limitations in the content such as compression artefacts and camera noise that normally would remain hidden.

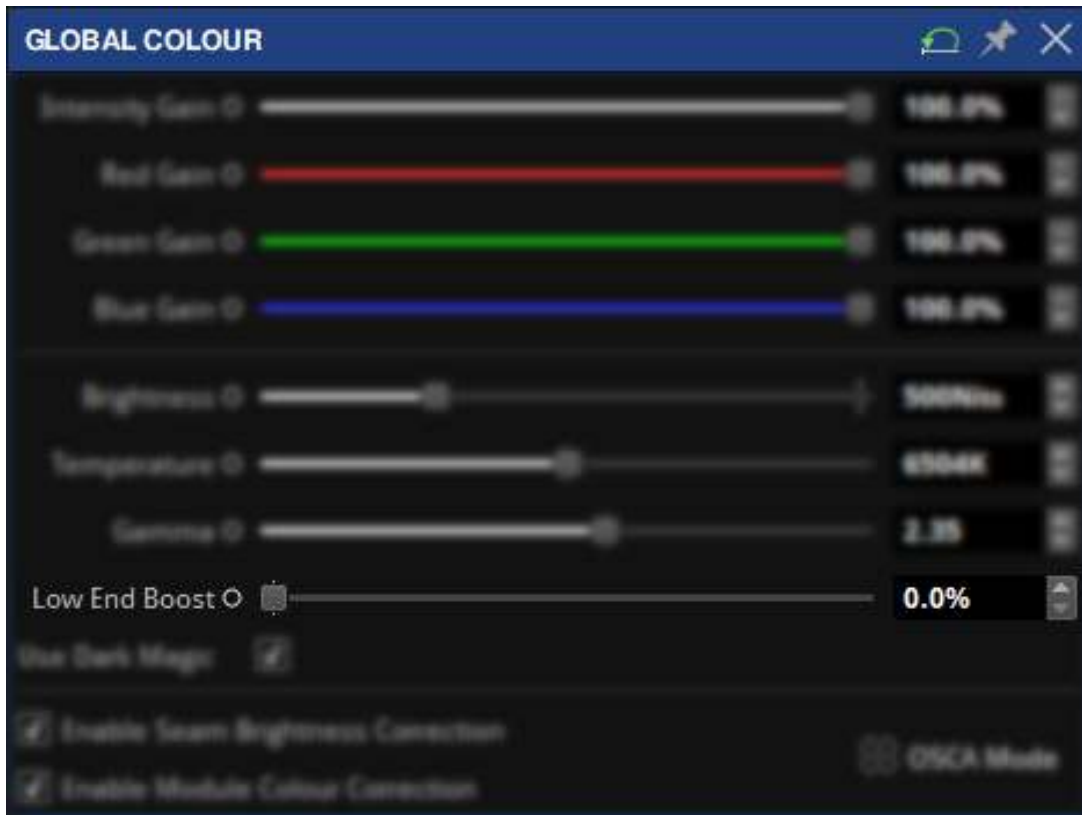

Figure 12-5. Low end boost slider in Global Colour property editor

STUDIO MODE

Studio Mode is a feature specially designed for Tessera fixtures. Studio Mode reduces panel brightness while maintaining the PWM bit depth, resulting in improved image quality and reducing banding when running at low brightness. The maximum benefit is seen on particularly bright panels, especially those running at relatively low PWM bit depth.

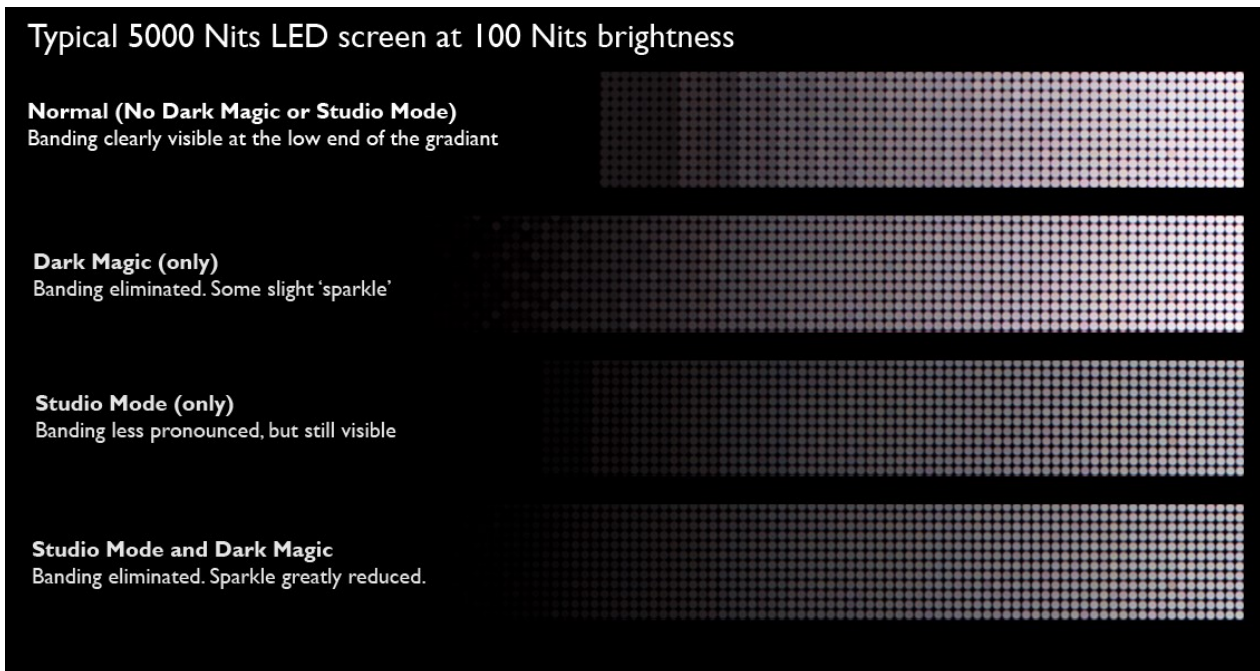

Figure 12-6. A comparison of Dark Magic and Studio Mode

Studio Mode is enabled by selecting the desired panels and enabling the Studio Mode option in the fixture properties editor. See "[Fixture Properties](#)" on page 46 for more information.

At the time of writing this document, the following panels offer Studio Mode:

- ROE BO2 (MC)
- ROE CB3
- ROE CB3 Half
- ROE CB3.125 300x300
- ROE CB3.125 600x150
- ROE CB3.125 900x150
- ROE CB3.125 (NS)
- ROE CB3.125 (NS) Half
- InfiLED ER 5mm
- InfiLED ER 5mm Mini

ON-SCREEN COLOUR ADJUSTMENT

Tessera LED processors feature a comprehensive fixture-based seam adjustment for fixture and module seams, and 7-way colour correction for modules and panels.

OSCA is an abbreviation for On-Screen Colour Adjustment. When in OSCA Mode, the OSCA interface appears on the output fixtures themselves, showing the mouse position and highlighting selected seams, fixtures or modules for quick and intuitive adjustments.

OSCA MODE

OSCA Mode can be accessed by either selecting it in the Tools drop-down menu, clicking the OSCA button located on the property editor in the Global Colour pipeline tile in the Main Project Screen, or using the keyboard shortcut Ctrl+Shift+O.

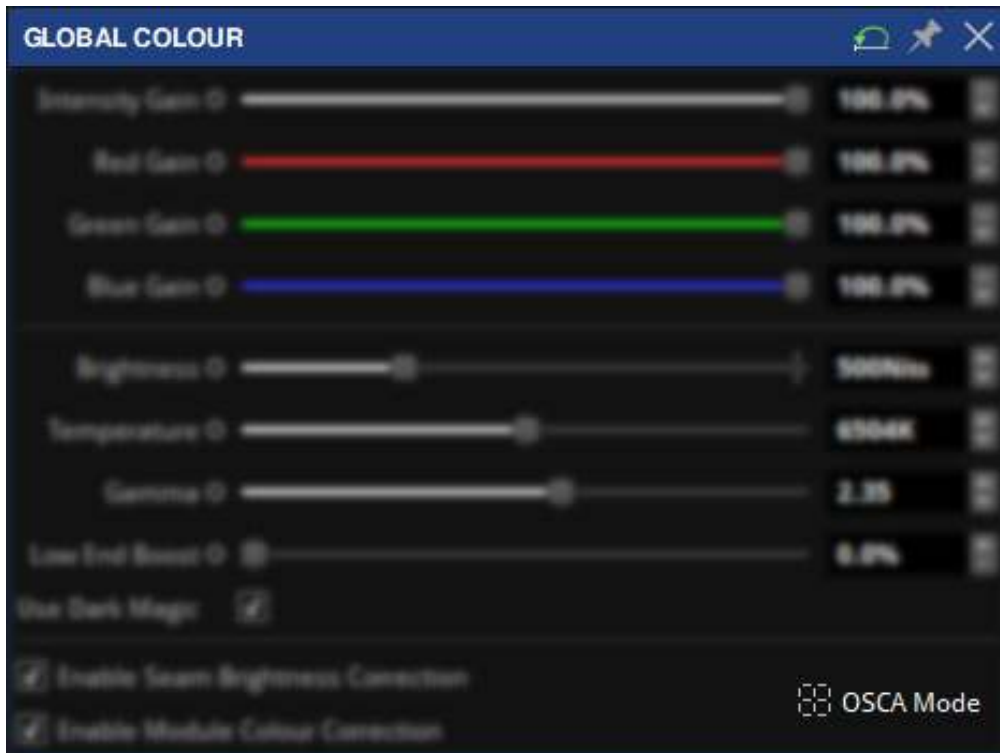

Figure 12-7. OSCA button in the Global Colour property editor

If a video input is currently in use, putting the processor into OSCA Mode will disable the video output.

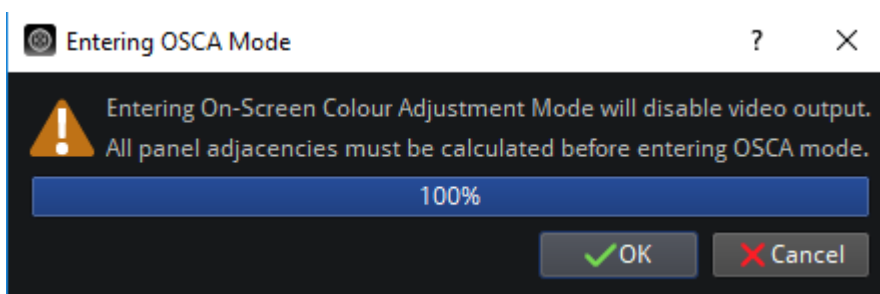

Figure 12-8. The disable video output warning

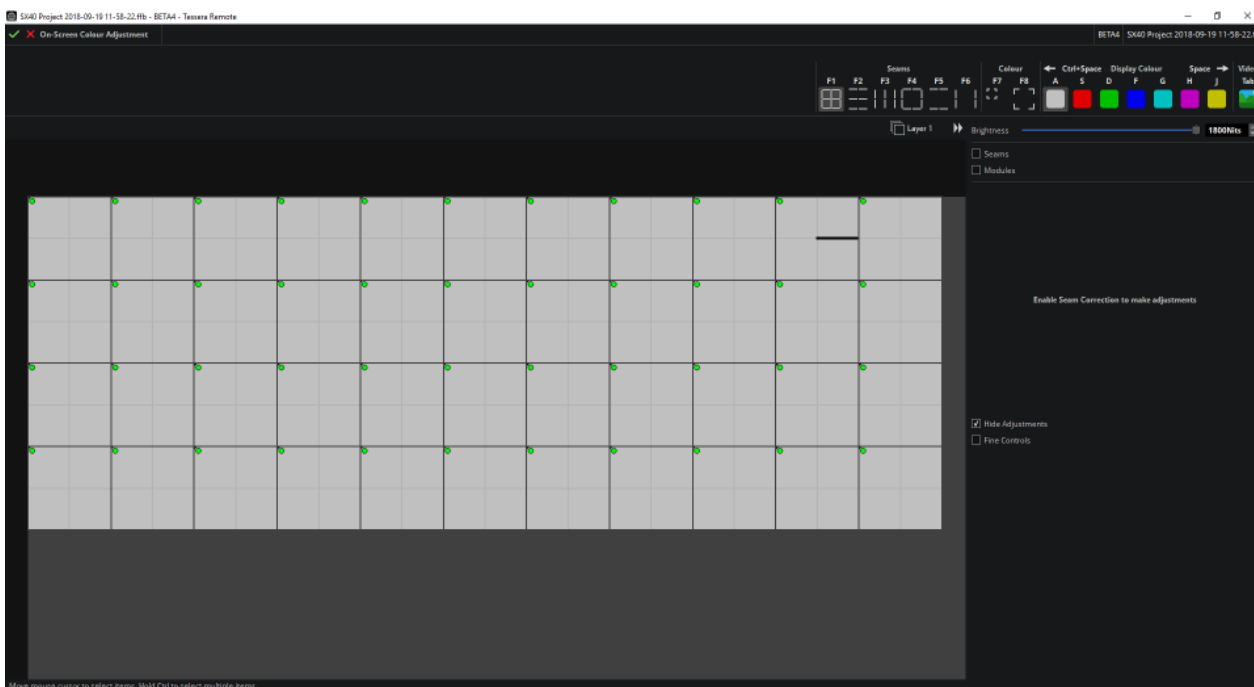

Figure 12-9. The On-Screen Colour Adjustment window

The On-Screen Colour Adjustment window displays the fixtures in the project as they are positioned on the canvas. The mouse can select fixtures or seams and using the keyboard arrow keys will change the selected object. Layers are also supported.

While in OSCA mode, the processor outputs a solid colour on all connected fixtures. By default it is set to white but primary colours (red, green and blue) or secondary colours (cyan, magenta, and yellow) are also available for seam and/or module correction.

DISPLAY VIDEO

Video can be displayed temporarily in OSCA Mode by pressing and holding the Video button on the OSCA toolbar, or by holding the Tab key.

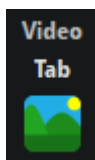

Figure 12-10. The Video button on the OSCA toolbar, click or alternatively press Tab on the keyboard.

OSCA works in one of two modes: Seam Adjustment, which allows the luminance adjustment of fixtures and fixture modules, or Colour Adjustment which allows colour adjustment of fixtures or fixture modules. See [“Seams Adjustment”](#) on page 132 and [“Colour Adjustment”](#) on page 135 for more information.

DISPLAY COLOUR

Changing the colour displayed on the fixtures can help to assess differences in seam luminance, or colour variances between fixtures. The colour can be changed by selecting the colour from the OSCA toolbar or using the keyboard shortcut Space or Ctrl+Space to cycle through the different colours. Pressing the shortcuts keys as marked above the colour pattern buttons will also display the desired colour on screen.

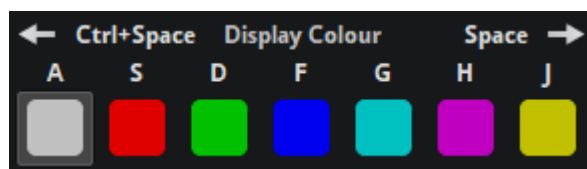

Figure 12-11. The Display Colour section of the OSCA toolbar

Adjustments can be made to white, primary and secondary colours.

When in colour correction mode, the controls only adjust the Master colour of the fixtures and/or the colour of the test pattern being used

BRIGHTNESS SLIDER

OSCA adjustments are performed in the On-Screen Colour Adjustment window. There is a Brightness slider and spin-box to adjust overall the brightness of selected fixtures or modules in Nits.

SEAMS AND MODULES CHECKBOX

The Seams and Modules checkboxes enable or disable the OSCA modifications and allow for adjustments to be made to the fixtures. To access the modification options, the checkboxes need to be enabled.

SEAMS ADJUSTMENT

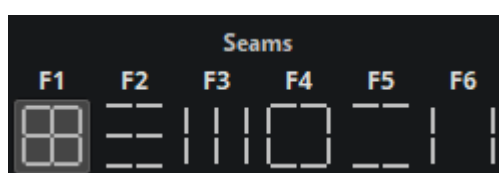







Figure 12-12. OSCA Seam adjustments

Due to mechanical design tolerances, many higher pixel pitch fixtures have issues lining up precisely with adjacent fixtures or can even have slight mechanical misalignment issues between the LED modules that make up the fixture. This can give rise to the appearance of perceived bright or dark lines at the seams of fixtures or modules that is noticeable when viewing certain content.

Seam adjustments allows the user to correct luminance at the seams between fixtures or between adjacent modules within fixtures.

Fixture or module seams can be selected in several different methods. Different seams can be selected by clicking on the relevant seam type on the OSCA toolbar.

Button	Function	Shortcut key
F1 	All modules seams selection	F1
F2 	Modules horizontal seams selection	F2
F3 	Modules vertical seams selection	F3
F4 	Panel all seams selection	F4
F5 	Panel horizontal seams selection	F5
F6 	Panel vertical seams selection	F6

Multiple seams can be selected by using Ctrl+click or click and drag the left mouse button to create a selection box around the seams.

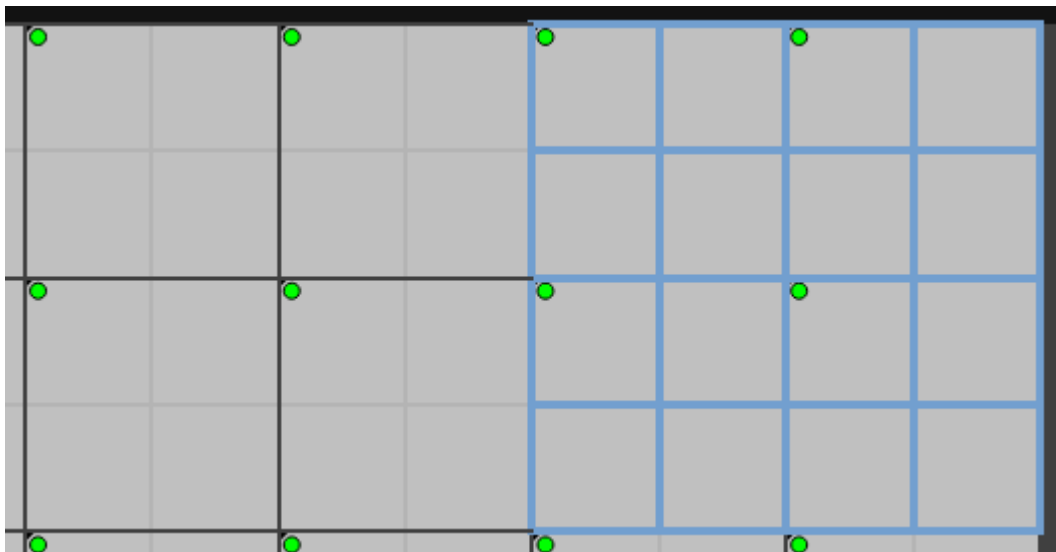

Figure 12-13. Seams selected in All modules seams selection mode

When seams are selected on the OSCA canvas, the relevant seams are highlighted on the physical fixtures.

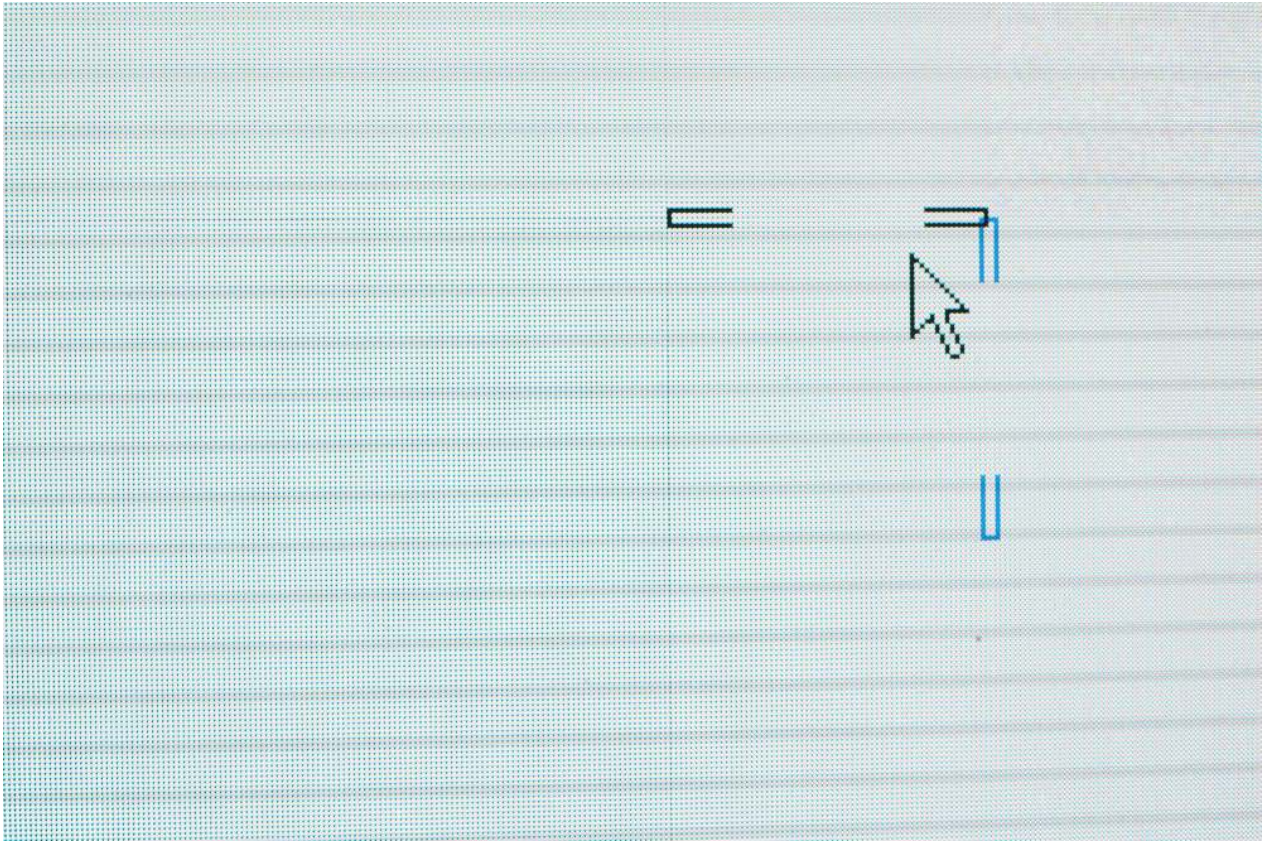

Figure 12-14. OSCA on fixtures showing selected seams and cursor

Once seams have been selected, luminance can be adjusted by:

1. Pressing and holding the 1 key and use either the + and - keys or the up and down arrows on the keyboard to increase or decrease luminance.
2. Click and drag with the mouse over the blue and white Luminance thumbwheel.
3. Hover the mouse pointer over the Luminance thumbwheel and use the mouse scroll wheel to scroll up or down to adjust.

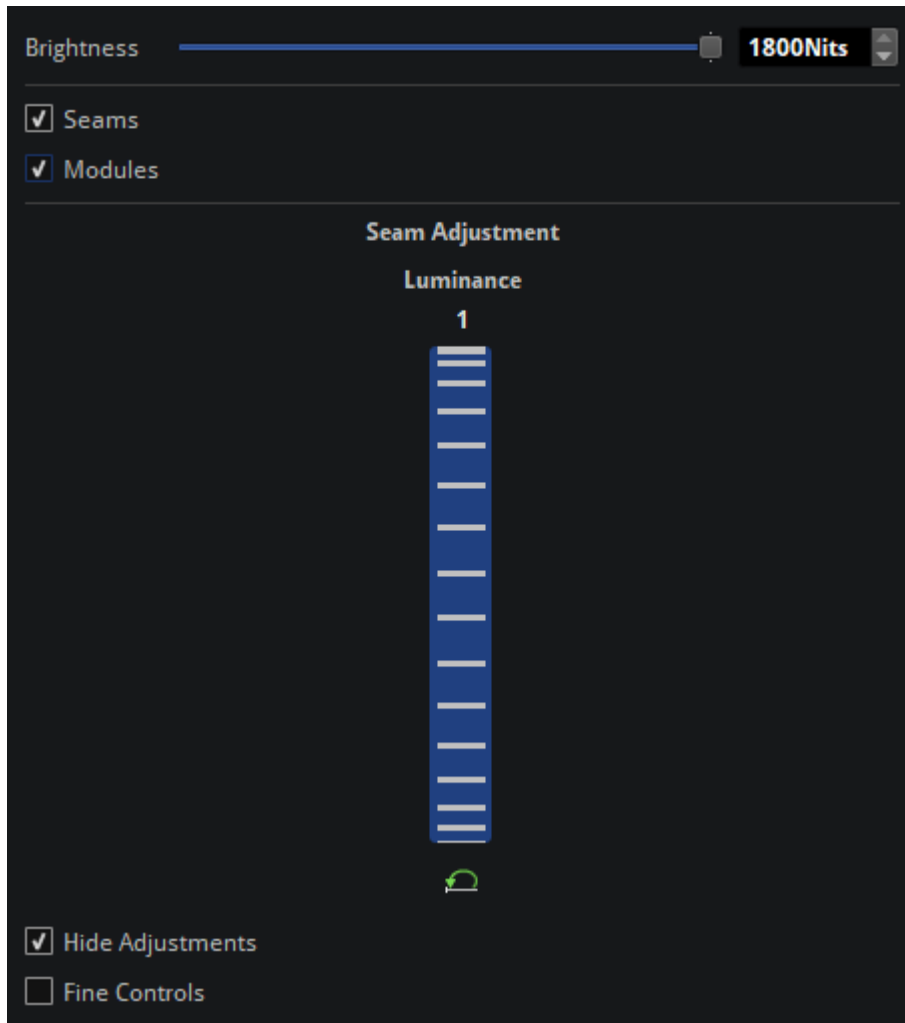

Figure 12-15. Seam Brightness Correction property editor, displaying luminance thumbwheel

The Seam Brightness Control panel features a Layers selection. Currently displayed layers are checked, to 'hide' layers, uncheck the corresponding check-box. Hidden layers do not output whilst in OSCA Mode. See "[Layers](#)" on page [85](#) for more information.

- Hide adjustments: When adjustments are being made, the selection is hidden for a better view of the modifications. Disable this option to keep the selection always active.
- Fine controls: Enabling Fine controls gives the user the finest amount of control, a single key press adjusts to give the smallest change possible compared to the default mode where changes are substantial. Alternatively, press and hold the Ctrl key while using Fine Control.
- Reset: The Reset button under the Luminance thumbwheel allows the original luminance value to be restored.

COLOUR ADJUSTMENT

Occasionally when using different batches of the same LED fixtures together the LEDs may have aged differently, or the fixtures may have slightly different calibrations. Colour Adjustment offers 7-way colour correction to quickly match fixtures which appear to have different in colours or brightnesses.

Note - OSCA adjustments do not overwrite existing fixture colour calibrations. OSCA is a fixture-based adjustment and OSCA values are stored within the fixture. This means the adjustments travel with the panels themselves, so if a LED wall is re-assembled from fixtures in a different order, the OSCA adjustments can be used with the new fixture order.

To adjust colour for selected modules, select the Module icon or press F7. For fixtures, press F8 or select the Fixture icon on the OSCA toolbar.



Figure 12-16. Icons for selecting module or fixture Colour Adjustment on the OSCA toolbar

The following figures show a selection of fixtures or modules respectively:

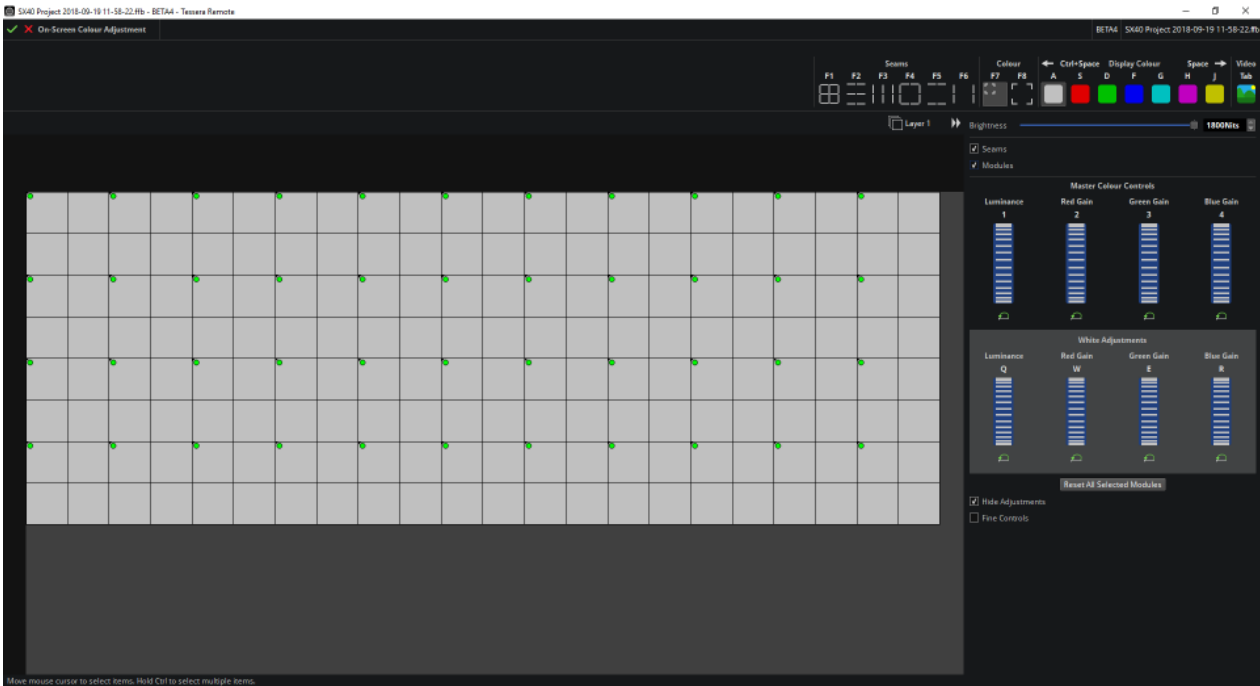

Figure 12-17. The canvas showing module selection mode for Colour Adjustment

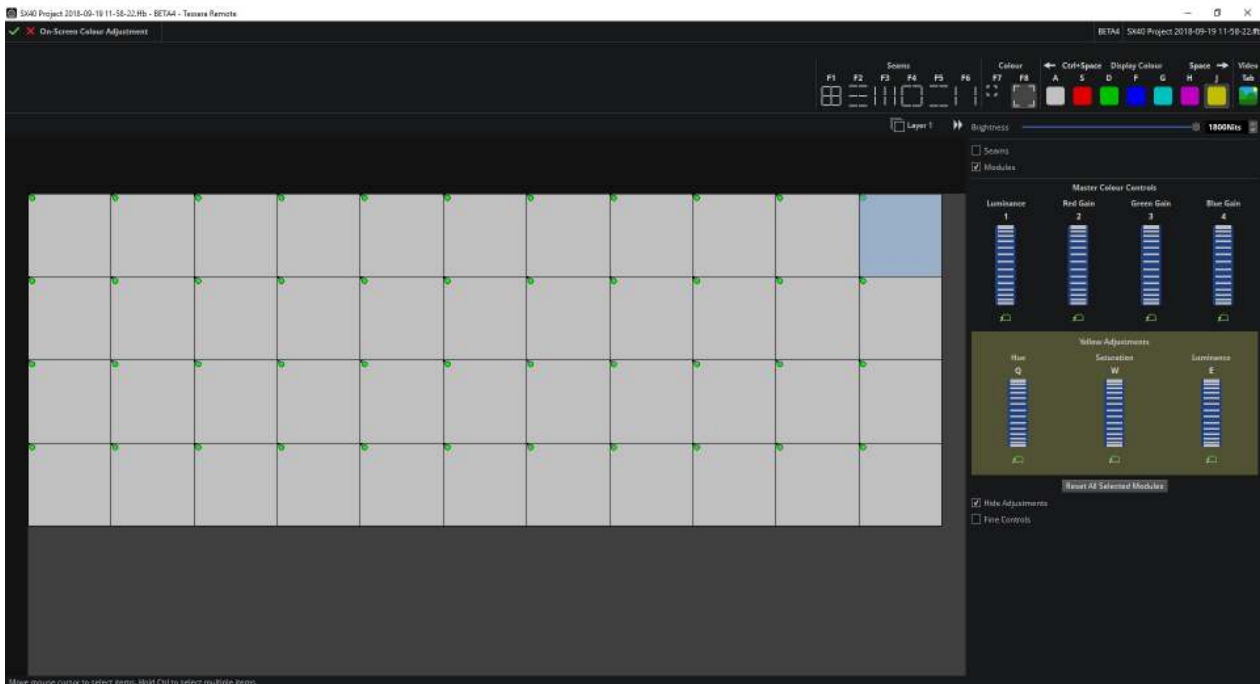

Figure 12-18. The canvas in fixture selection mode for Colour Adjustment

Once modules or fixtures colour correction is selected, the Colour Adjustment panel is shown. The properties can be adjusted:

1. Press hold the shortcut key and use in conjunction with the + and - keys or the up and down arrows to increase and decrease values.
2. Click and drag with the mouse over the thumbwheel.
3. Hover the mouse pointer over the thumbwheel and use the mouse scroll wheel.

The shortcuts will only affect the selected colour. Selecting a colour offers the following settings:

Master Colour (affects all colours)	Shortcut Key
Luminance	1
Red Gain	2
Green Gain	3
Blue Gain	4

Selected Colour (white)	Shortcut Key
Luminance	Q
Red Gain	W
Green Gain	E
Blue Gain	R

Selected colour (Primary or Secondary)	Shortcut Key
Hue	Q
Saturation	W
Luminance	E

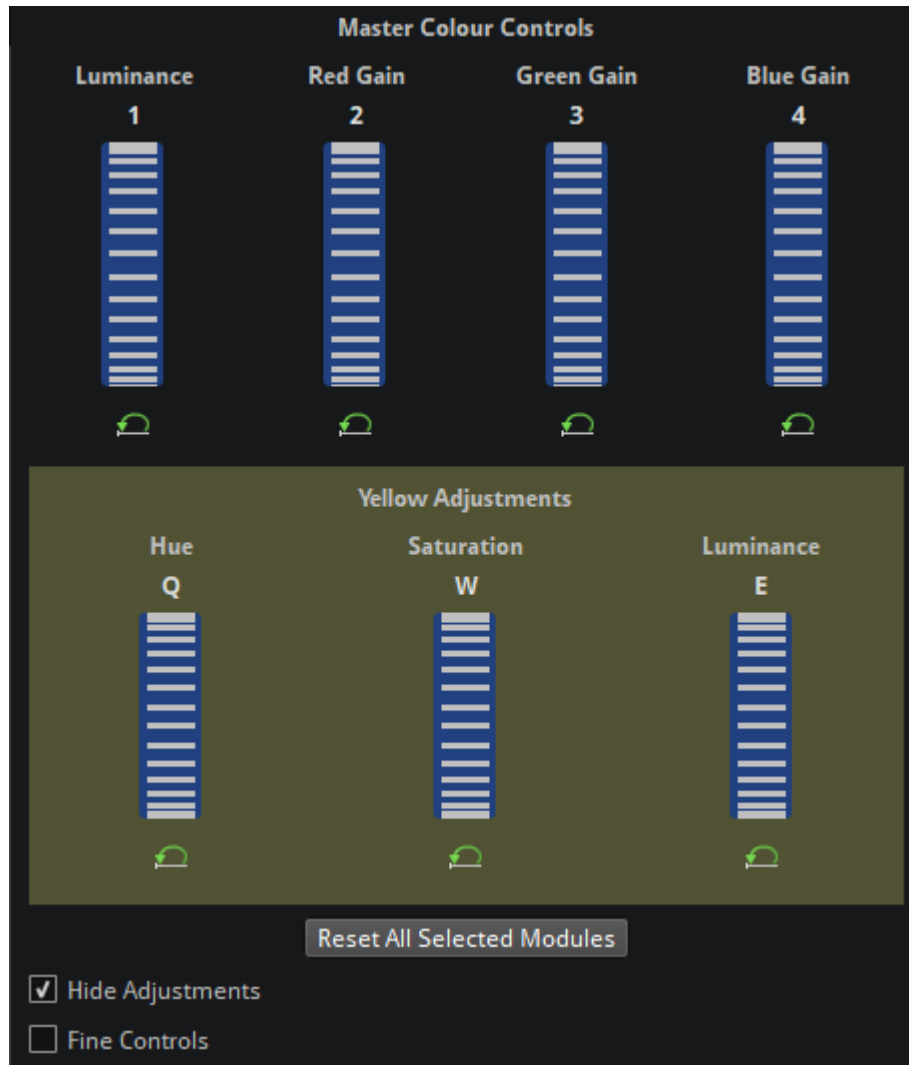

Figure 12-19. Yellow Adjustments

- Hide adjustments: When adjustments are being made, the selection is hidden for a better view of the modifications. Disable this option to keep the selection always active.
- Fine controls: Enabling Fine controls gives the user the finest amount of control, a single key press adjusts to give the smallest change possible compared to the default mode where changes are substantial. Alternatively, press and hold the Ctrl key while using Fine Control.



Figure 12-20. The Colour Adjustment panel showing Master Colour

- Reset: If needed, the modifications values of each parameter can be reset in the selected modules using the reset button. To delete all the modifications done to the selected modules, press the Reset All Selected Modules option located below the adjustments thumbwheels.

CONFIRMING OSCA SETTINGS

After seams, fixtures or modules have been colour-corrected, click the green tick on the top left of the interface to confirm and store the OSCA settings. Clicking the red cross will cancel all OSCA adjustments within this session. Clicking either button returns the user to canvas view.

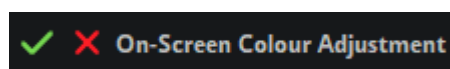

Figure 12-21. Confirming or canceling OSCA changes

COPYING AND PASTING OSCA SETTINGS

Copy: OSCA settings can only be copied from a single module, copying from multiple modules is not supported. In OSCA mode, select a single module, right-click and select Copy OSCA colour settings.

Paste: Settings can be pasted to single or multiple modules simultaneously.

1. Select multiple modules by holding Ctrl.
2. Once selection is complete right-click one of the selected modules.
3. Click Paste OSCA colour settings to apply copied values to all selected modules.

When pasting OSCA settings, all the OSCA colour settings will be overwritten. OSCA seam adjustments are not affected.

If using Tessera Remote, it is possible to copy OSCA colour settings from one processor to another. From processor 1, copy the OSCA colour settings and paste them to connected fixtures in the OSCA window of processor 2.

IMPORTING AND EXPORTING OSCA SETTINGS

Export:

1. In OSCA mode, select a single fixture and right-click it.
2. Select Export OSCA colour settings.
3. Select a location to export the data (e.g. USB storage), and the colour adjustments will be written to a file.

Import:

1. Select the target modules (on the same, or a different processor) and right-click.
2. Select Import OSCA colour settings.
3. Select the previously-exported file. The colour adjustments will be read from the file and sent to all selected modules.

As with copy and paste, colour settings for all colours will be overwritten, regardless of which colour is currently used. OSCA seam adjustments are not affected.

OSCA KEYBOARD SHORTCUTS

General OSCA Shortcuts:

Function	Shortcut Key
Seam selection mode	F1 - F6
Module Colour Adjustment	F7
Fixture Colour Adjustment	F8
Display white	A
Display Red	S
Display Green	D
Display Blue	F
Display Cyan	G
Display Magenta	H
Display Yellow	J
Display Video	Tab
Change Display Colour forwards	Space
Change Display Colour backwards	Ctrl+Space

OSCA Colour And Luminance Adjustments

Function	Shortcut Key
Luminance Adjustment	1
Red Gain	2
Green Gain	3
Blue Gain	4

Function	Shortcut Key
Increase/decrease parameter	Click+Scroll Wheel
Hue	Q
Saturation	W
Luminance	E
Decrease parameter	-
Increase parameter	+
Fine Adjustment	Ctrl+parameter shortcut

White Adjustment

Function	Shortcut Key
Luminance Adjustment	Q
Red Gain	W
Green Gain	E
Blue Gain	R

Red, Green, Blue, Cyan, Magenta And Yellow Adjustment

Function	Shortcut Key
Red Gain	Q
Green Gain	W
Blue Gain	E

CHAPTER 13 - NETWORK

NETWORK LOAD

The Network Property Editor displays the network load on each Tessera output. The greater the network load, the further the green bar fills. The processor will issue a warning once an output is overloaded. If this happens the bar will turn red, consider moving fixtures to other outputs or decrease the network bit depth.

Note - When changing fixtures between ports, they will be re-associated automatically, the processor will read the MAC address to re-associate the fixtures. See [“Assigning or modifying online fixture topology”](#) on page 58 for more information.

In the example image below, the system load shows an overview of the processors network load capacity. The letters A and B correspond to each 10G port of the processor, the network load for each ethernet port on the XD unit is also displayed.

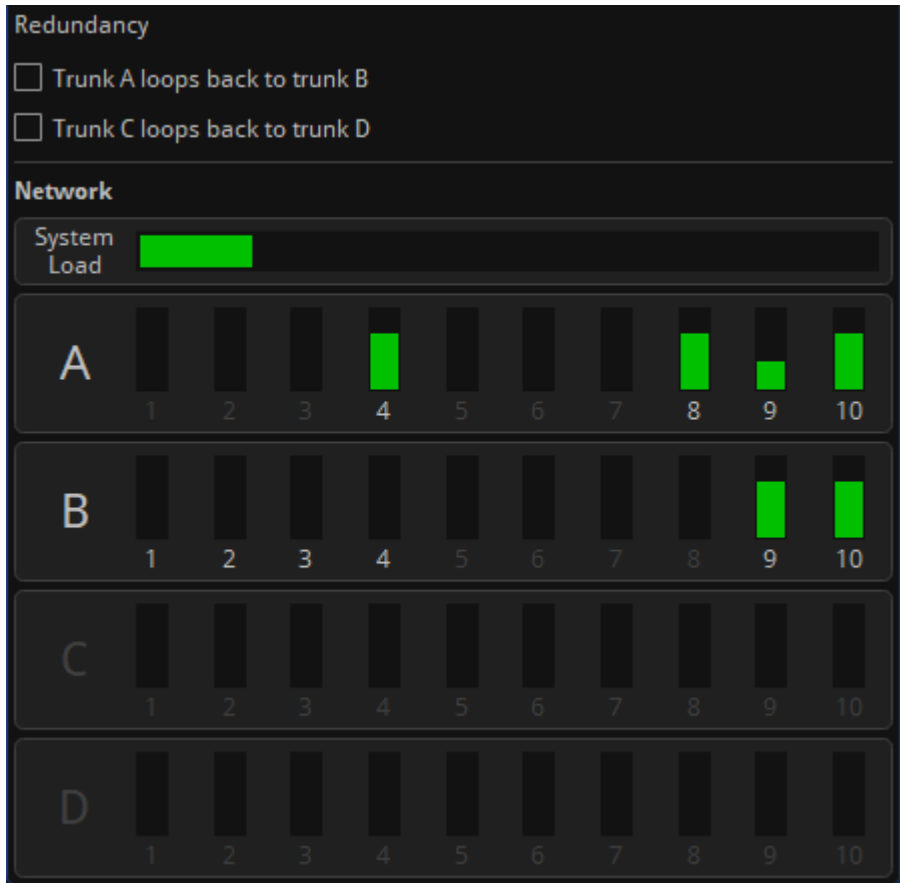

Figure 13-1. Network property editor on Tessera SX40 showing XD units connected to the processors 10G ports

See [“Output Capacity”](#) on page 27 for more information about the port load.

NETWORK BIT DEPTH



Figure 13-2. The Network Bit Depth drop-down menu

Network bit depth refers to the bit depth at which video data is encapsulated, packetized and sent to connected fixtures.

Front-side processing is always 12 bit and is unrelated to Network bit depth. Processing bit depth is always 16 bit and is also unrelated to Network bit depth.

By default, network bit depth is 12 bit, however can be changed to 8 or 10 bit. Reducing bit depth allows for increased pixel capacity at the cost of image quality. Depending on the source this can also affect the adjustment of parameters such as RGB gain, brightness and contrast. The network bit depth should always be equal or better than the input source bit depth. For example, DVI is 8 bit and SDI is 10 bit.

GENLOCK SETTINGS

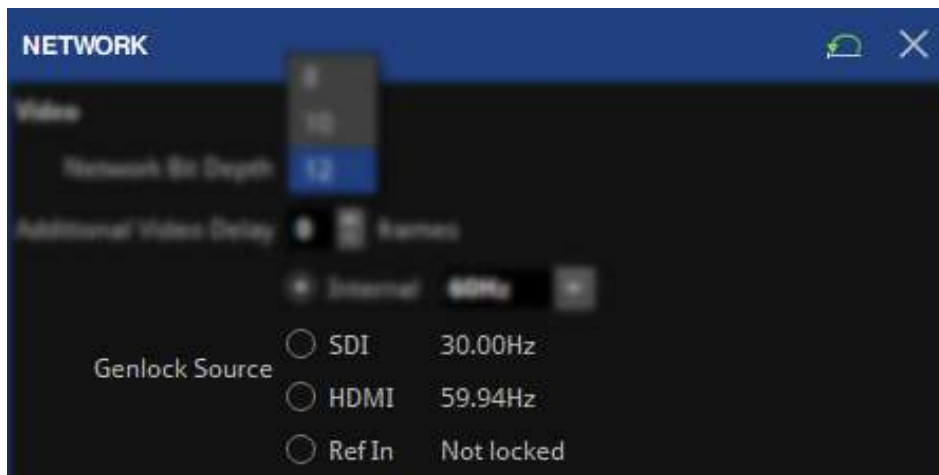

Figure 13-3. Genlock Settings on the Network property editor

INTERNAL

The internal setting allows an overall refresh rate for the processor to work from 23.98 up to 60 fps. Irrespective of the input source frame rate. The processor will automatically compensate where the source frame rate and the internal refresh rates are different.

REFERENCE IN

Tessera M2 and SX40 processors can synchronise their system and panel refresh to an external bi-level or tri-level reference. The processor will automatically compensate for sources that do not match the refresh rate of the external reference. The external reference can also be another Tessera processor with a source connected.

LOCKING TO VIDEO INPUTS

Tessera processors can lock their refresh rate to the incoming source, regardless of the inputs. The processor will automatically compensate for sources that do not match the selected source refresh rate.

Note - The selected genlock frame rate affects the capacity of each Tessera output port. See "[Output Capacity](#)" on page 27 for more information.

If the frame rate of the video input differs from the reference, whether it is internal, another video input or a bi-level or tri-level sync, the processor will match the frame rate by either doubling or dropping frames. For critical synchronisation between two or more processors, the incoming frame rate should match the referenced frame rate.

ADDITIONAL VIDEO DELAY

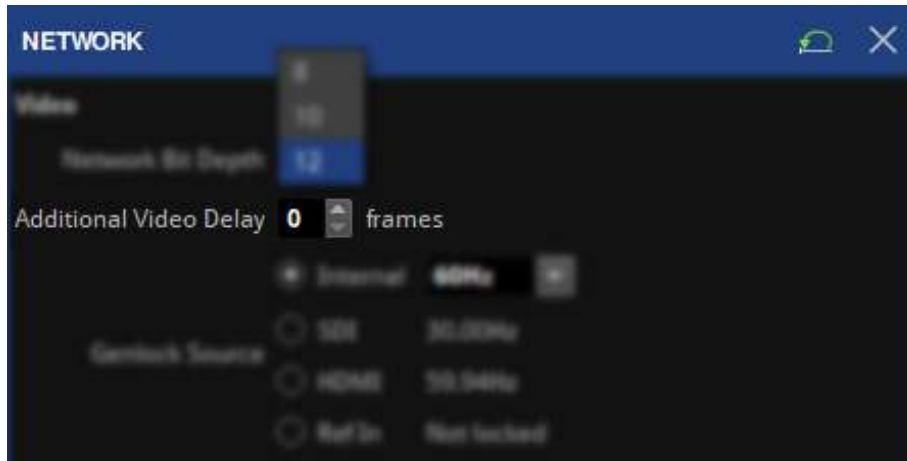

Figure 13-4. Network property editor, setting additional video delay

Additional video delay allows the output refresh to be delayed by up to 5 frames. This allows Tessera LED processors to match the latency present in other display systems. See "[Combining processors](#)" on page 29 for more information.

CHAPTER 14 - LIVE CONTROL



Figure 14-1. Live Control pipeline tile

Live Control allows users to control and modify the colour, video and position parameters of the processor remotely using the industry standard DMX, Art-Net or sACN protocols or using the Tesseract Control application available for Windows and Mac OS.

Live Control can provide flexible control of the Tesseract system, ranging from using a DMX fader desk controlling a single parameter, to controlling multiple groups across several processors. Live Control can be used to integrate processors into larger control systems and provide reactive control to external factors such as adjusting panel brightness in outdoor environments.

Parameters can be controlled directly so their values correspond to a DMX channel(s) or values can be stored into presets and recalled using Live Control.

The following terms will help us to navigate the systems live control functions.

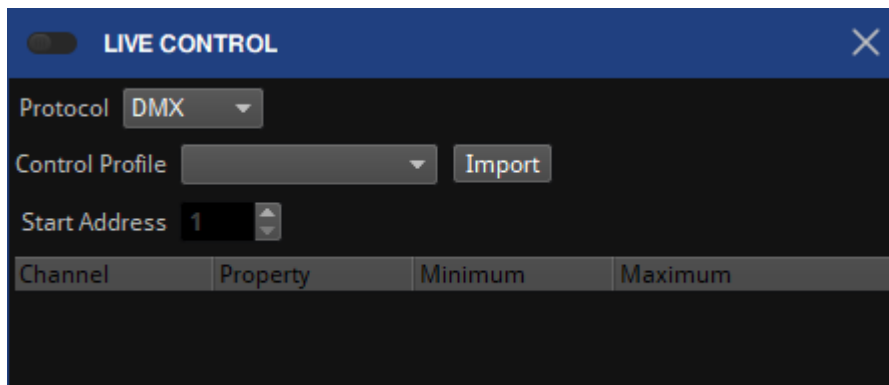

Figure 14-2. Live Control property editor

Processor Parameter: Any parameter on the processor that can be controlled with Live Control.

Control Profile: A control profile, used for DMX, Art-Net or sACN control, contains information about the parameters and assignable items that can be controlled when using that Control Profile and maps to specific channels. A Control Profile is not required when using the Tesseract Control application.







Protocol: Denotes the protocol which is being used to control the processor. This can be DMX (via the 5 pin XLR input), Art-Net or sACN (via the network connection), or the Tesseract Control protocol which allows control of multiple processors from the Tesseract Control application.

ENABLING LIVE CONTROL

Live control can be enabled by double-clicking the pipeline tile or enabling from the property editor. The pipeline tile displays the active button on when live control is enabled. Once enabled, any parameters included in a selected control profile will go to the value defined by the incoming DMX, Art-Net or sACN signal. When live control is disabled the parameters will return to the value set by the GUI before DMX was enabled.

Note - If the DMX or eDMX signal is lost, changes will remain for as long as the Live Control pipeline tile is enabled.

The Live Control pipeline tile indicates the six different states.

Pipeline Tile	Status	Description
	Offline	The Offline tile appears in Tessera Remote offline projects. This indicates that there is no processor connected and is therefore offline. This is the only tile for an offline project file, even when a control protocol has been selected and will remain offline until the project is connected to a processor
	Protocol not selected	If a protocol has not been selected, it will show a Disabled label. This is the default setting for a new online Project File
	Protocol selected but not receiving a valid signal	When a protocol is selected but a valid input signal is not detected, the active light will be OFF and the protocol name will remain in red letters.
	Protocol selected, receiving a valid signal	When a protocol is selected, the system is configured, and a valid DMX or eDMX signal is being received it will show the protocol type in green letters but the active light will remain OFF. The parameters will be responding to the GUI, and not the incoming signal, because live control is not enabled.
	Live Control Enabled, not receiving valid signal	When a protocol is selected but a valid input signal is not detected, the active light will be ON but the protocol name will remain in red letters. The controlled sliders will default to either the last valid signal received or the GUI values before live control was enabled.
	Live Control Enabled, receiving a valid signal	When a protocol is selected, the system is configured, and a valid DMX or eDMX signal is being received it will show the protocol type in green letters and the active light will be ON. The processor parameters included in the selected live control profile will be responding to DMX.

PARAMETER INDICATORS

When Live Control is enabled, the controlled parameters will display a red dot next to their GUI control. They will display their current value but cannot be adjusted manually until live control is disabled.



Figure 14-3. Control profile configured with Live Control active

When it is disabled, the dot next to the controlled parameters will show only the white border. Their values will be enabled for manual adjustments.

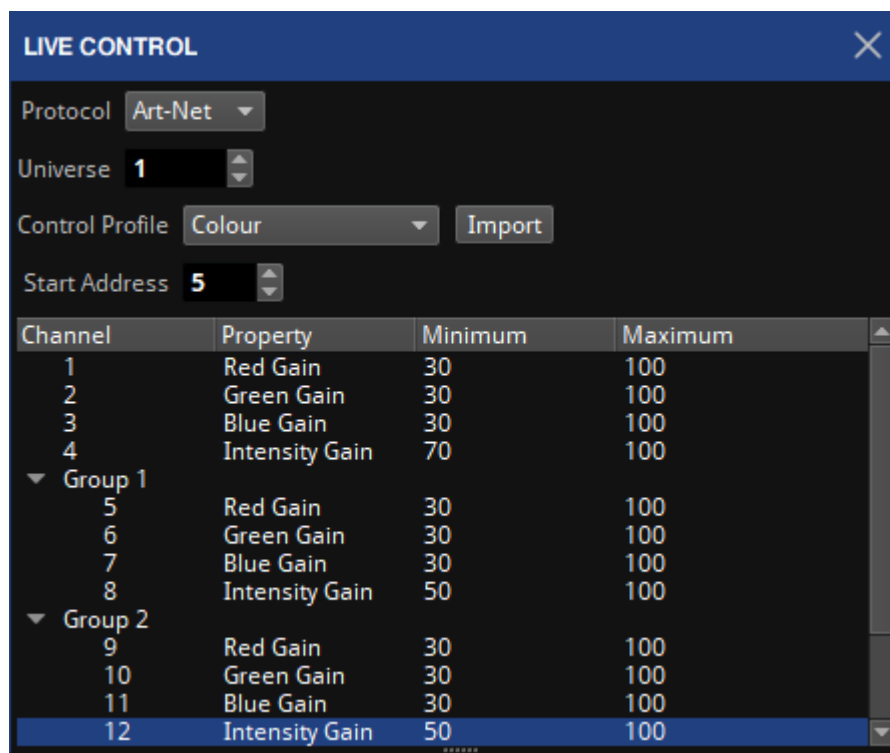

Figure 14-4. Control profile configured, and Live Control disabled

CONTROL PROFILES

Tessera Processors contain a selection of control profiles with various parameters for DMX, Art-Net and sACN modes only. The default profiles cover most use cases, options to modify and create new custom Control Profiles are also available.

The default control profiles contained are:

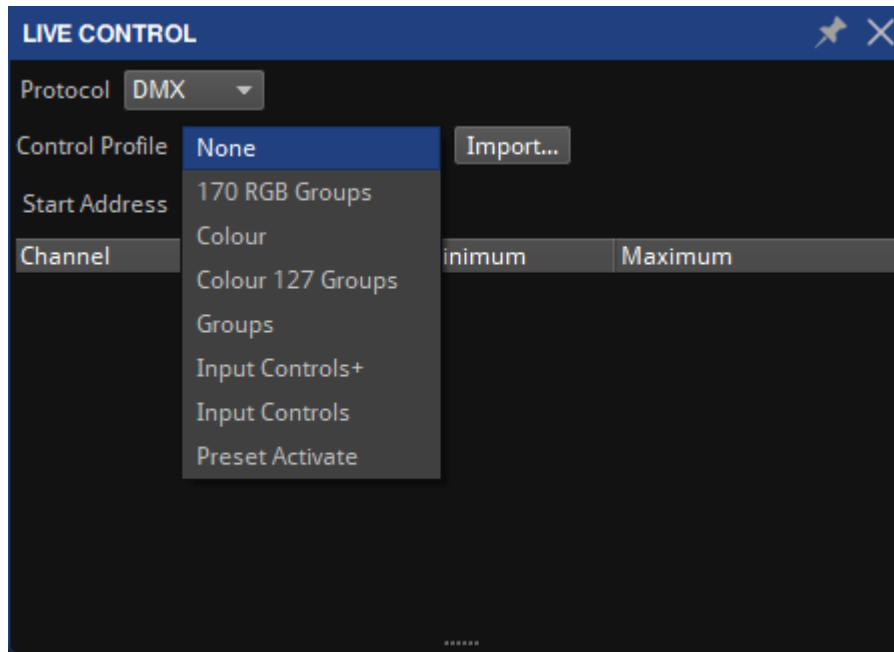

Figure 14-5. Live Control property editor, displaying Control Profile options

Control Profile	Parameters
170 RGB Groups	(510 Channels total if fully assigned) 170x Group assignable sets of Red, Green, Blue
Colour	(28 Channels total if fully assigned) 1x Global control of Red, Green, Blue and Intensity Gain 6x Group assignable sets of Red, Green, Blue and Intensity Gain controls
Colour 127 Groups	(512 Channels total if fully assigned) 1x Global control of Red, Green, Blue and Intensity Gain 127x Group assignable sets of Red, Green, Blue and Intensity Gain controls
Groups	(60 Channels total if fully assigned) 6x Assignable sets of group position, orientation and Red, Green, Blue and Intensity Gain controls
Input Controls+	(38 channels total if fully assigned) 1x Global control of Red, Green, Blue and Intensity Gain 3x Assignable controls of Input Colour management parameters 1x Test pattern trigger channel 1x Freeze trigger channel 1x Blackout trigger channel 1x Preset activation channel to trigger up to 127 user-definable presets
Input Controls	(30 channels total if fully assigned) 3x Assignable controls of Input Colour management parameters
Preset Activate	(1 Channel) 1x Channel to trigger up to 127 user-definable presets

Since some of the sets of parameters that make up these profiles are repeated, and some are common to more than 1 profile it is possible to control all the profiles with 5 suggested DMX libraries. These can be found at C:\Installation path~\Tessera Remote XXX.

ASSIGN CONTROLS TO A GROUP OR INPUT

Some Control Profiles contain multiple sets of group or input controls that allow users to assign each set of controls to a single group (of fixtures) or input (DVI, SDI or HDMI).

This control is in the form of a drop-down menu for each set in the Channel column. When a new profile is selected, all user assignable sets will have the legend "No assigned group" or in the case of input controls "No assigned video input".

FOR FIXTURE GROUPS

Clicking on this legend will reveal a drop-down menu showing all available fixture groups created within that project file. Please note: if no fixture groups have been created, the menu will state None but once fixture groups are created, they will appear in the order of user creation.

Note - It is important to remember that a group can be composed of a single panel.

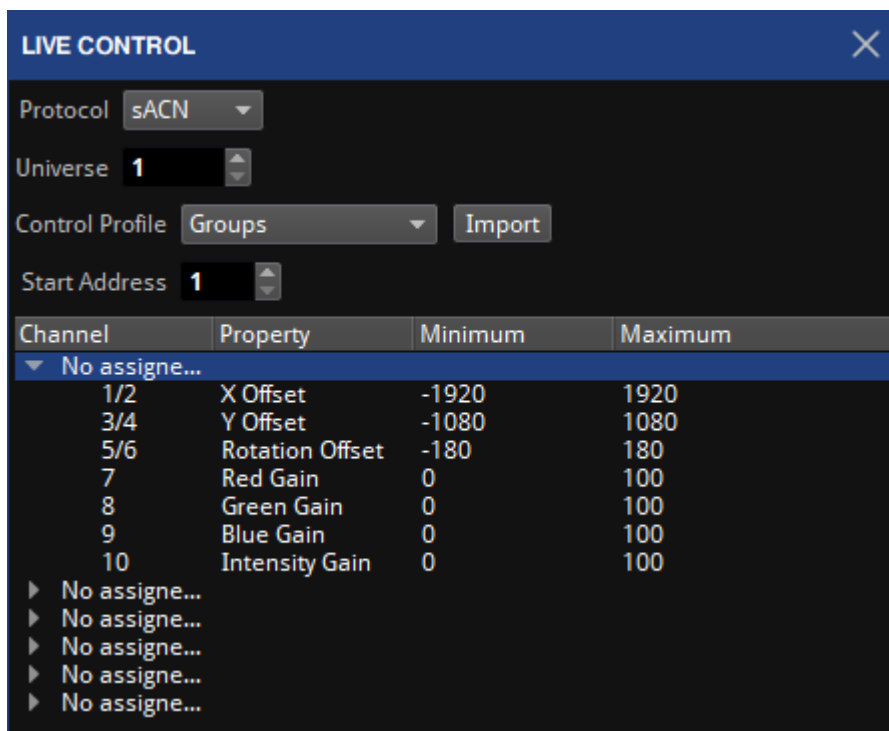

Figure 14-6. Configuring group profile control

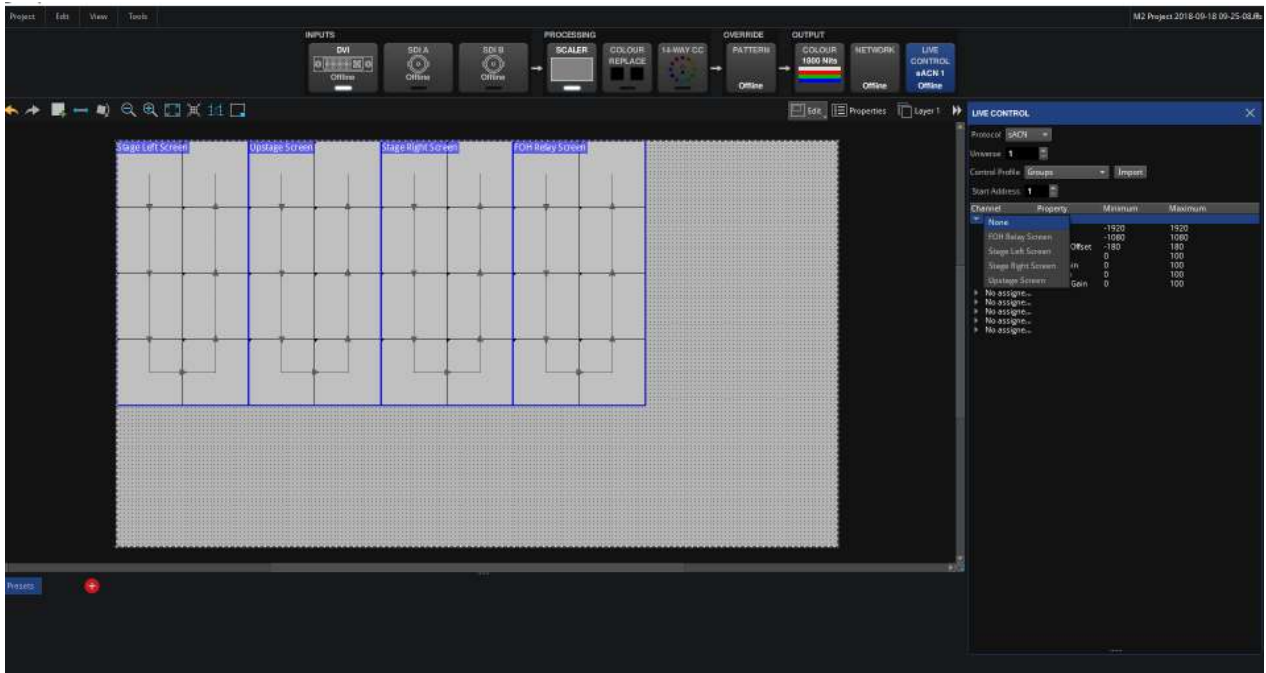

Figure 14-7. Configuring Fixture Groups

In the illustration above, the project includes 4 fixture groups. The user can assign each screen to a set of DMX channels and parameters that are controllable by their DMX, Art Net or sACN control device.

FOR INPUT CONTROL

In some profiles, the legend will reveal a drop-down menu for the video input selection. Using these controls, the parameters can be assigned to any bank of 10 channels.

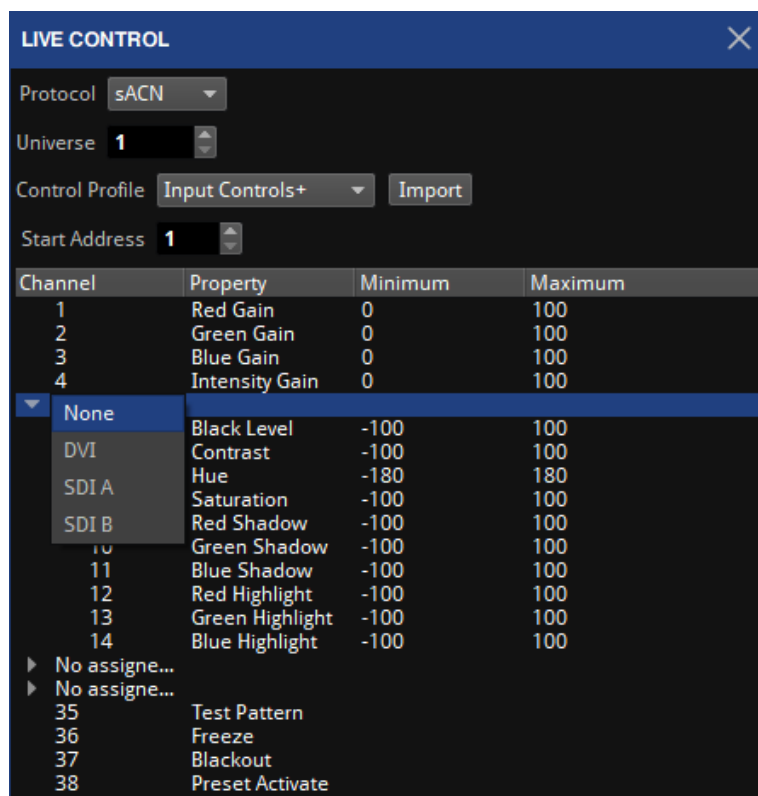

Figure 14-8. Configuring selected input parameters

MINIMUM AND MAXIMUM VALUES

Minimum and maximum values contained within control profiles parameters set the range of values achievable when controlled with live control. The parameter will be limited between the minimum and maximum values, with the DMX channel used to control the parameter being scaled between the two values.

This is useful in situations where it is important to limit the lowest or highest values of a parameter. An example would be limiting the Intensity gain of a processor to prevent panels being set to a brightness level that is undesirable.

DEFAULT VALUES

When working with parameters such as group position, once Live control is enabled, the location and orientation of the assigned group on the canvas will become the default location. Minimum and maximum values will be applied from the initial position on the canvas.

If live control is disabled and the assigned group is moved on the canvas, when re-enabling live control the new position of the group will become the default position. The minimum and maximum values will be applied from there.

Stored presets that place the group in one position on the canvas can now move to a different position. For consistent positioning in live control it is best not to move positions of groups once live control programming has begun.

Locking a single parameter on the processor to a value by setting both minimum and maximum values to the same value will prevent live control from changing this channel whilst allowing changes to be made to other parameters within the live control profile.

DMX CONTROL

CONFIGURING THE PROCESSOR FOR DMX CONTROL

1. Connect a source of DMX512 to the opto-isolated XLR 5 pin input.
2. Go to the Live Control pipeline tile and select DMX from the Control Protocol drop down menu.
3. Enter a Start Address for the processor. The Start Address will correspond with the DMX address of the first parameter in the selected Control Profile.
4. Enable Live Control by double-clicking the Live Control pipeline tile or enabling from the property editor.

If DMX is detected, the Live Control button will light up green to indicate that a source of Live Control has been detected and that Live Control is enabled.

EDMX CONTROL

CONFIGURING THE PROCESSOR FOR EDMX CONTROL

Both Art-Net and sACN (Streaming ACN aka E1.31) are supported.

1. Connect an eDMX source to the Net port on the processor's back panel (either directly or via switch).
2. Go to the Live Control pipeline tile and select Art-Net or sACN from the Control Protocol drop down menu.
3. Ensure that the processor is in an eDMX compliant IP Address and Subnet. This can be changed in the Setting – Processor menu. See "[Network](#)" on page [156](#) for more information.
4. Enter a Start Address and universe for the processor. The Start Address will correspond with the DMX address of the first parameter in the selected control profile and the universe will determine which eDMX universe the processor will listen to.
5. Enable Live Control by double-clicking the Live Control pipeline tile or enabling from the property editor.

If the eDMX signal is detected, the Live Control button will light up green to indicate that a source of Live Control has been detected and that Live Control is enabled.

Note - When connecting multiple processors to a single DMX over Ethernet source it is recommended to manage signal distribution with switches rather than using the second port as a through port to daisy-chained processors.

Note - When setting up Art-Net, the universe on Tessera processors start from 0 rather than 1.

TESSERA CONTROL

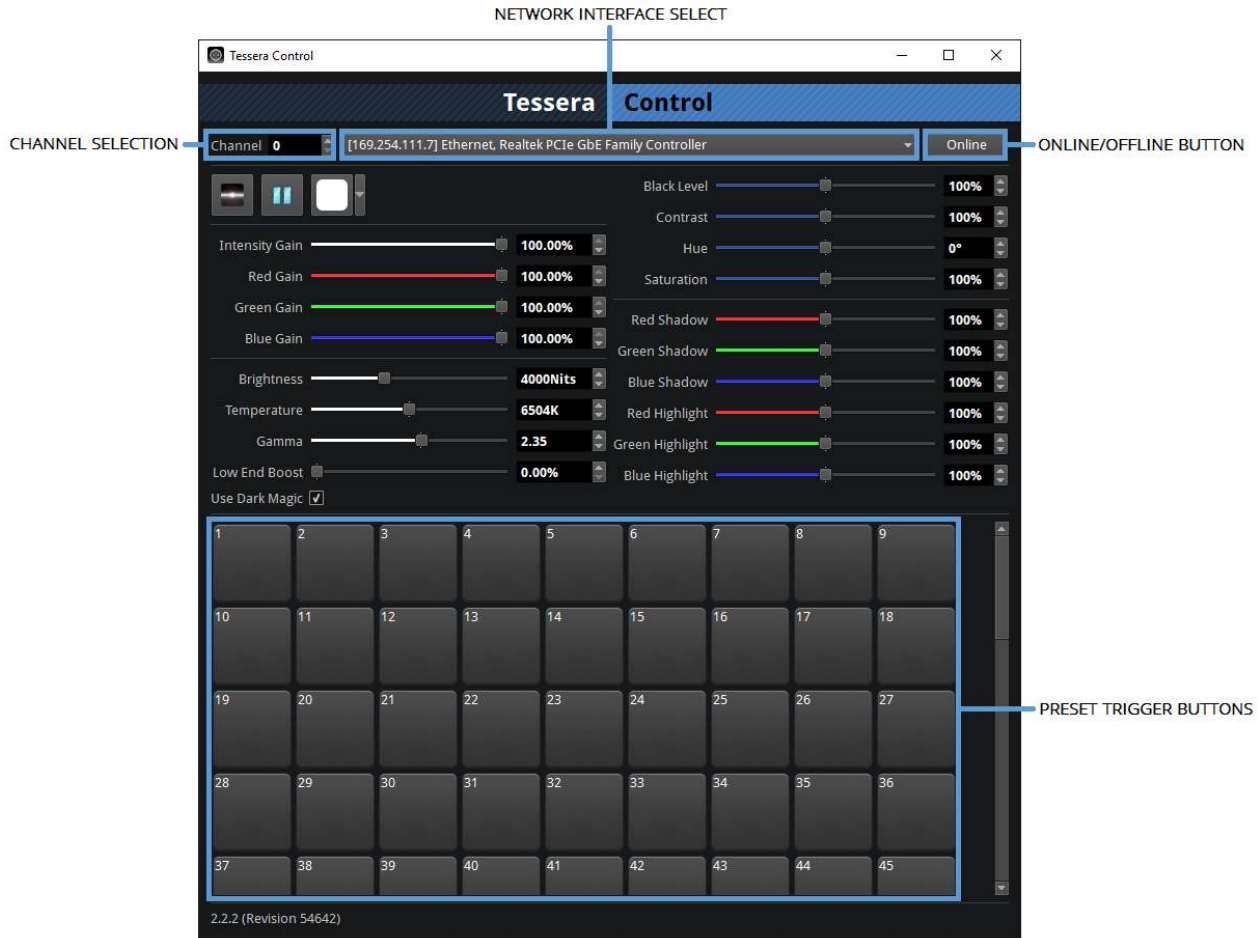

Figure 14-9. Control application GUI

1. Download and install the Tesseract Control application on a Windows or Mac computer.
2. Run the application and select the relevant Network Interface from the drop-down.
3. Connect the computer to the Net port on the processor's back panel (either directly or via switch).
4. Go to the Live Control property editor and select Tesseract Control from the Control Protocol drop down menu.
5. Choose a channel number and set this in both the Tesseract Control application and the Live Control property editor.

The channel number is used to determine which processors are controlled by which instances of the Tesseract Control application. By selecting the same channel number on multiple processors, they can be controlled simultaneously from a single instance of the Tesseract Control application.

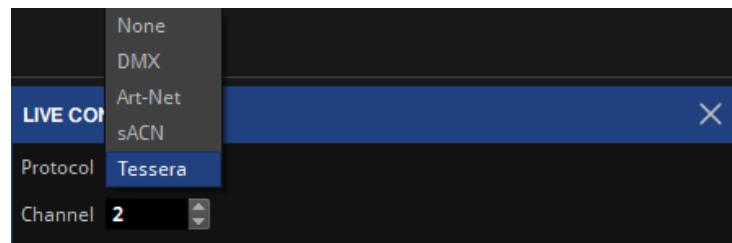

Figure 14-10. Selecting the Tesseract control protocol

6. Enable Live Control by double-clicking the Live Control pipeline tile or enabling from the Live Control property editor.
7. If the computer running Tesseract Control is detected, the Live Control button will light up green to indicate that a source of Live Control has been detected and that Live Control is enabled.

CHAPTER 15 - PROCESSOR SETTINGS

Access settings from the menu on the left of the Project Management Screen.

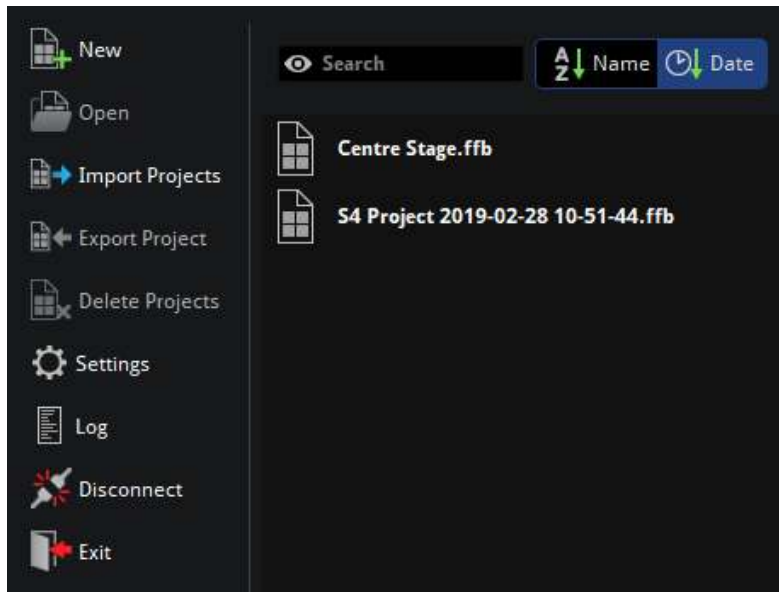

Figure 15-1. Project Management screen, select Settings from the left menu

If a project is open, choose Settings from the Tools menu of the Main Project Screen.

PROCESSOR

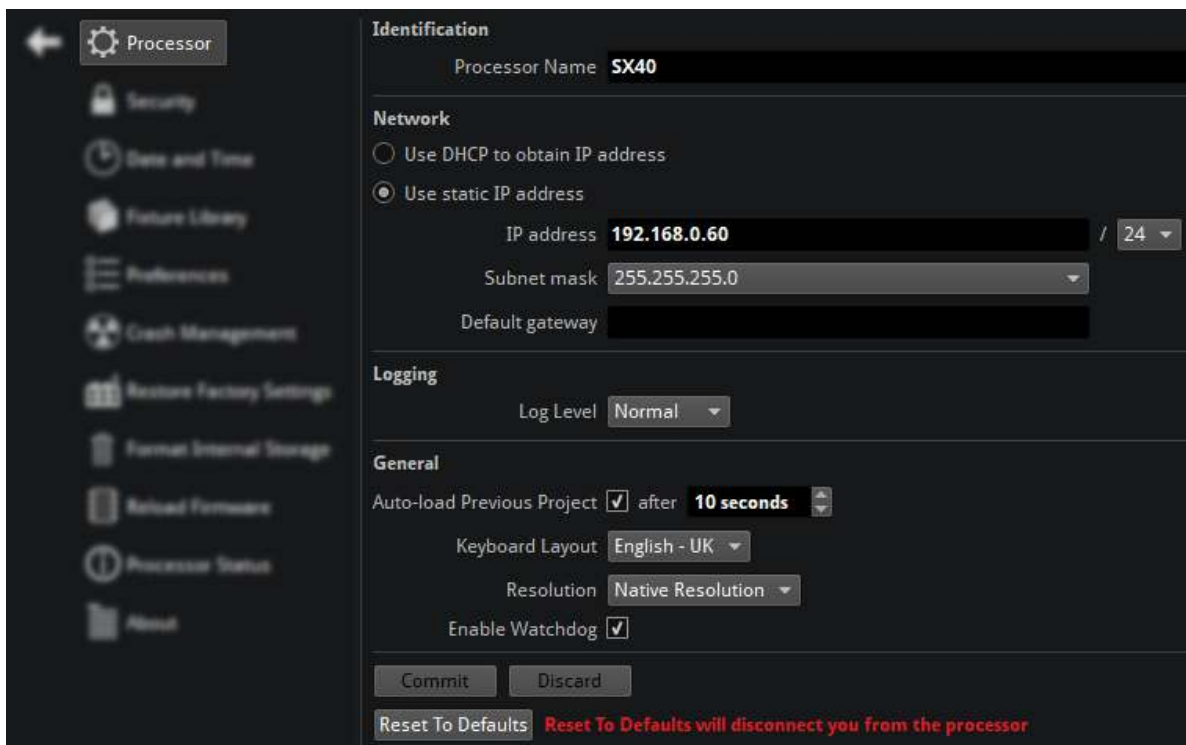

Figure 15-2. Processor Settings menu

Note - For any changes applied, the commit button needs to be clicked to save the modifications.

IDENTIFICATION

The name of the processor can be changed on the processor or when connecting to it remotely. This is useful when building a system that uses multiple processors. If no Processor name is defined, the processor will display its serial number in the Discovered Processors list in Tessera Remote and in the Remote windows title bar, for recognition when using several instances of the Tessera Remote.

NETWORK

The default IP address of a Tessera processors is 192.168.0.50 with subnet mask of 255.255.255.0.

The processor can be altered to a custom static address or set to receive an IP address from a DHCP server.

The gateway field allows the addition of an IP address from a network gateway such as a router.

For correct communication within a network between processors and/or remote computers, different IP addresses within the same IP range should be defined in each device.

GENERAL

Auto Load Previous Project

When the processor is switched on it will display the Start Screen with options to create new or open existing projects. A list of project files will appear in the order of last used and if no file is selected within 10 seconds, the processor will automatically load the previously opened file.

To disable the Auto load feature, untick Auto-load Previous Project. The time for a project to auto-load is also adjusted here.

Note - It is possible to change the autoloading countdown time to a value between 0-3600 seconds. For using this in a live situation, set this value to zero. In the event of a power cut the processor will reboot straight into the current project file with minimal delay.

Keyboard Layout

Different options can be selected to switch between languages that use different keyboard layouts.

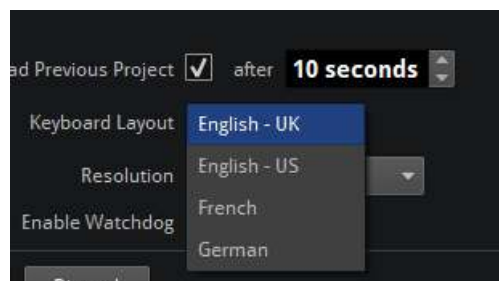

Figure 15-3. Keyboard Layout options

Resolution

Display resolutions for the monitor connected via DisplayPort to display the local UI can be changed. This value is set by default to read the native resolution from the connected monitor.

Note - This option doesn't affect the video input or output of the project.

Enable Watchdog

The watchdog is a hardware level process separated from the main processor which monitors and restarts if the processor stops responding, or in the event of a complete processor crash. If watchdog is disabled, the processor will remain in this state until it is manually rebooted. This may be desirable when seeking the cause of the issue. It is recommended to leave this option enabled, by default, watchdog is enabled to ensure processor uptime.

LIMITED SETTINGS WINDOWS

While in the Local UI and connected to a processor in the remote app, all the settings options are available. There are situations where the settings options may be limited.

Tessera Remote Offline Mode

When working in offline mode, there is a reduced number of settings available:

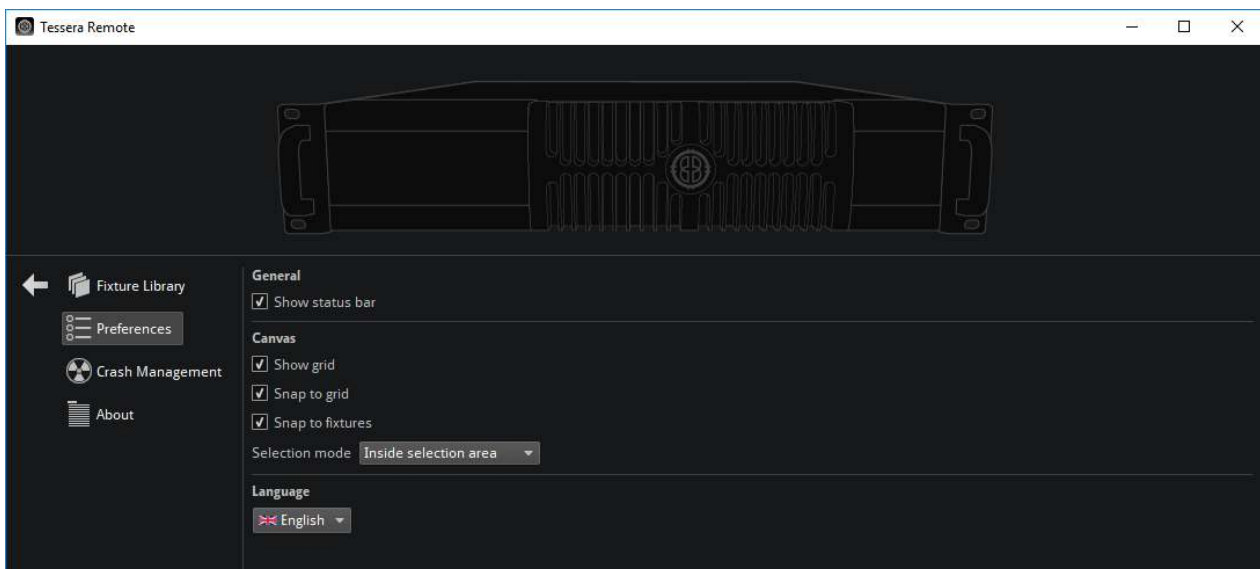

Figure 15-4. Processor settings while working in offline mode

Tessera Remote While Disconnected From Processor

When using Tessera Remote without connecting to a processor:

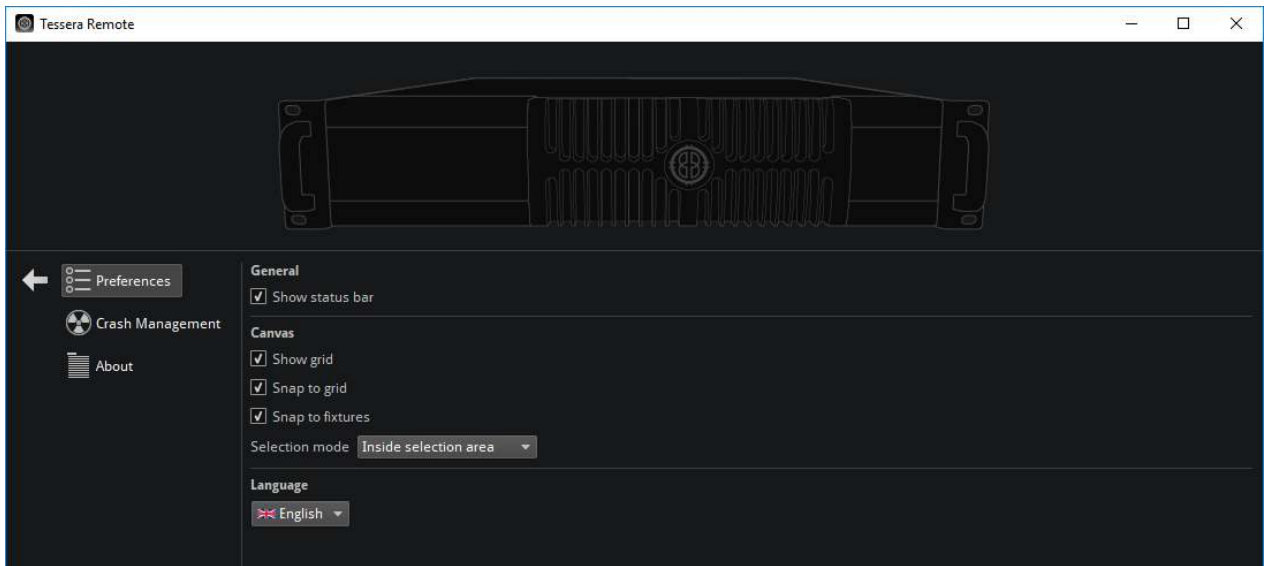

Figure 15-5. Processor settings when not connected to a processor using Tesseract Remote

SECURITY

A password can be applied to the processor. Each time a user connects to the processor via Tessler Remote application they will be prompted to enter the password. The password will be reset if factory settings are restored or it can be removed by re-entering the password in this window.

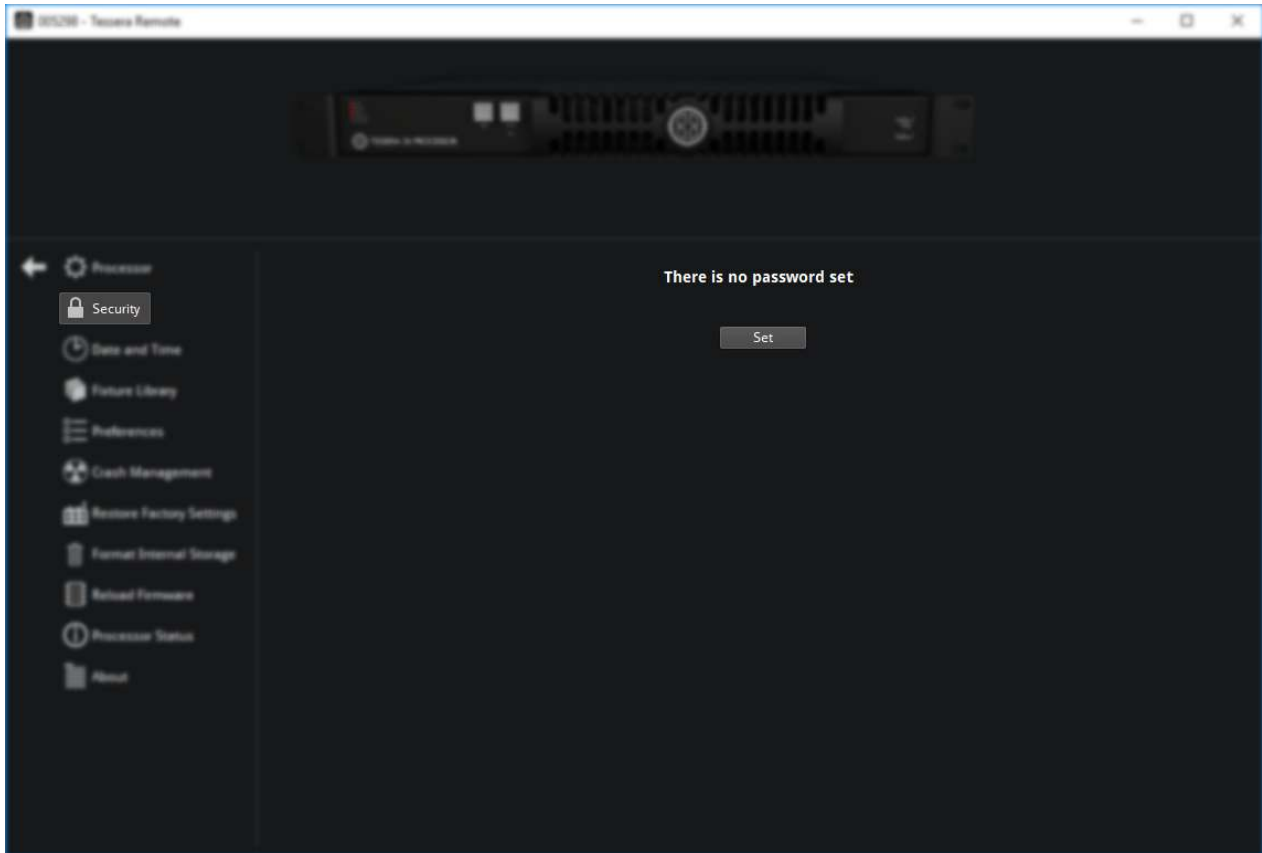

Figure 15-6. Security settings with no password set- the default setting

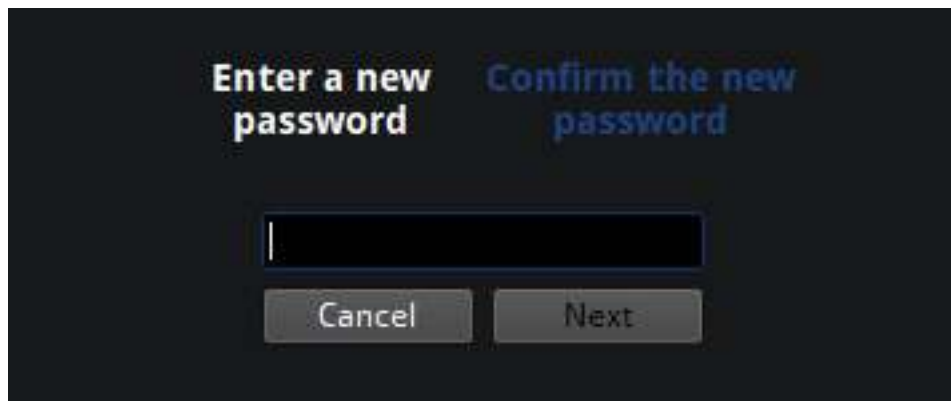

Figure 15-7. Setting a password

DATE AND TIME

A date and time can be applied to the processor, click on each value and use the keyboard to make modifications.

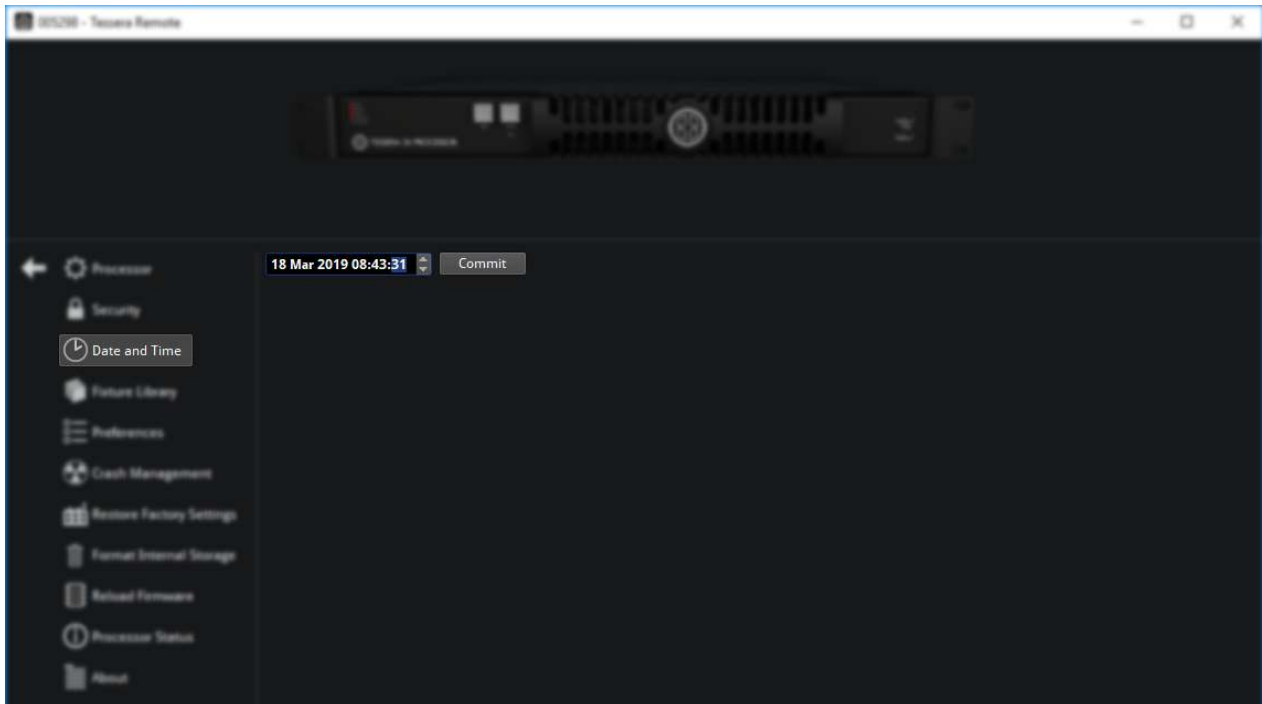

Figure 15-8. Tesseract Processor Date and Time settings

Note - The date and time are also used in log files and crash reports.

FIXTURE LIBRARY

To work with fixture packs, it is important to understand the meaning of some concepts:

Term	Description
Fixture firmware	(Included in a .tfd file) Software needed in the fixtures to be used and communicate with a processor.
Fixture personality	(Included in a .tfd file) Software needed in the processor to recognize the fixtures properties.
Fixture pack	(.tfp) Compilation of fixture firmware. The public releases will include all the updated public fixtures to the date of release.
Fixture library	Group of fixture packs installed in a processor.

All processor firmware releases contain the latest Tessera fixture pack at the time of the release. In most cases, using the latest processor firmware release is enough to ensure support for all known panel types.

Check Brompton Technology's website for the latest firmware and fixture updates:
<https://www.bromptontech.com/support>

In situations where a new fixture type becomes available or when an urgent fix is required for an existing fixture, Brompton may release a Tessera Fixture Pack (.tfp file) containing the updated list of fixture firmware.

The list of fixture personalities and its firmware version loaded into the processor is detailed in the Fixture Library.

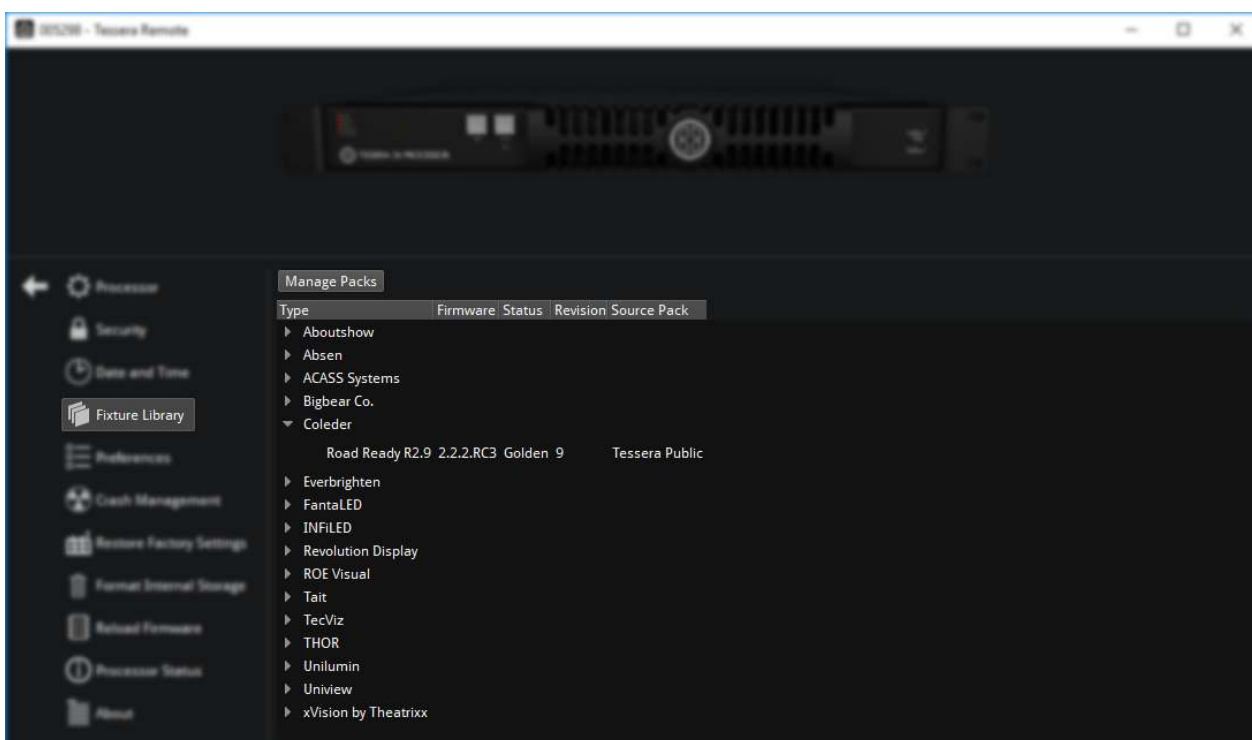

Figure 15-9. Fixture Library in processor settings

PACK PRIORITY

To update fixture packs, click Manage Packs. Packs listed here are loaded in descending order with highest priority at the top of the list. The priority can be changed by dragging the desired fixture pack above another pack containing the same fixture type.

If a fixture exists in multiple packs, by default the version in the highest priority pack (higher in the list) is used and the same fixture will appear greyed out in lower priority packs.

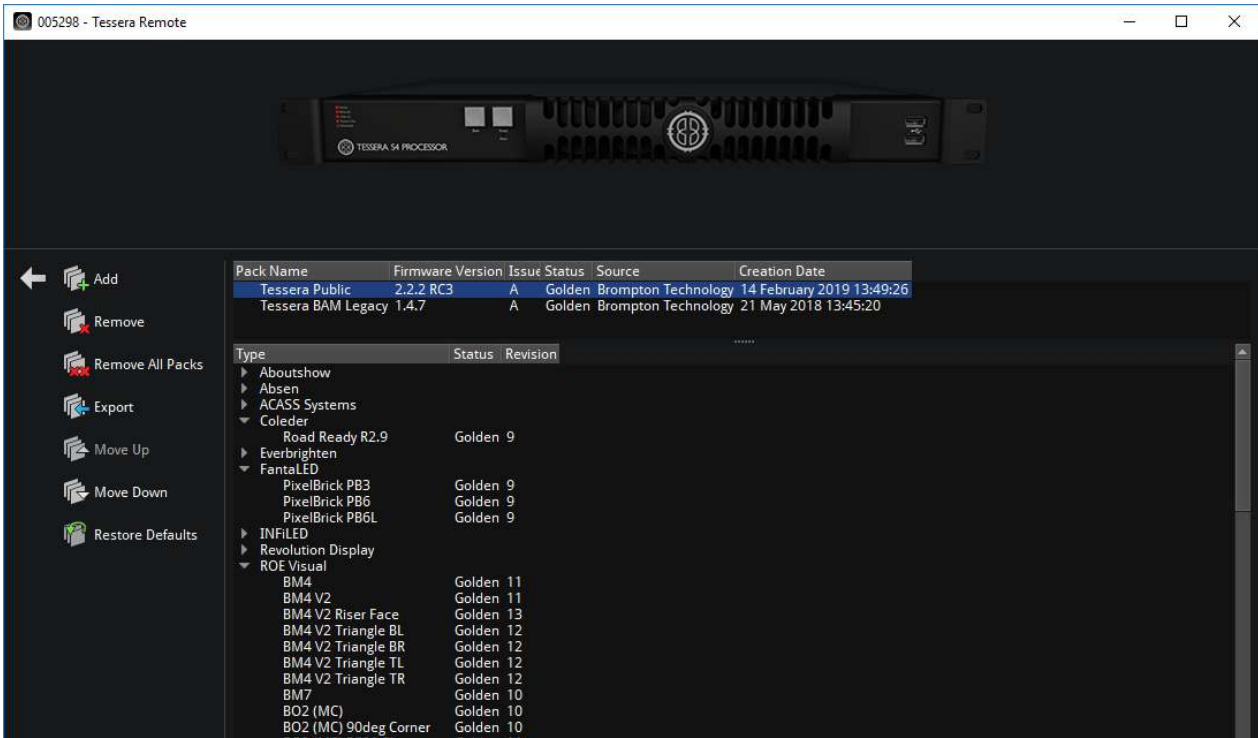

Figure 15-10. All fixture firmware contained in a fixture pack is shown in Manage Packs

The new priority will take effect immediately for selected fixture firmware versions and the project will ask to update the firmware in the fixtures with the error “XX detected devices are not running the specified firmware version”.



Figure 15-11. Error message notification shown when detected fixtures are running incorrect firmware versions

OVERRIDE PRIORITY

The priority order can be overridden so a selected fixture can use the firmware from a different fixture pack than the one with the highest priority. To change priority, select a pack then click Move Up or Move Down. Fixture packs at the top has priority over packs below.

In the fixture library, select the fixture personality whose priority needs to be modified. At the bottom of the page, the source pack dropdown menu will show all the fixture packs installed in the processor.

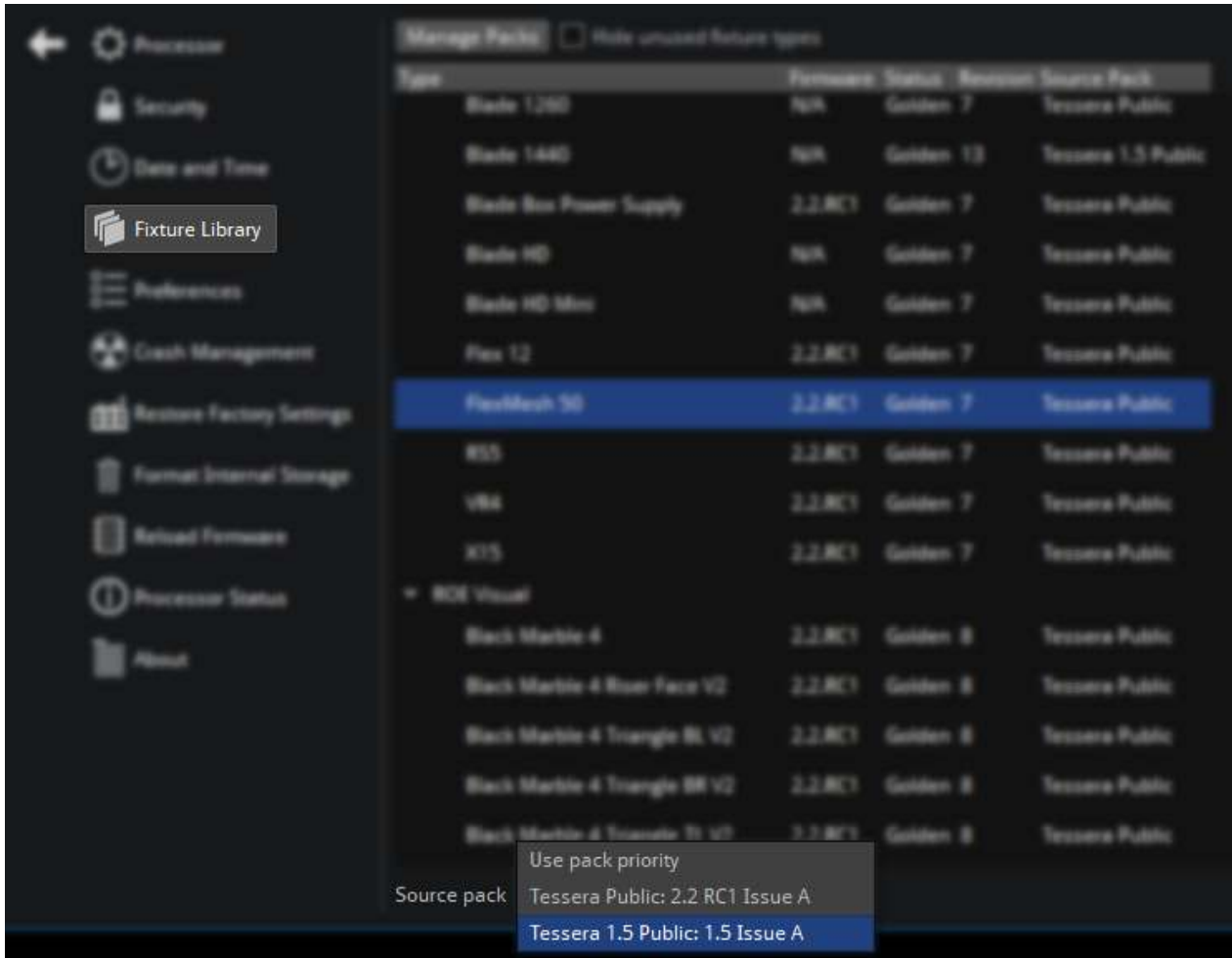

Figure 15-12. Overriding priority by selecting source packs to use for a specific fixture

Select the fixture pack containing the desired fixture firmware and it will be automatically set as the default pack for that fixture.

PROJECT FIXTURES

To display only the fixtures being used in the project that is open, check the tick box Hide unused fixture types.

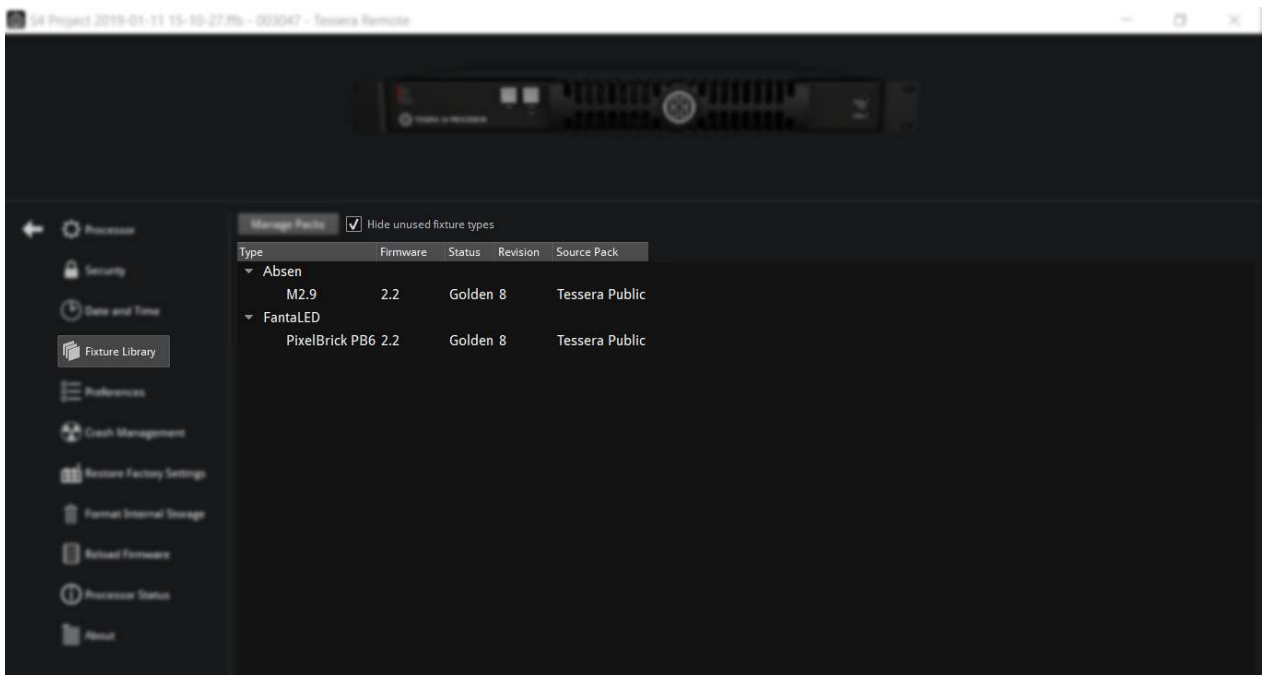

Figure 15-13. Filtering the fixture library to only show fixtures used within the current project.

TRANSFERRING PACKS

Fixture packs can be transferred between processors using the Export option. All user-imported packs can be deleted by selecting Restore Defaults. Packs can be also selected and deleted using the Remove and Remove all options.

Click the Back button to return to the fixture library, which now displays the revision of each fixture personality, its release status and the source pack providing it.

ADDING AND REMOVING PACKS

To import a new fixture pack, click Manage Packs and click Add. Select the location where the pack is stored. Select the fixture pack and press open to load it into the processor.



Figure 15-14. Adding a fixture pack

To remove a pack, first select it from the list then click Remove. The user will be prompted that removing a pack will delete it permanently from the processor and also to confirm or cancel the action.

Remove all packs will remove all currently installed fixture packs on the processor. The user will be prompted to confirm this action before proceeding.

Built-in fixture firmware packs can be restored by using the Restore Defaults option. Any user installed packs are not included.

PREFERENCES

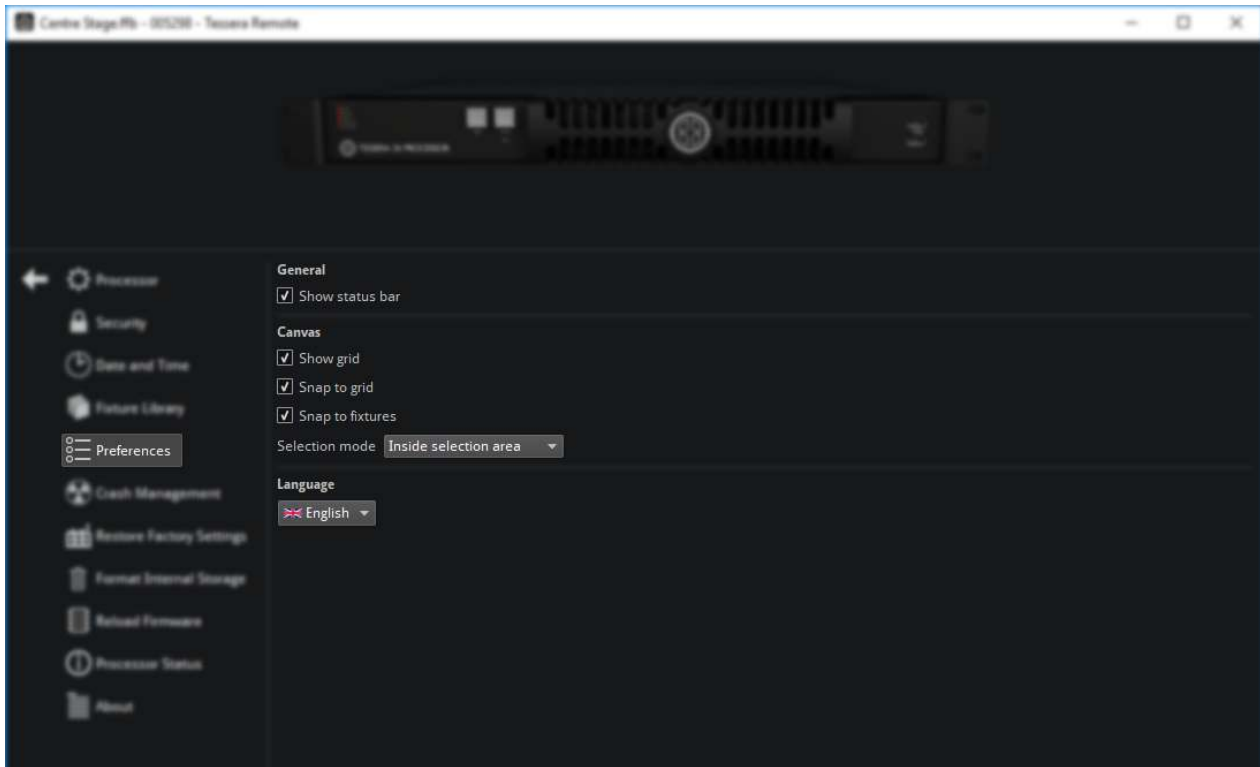

Figure 15-15. Preferences menu

GENERAL

The status bar is located on the bottom of the Project Canvas. It provides helpful tips and information of where the mouse cursor is located. Unticking the option in the preferences menu hides the bar.



Figure 15-16. The status bar is located at the bottom of the user interface

CANVAS

This section contains settings to help with selecting and aligning fixtures on the canvas.

Show Grid	Grid dots can be shown or hidden at convenience.
Snap to Grid	Pull fixtures into perfect alignment with the grid. Is enabled by default, helping to align or space fixtures evenly on the canvas.
Snap to Fixtures	Pull fixtures into perfect alignment with other fixtures. Is enabled by default helping to align fixtures evenly on the canvas avoiding overlapping or small gaps.

Selection Mode

Selection modes alter the behaviour for dragging a selection box around fixtures on Canvas View. To change Selection Mode, navigate to Settings > Preferences.

Inside selection area	The selection area must completely enclose fixtures to select them.
Overlaps selection area	A fixture will be selected if any part of the fixture is within the selection area.
Drag direction mode	Dragging from left to right selects only fixtures that are entirely inside the selection box.
	Dragging right to left selects all fixtures that are at least partially inside the selection area.

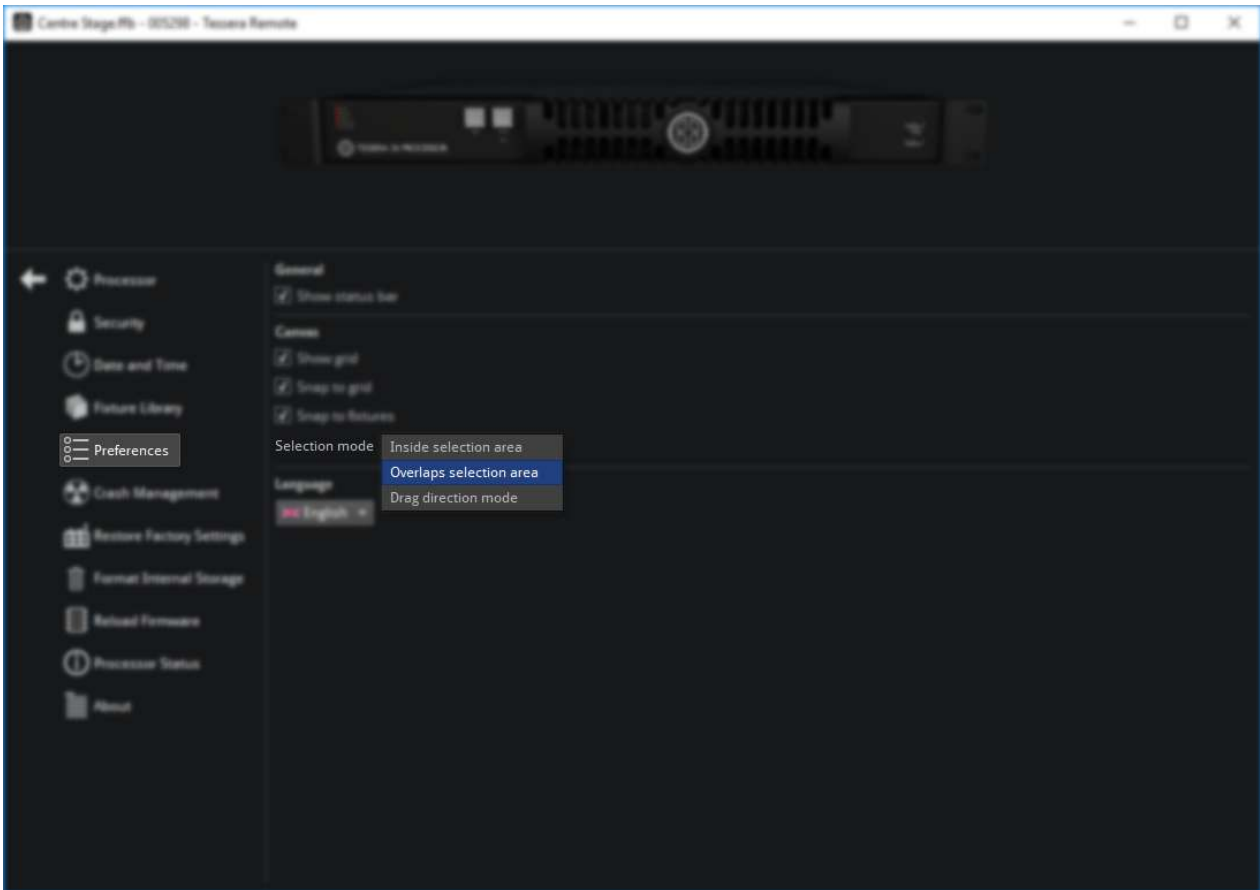

Figure 15-17. Selection mode as shown in the Preferences menu

LANGUAGE

Language settings have been added to the processor and Tessera Remote application. Current options allow the interface language to be set to English or Chinese.

CRASH MANAGEMENT

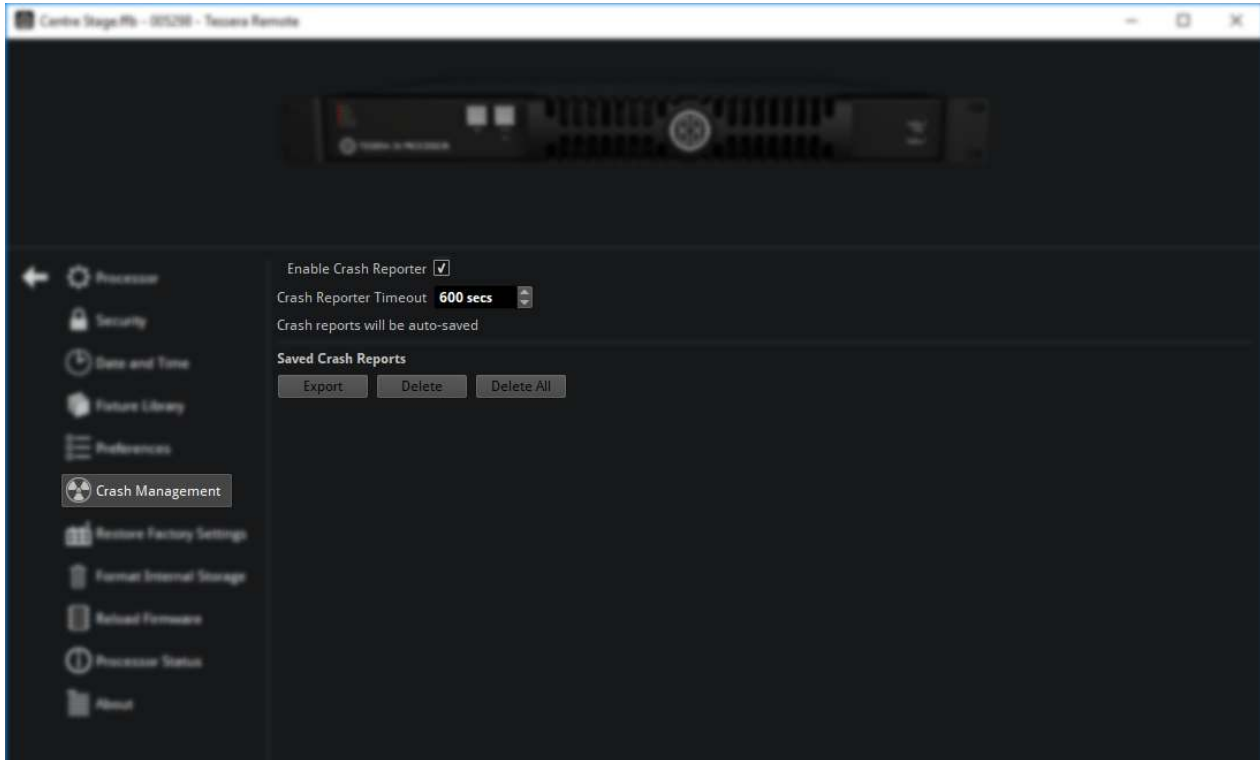

Figure 15-18. Crash Management options in Processor Settings

The processor will pause after a crash before rebooting to allow time for the user to enter information about what actions were performed before the crash. The time duration of this pause can be set to unlimited or between 0 and 3600 seconds. The saved crash reports can then be exported to a USB storage. The crash reporter is set to on by default but can be disabled.

RESTORE FACTORY SETTINGS

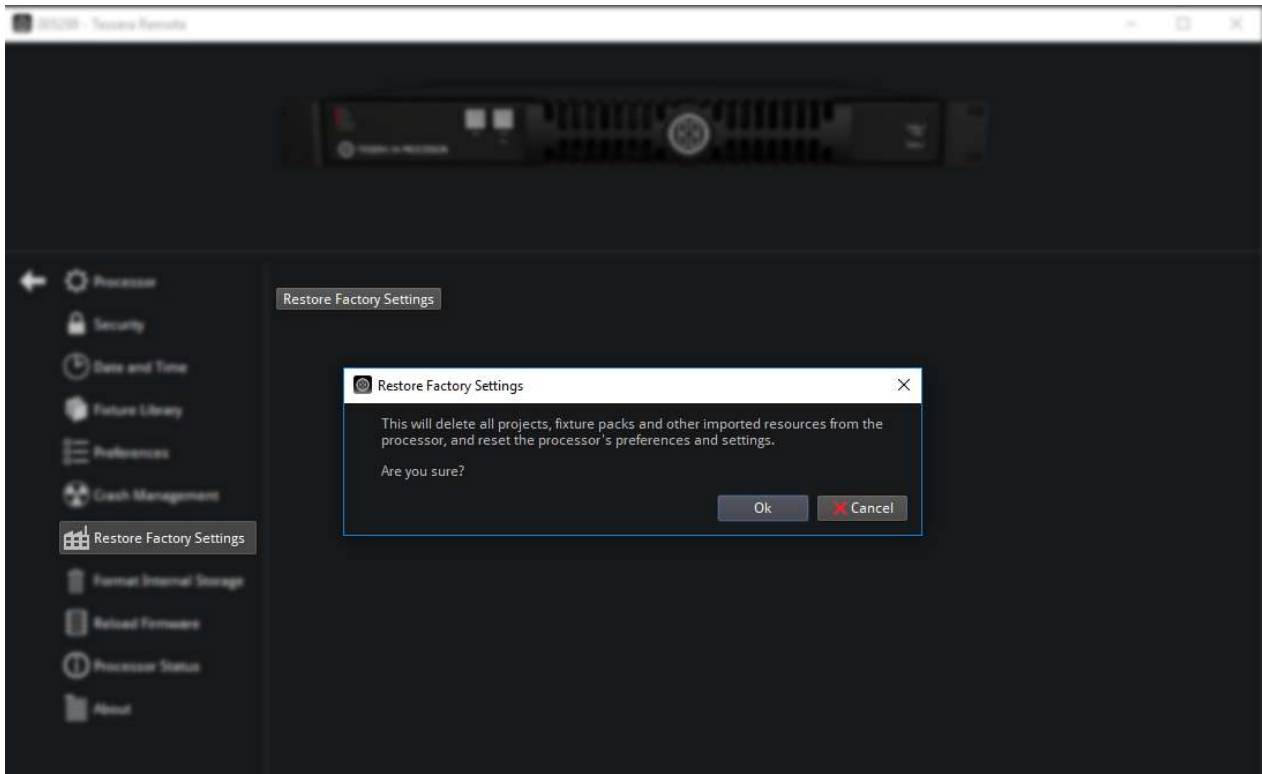

Figure 15-19. Restore factory settings, with warning prompt before restoring.

Restoring the processor to factory settings will remove all user defined characteristics of the processor and revert all settings back to default. Project files, any imported fixture definition files and fixture firmware not included in the current software release will also be removed. Project files must also be closed before proceeding.

Factory settings can also be restored by pressing and holding the front reset button of the processor for 10 seconds. See ["Front Panel"](#) on page 7 for more information.

FORMAT INTERNAL STORAGE

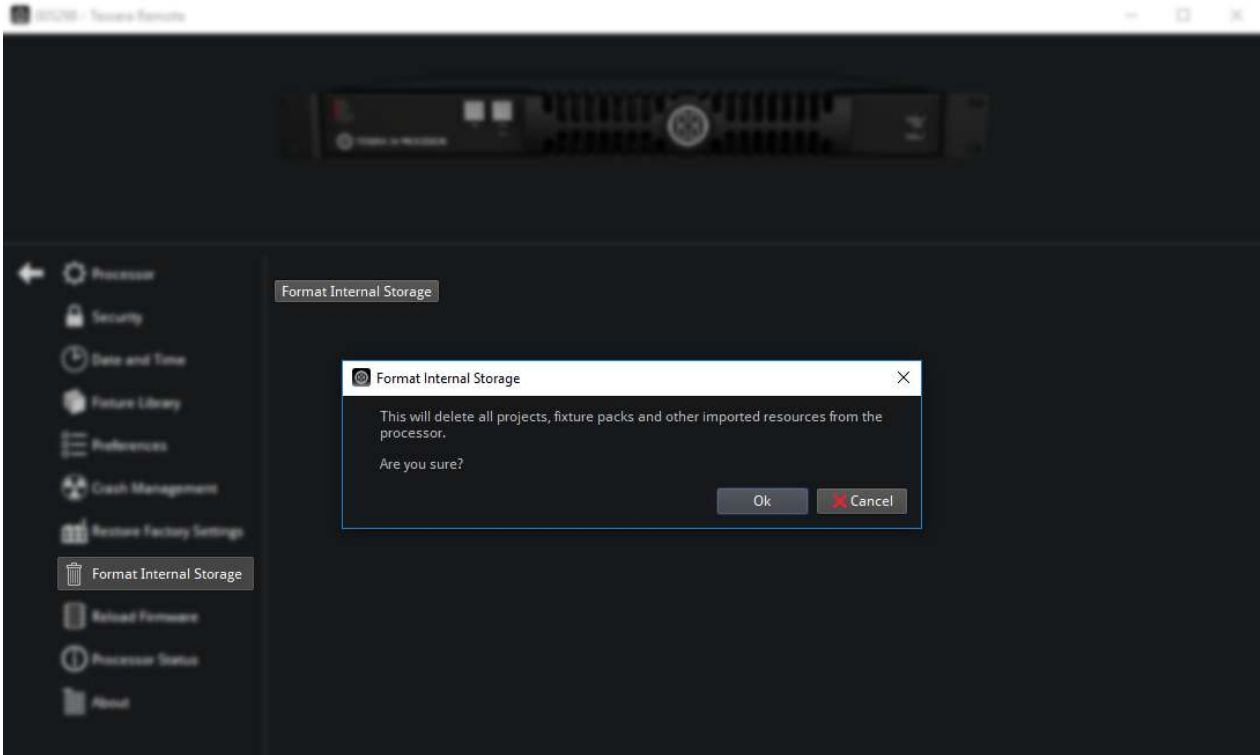

Figure 15-20. Format internal storage menu, displaying warning notification before formatting

Formatting internal storage will clear the memory of the processor. This will delete all project files, any imported fixture definition files and fixture firmware not included in the current software release. The current software version of the processor will be retained after an internal storage format has been performed.

RELOAD FIRMWARE

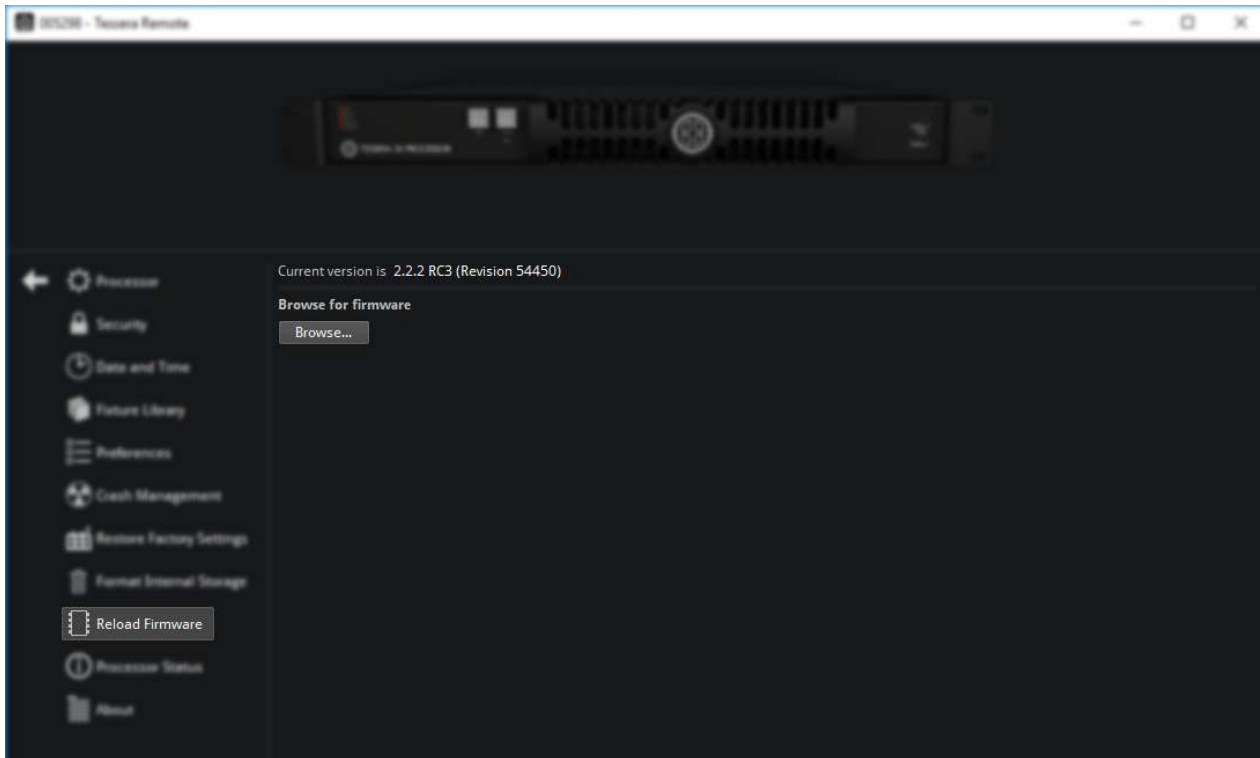

Figure 15-21. Processor settings, reload firmware menu

The reload firmware option allows the user to change the software running on the processor. Any firmware builds can be uploaded to the processor and stored in internal flash memory, if the user chooses to do so. The stored file list may contain older or newer builds under the heading Choose from existing.

If a suitable build is unavailable, it can be added from USB storage or from the storage of a computer running Tesseract Remote. To do this click Browse and navigate to the location where the firmware is stored.

A dialog box with the heading 'Reload Firmware' is displayed for the user to confirm selection.

Clicking 'Yes' will reload the firmware and save a copy to the local storage. The firmware can now be accessed from the Reload Firmware page.

Reloading firmware with Tesseract remote is similar but the user accesses the file for reloading from the remotely connected computer instead of from USB storage.

The latest and previous processor software releases can be found on our web site:
www.bromptontech.com/support

Once the firmware update is complete, the processor will rebooting and return to the Project management screen in the new firmware version. Existing project files and additional fixture definition files will remain. It is best practice to export copies of important project files before a firmware upgrade.

Note - Newer firmware versions are backwards compatible with older versions of firmware. However new projects created on newer versions of firmware will not normally work on older versions.

PROCESSOR STATUS

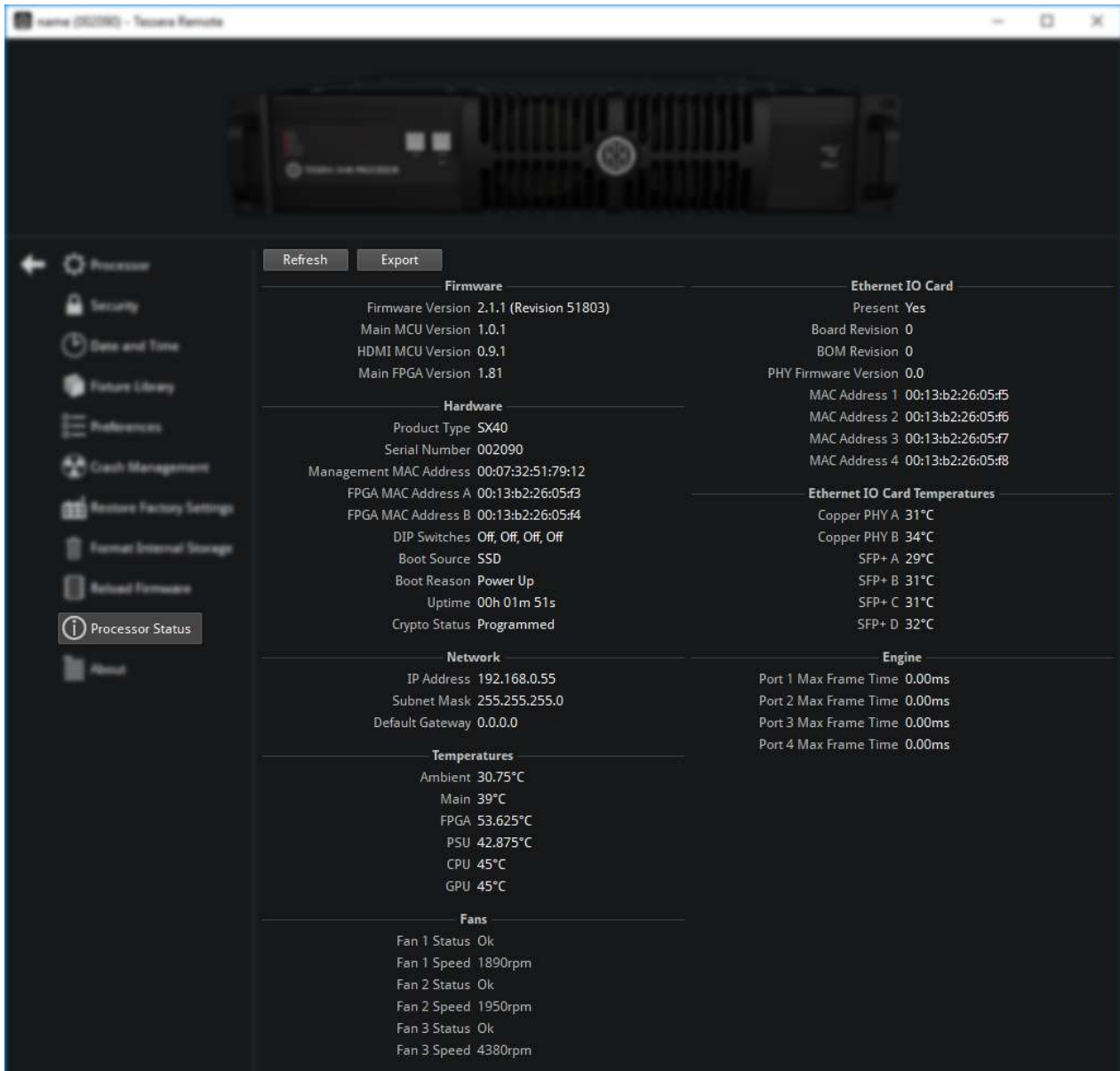

Figure 15-22. Processor status

The processor status window gives information on the current setup and the condition of the processor. This ranges from details of the current software and hardware setup to data about the temperature, network settings and revision numbers of processor components.

Processor status information can be exported to USB storage by clicking on the Export button at the top of the page. Confirm the save location. The default name file name is set to "xxxx_state.xml", where xxxx is the processor serial number. The serial number may be requested upon contacting Brompton support.

ABOUT

The About window contains information regarding software or firmware version currently in use, the end user license agreement between Brompton and the user, third party license agreements relevant to the software and the Brompton contact details including company address and the support email address: support@bromptontech.com

APPENDIX A - KEYBOARD SHORTCUTS

GLOBAL

Ctrl + Z	Undo
Ctrl + Shift + Z or Ctrl + Y	Redo
Delete or Backspace	Delete selected fixtures or groups
Esc	End current task
Ctrl + I	Show properties for selected fixtures or groups (or for canvas if there is no selection)
While moving a slider, hold Alt	It will not snap to default value
F1	Go to Edit mode
F2	Go to Rear Edit mode
F3	Go to Video Only preview (Tessera processor only)
F4	Go to Video on Fixtures preview (Tessera processor only)
F5	Go to Video on Fixtures Only preview (Tessera processor only)
F6	Heat map
F11	Fullscreen (Tessera Remote and Offline Editor only)

CANVAS

Ctrl + G	Group
Ctrl + Shift + G	Ungroup
Ctrl + left-click on a fixture	Toggles its selection
Double left-click on a fixture	Select whole string
Shift + left-click on a group	Select individual fixture in a group
Ctrl + drag	Create duplicates of the selected fixtures or groups
Tab	Select next fixture on string
Shift+Tab	Select previous fixture on string
Up/Down/Left/Right Arrow	Nudge selected fixtures or groups by grid spacing
Shift + Up/Down/Left/Right Arrow	Nudge selected fixtures or groups by one pixel
Ctrl+F	Fit to screen
Space + Drag	Scrolls around canvas
Ctrl + Alt + 0-9	Select OSD page for selected panels
Ctrl + Alt + Up or Down	Change OSD font size.

WHILE ADDING FIXTURES

Shift + left click	Add a new fixture and join it to the last added fixture
Left-click and drag	Create an array of fixtures
Alt + wheel	Set angle of new fixture
While moving fixtures or an array, hold Alt	Invert snapping behaviour
While resizing active area corner, hold Ctrl	Unlock aspect ratio
While resizing active area, hold Alt	Invert snapping behaviour
Ctrl + +	Zoom In
Ctrl + -	Zoom Out
Ctrl + 0	Zoom 1:1
Ctrl + wheel	Zoom in and out
Middle-click and drag	Zoom to the dragged rectangle
Space + drag	Pan the view

OSCA



Ctrl + Shift + O	Enter OSCA
F1/F2/F3/F4/F5/F6	Seam type
F7	Module selection
F8	Panel selection
A/S/D/F/G/H/J	Display colour
Space	Toggle to the next display colour (to the right)
Ctrl + Space	Toggle to the previous display colour (to the left)
Tab	Toggle to video input

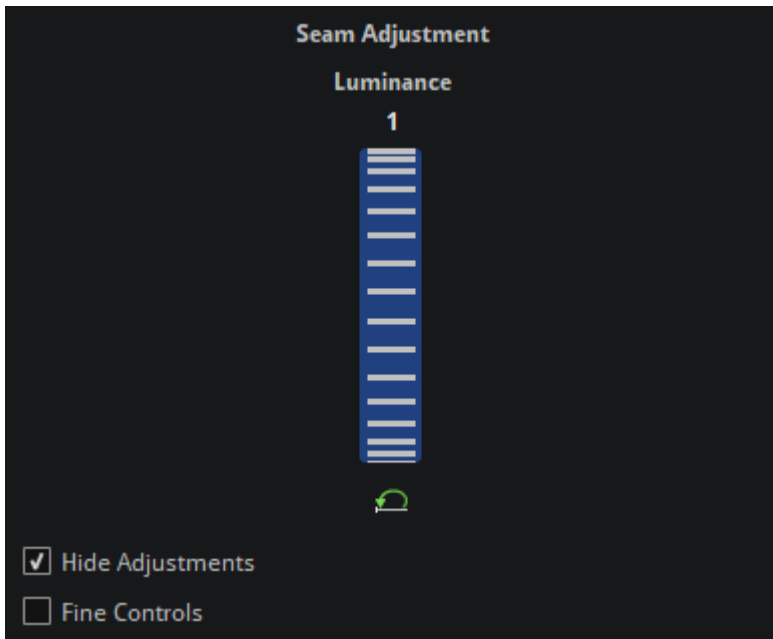

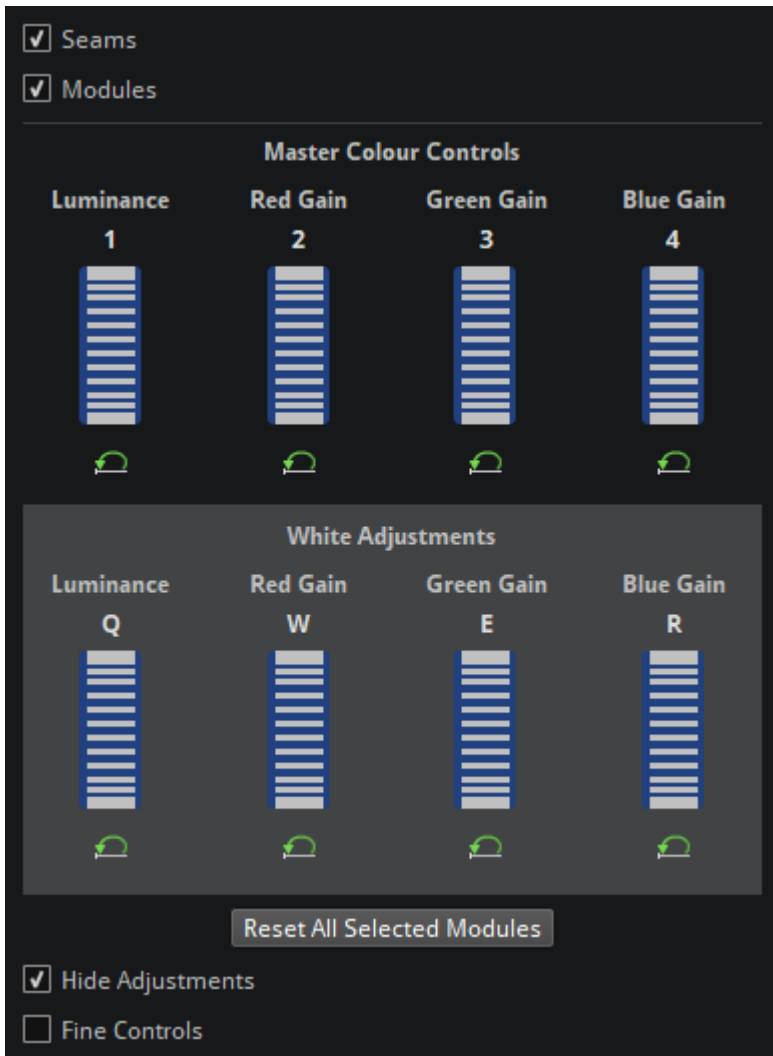

1 + Up/Down arrow	Luminance - Master Control
2 + Up/Down arrow	Red Gain - Master Control
3 + Up/Down arrow	Green Gain - Master Control
4 + Up/Down arrow	Blue Gain - Master Control
Q/W/E/R + Up/Down arrow	Colour value adjustment

APPENDIX B - CABLE REQUIREMENTS FOR TESSERA SX40 AND XD

TESSERA SX40 AND XD CABLE REQUIREMENTS

The Tessera SX40 LED processor and XD distribution boxes may be connected by either copper or fibre cables. Each port independently auto-switches between copper and fibre according to the type of cable connected. A mixture of copper and fibre may be used within a single installation (for example, copper for shorter links and fibre for longer ones).

Fibre cables are typically preferable to copper cables, due to their ability to operate over longer distances, their immunity to environmental electrical noise, and their electrical isolation of the connected devices. However, copper cables are typically more widely available, lower cost and easier to terminate, so may be preferred in some situations.

FIBRE

For fibre connections, Tessera SX40 and XD feature opticalCON DUO connectors. These support single-mode fibre cables terminated with the following connectors:

- Neutrik opticalCON DUO ARMORED (PC)
- Neutrik opticalCON DUO X-TREME (PC)
- Neutrik opticalCON DUO (PC)
- Neutrik opticalCON DUO LITE (PC)
- Generic LC Duplex (PC)

Fibre cables must be single-mode fibre, 1310nm, 9/125 µm, with PC or UPC connectors. Multi-mode fibre is not supported, nor are APC connectors. Plugging APC connectors into Tessera SX40 and XD must be avoided as this may cause damage to the connectors.

Tessera SX40 and XD have been tested with fibre cables up to 2KM in length. Longer distances (up to 10KM) may be achievable, but have not been tested by Brompton Technology.

COPPER

For copper connections, Tessera SX40 and XD feature Neutrik Cat6A etherCON connectors. These support cables terminated with the following connectors:

- Neutrik etherCON CAT6A
- Neutrik etherCON (CAT5e)
- Generic Cat6A RJ45
- Generic Cat5e RJ45

Copper cables may consist of:

- Cat6A (typically up to 60 metres)
- Cat5e (typically up to 30 metres)

The cable type (Cat5e or Cat6A) must be terminated with the correct connector type, so a Cat6A cable should be terminated with a Cat6A connector whereas Cat5e only needs to be terminated with a Cat5e connector.

Cable lengths have been tested using Belden 1302E CatSnake S/FTP Cat6A and Belden 1305A CatSnake UTP Cat5e, but other types of Cat6A and Cat5e compliant cable may be used. Cable lengths are provided as an indication only for the above Belden cables, as the maximum achievable distance will be dependent on the quality and condition of the cable, the quality of the terminations at both ends, and the electrical environment in which the cable is used. Cat6A should generally be used in preference to Cat5e where possible. Cat7 or higher may also be used, but has not been tested by Brompton Technology.

Shielded cables will typically provide better immunity from external electrical interference. The shield must be electrically connected at both ends of the cable to ensure correct operation. As a side-effect of this, the earths of the devices at each end of the cable will be connected via the cable's shield. Care must therefore be taken to

ensure both devices are at the same earth potential when using shielded cables, otherwise data corruption or potentially severe damage to the cable or connected devices may occur.

If earth potentials cannot be guaranteed, we recommend the use of unshielded copper cable (for shorter distances in quiet electrical environments) or fibre (for longer distances or noisy electrical environments), as these both maintain electrical isolation between the connected devices.

10G ETHERNET COMPATIBILITY

The use of third-party 10G Ethernet media converters for conversion between copper and fibre formats is discouraged, and should be unnecessary as both Tessera SX40 and XD support both copper and fibre natively. Similarly, the use of third-party 10G Ethernet 'repeaters' (to extend cable lengths) is discouraged. Brompton Technology does not test for correct system operation with the use of third-party media converters or repeaters.

Where it is necessary to convert between fibre and copper, or to 'repeat' a signal for longer transmission distances, a Brompton Technology XD may be used to achieve this. Up to five XDs may be daisy-chained together as required to achieve any necessary signal conversion or repetition.

The use of 10G Ethernet switches is not supported, as these can disrupt the extremely high-bandwidth data flows in unpredictable ways, resulting in intermittent system failures. In addition, 'splitting' 10G Ethernet feeds using switches is not supported. Instead, multiple outputs on the Tessera SX40 should be used, or alternatively up to five XDs may be daisy-chained together as required to achieve outputs to panels at multiple locations.

APPENDIX C - SETTING IP ADDRESSES

SETTING THE IP ADDRESS ON WINDOWS SYSTEMS

1. On older versions of Windows, click on the start menu and select Control Panel > Network and Internet > Network Connections. Select the network adapter corresponding to the Tessera processor.
2. For Windows 8 and above, click on the start menu and type: control panel, select it from the list, then open Network and Sharing Centre. In the left menu, select Change adapter settings and from the list of connections select the network adapter used to connect to the Tessera processor.

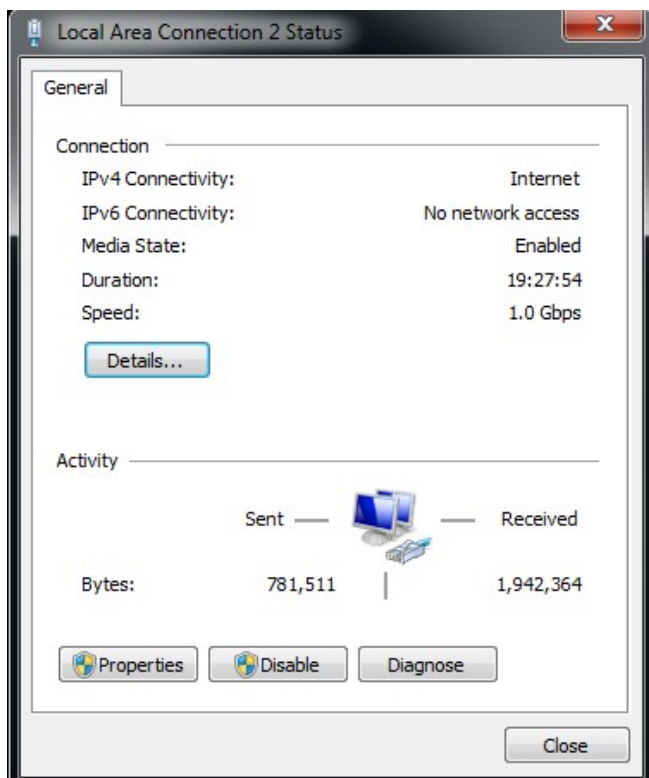

3. Select Properties and double-click on Internet Protocol Version 4 (TCP/IPv4)

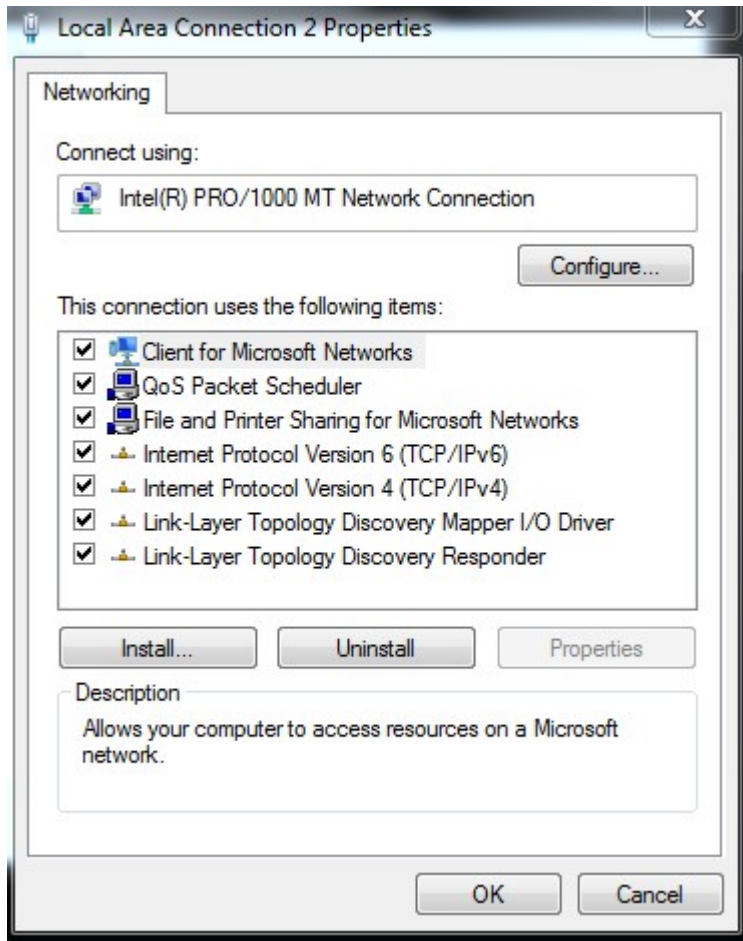

4. Click on Use the following IP address to manually enter an IP address. Given that the default IP address of a Tessera processor is 192.168.0.50 in a subnet mask 255.255.255.0, choose an IP address that isn't already taken within the 192.168.0.x range, where x is a number between 1 and 254, except for 50.

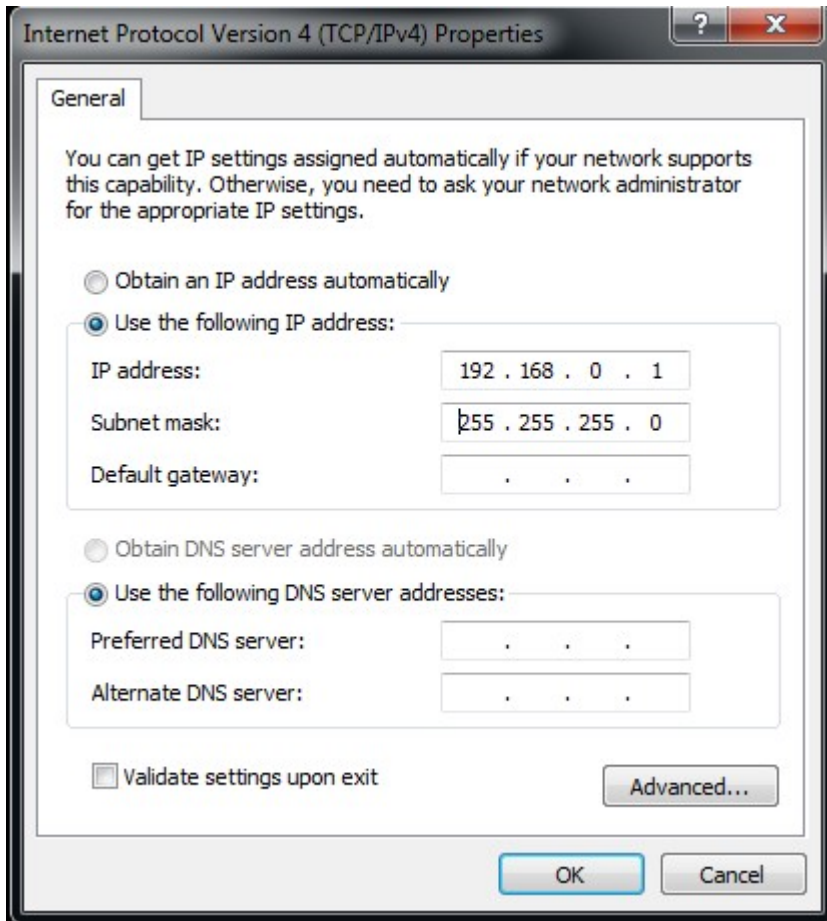

5. Click OK to confirm settings and the computer is now be ready to connect to a Tessera processor.

SETTING THE IP ADDRESS IN MAC OS X

Current Mac computers do not feature a wired Ethernet network interface. To connect to a Tessera processor without using a WLAN requires either a USB, Thunderbolt or USB-C Gigabit Ethernet adapter. All of which are available from Apple or third-party suppliers.

1. Click the Apple symbol in the top left corner of the main screen. Select System Preferences and click on the Network icon.

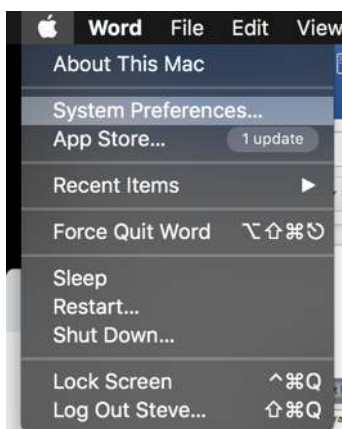

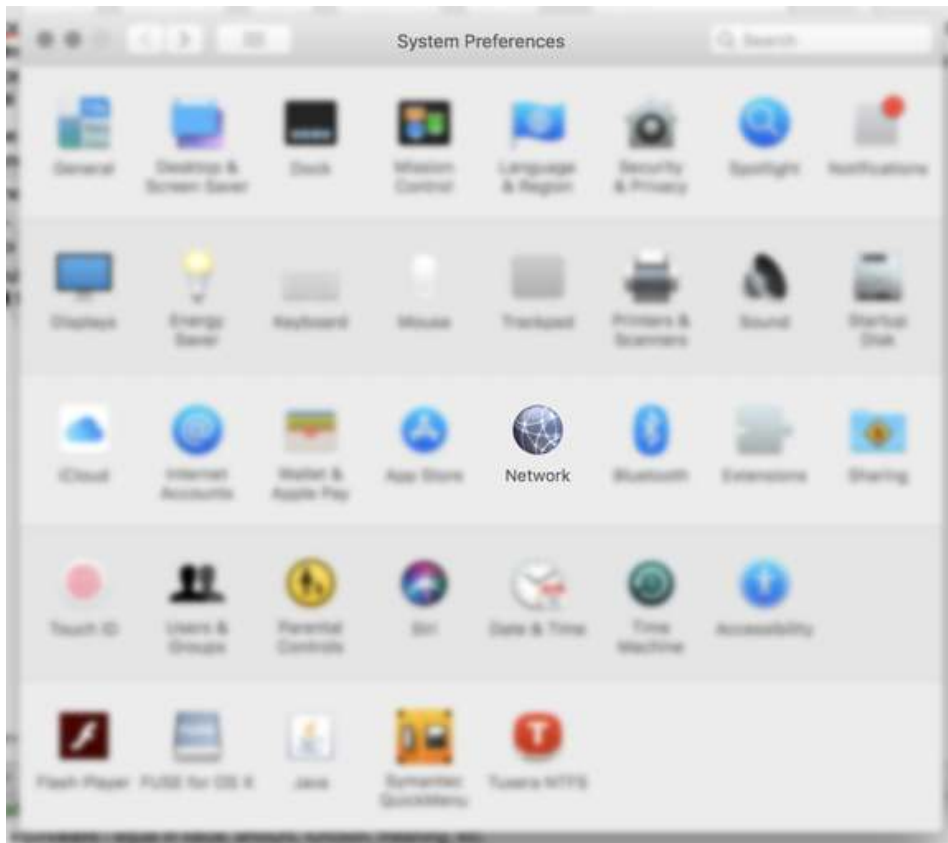

2. Open the Configure IPv4 dropdown menu and select Manual from the list of options.

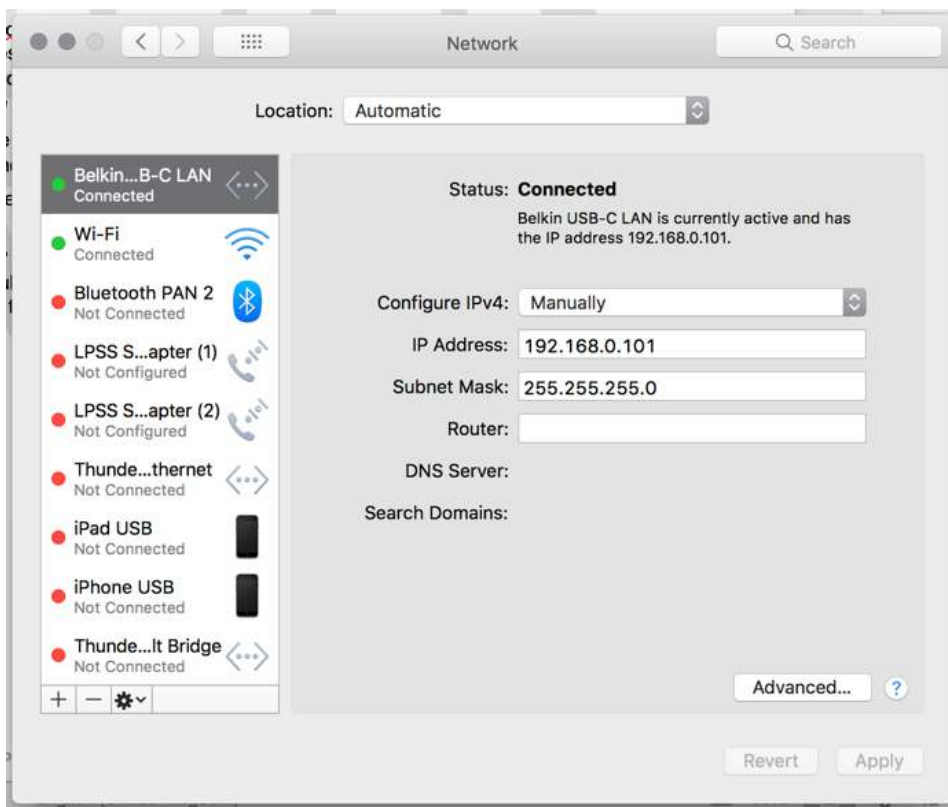

3. In the IP Address box enter 192.168.0. and a value between 1 and 254 except 50, and a subnet mask of 255.255.255.0. Click Apply and your Mac should be ready to connect to a Tessera Processor.

APPENDIX D - DMX CHANNEL ALLOCATIONS

Below, is a example list of the Processor Profiles on a Tessera M2 LED processor with the channel assignments:

Colour				
Main				
Channel Function	DMX	Default DMX	DMX Range (0-255)	Actual Range
Red Gain	1	255	0 - 255	0 - 100
Green Gain	2	255	0 - 255	0 - 100
Blue Gain	3	255	0 - 255	0 - 100
Intensity Gain	4	0	0 - 255	0 - 100
Group 1				
Channel Function	DMX	Default DMX	DMX Range (0-255)	Actual Range
Red Gain	5	255	0 - 255	0 - 100
Green Gain	6	255	0 - 255	0 - 100
Blue Gain	7	255	0 - 255	0 - 100
Intensity Gain	8	0	0 - 255	0 - 100
Group 2				
Channel Function	DMX	Default DMX	DMX Range (0-255)	Actual Range
Red Gain	9	255	0 - 255	0 - 100
Green Gain	10	255	0 - 255	0 - 100
Blue Gain	11	255	0 - 255	0 - 100
Intensity Gain	12	0	0 - 255	0 - 100
Group 3				
Channel Function	DMX	Default DMX	DMX Range (0-255)	Actual Range
Red Gain	13	255	0 - 255	0 - 100
Green Gain	14	255	0 - 255	0 - 100
Blue Gain	15	255	0 - 255	0 - 100
Intensity Gain	16	0	0 - 255	0 - 100
Group 4				
Channel Function	DMX	Default DMX	DMX Range (0-255)	Actual Range
Red Gain	17	255	0 - 255	0 - 100
Green Gain	18	255	0 - 255	0 - 100
Blue Gain	19	255	0 - 255	0 - 100
Intensity Gain	20	0	0 - 255	0 - 100
Group 5				
Channel Function	DMX	Default DMX	DMX Range (0-255)	Actual Range
Red Gain	21	255	0 - 255	0 - 100
Green Gain	22	255	0 - 255	0 - 100
Blue Gain	23	255	0 - 255	0 - 100
Intensity Gain	24	0	0 - 255	0 - 100
Group 6				
Channel Function	DMX	Default DMX	DMX Range (0-255)	Actual Range
Red Gain	25	255	0 - 255	0 - 100
Green Gain	26	255	0 - 255	0 - 100
Blue Gain	27	255	0 - 255	0 - 100
Intensity Gain	28	0	0 - 255	0 - 100

Groups				
Group 1				
Channel Function	DMX	Default DMX	DMX Range (0-255)	Actual Range
X offset	1-2	32767	0 - 65536	-1920 - 1920
Y offset	3-4	32767	0 - 65536	-1080 - 1080
Rotation Offset	5-6	32767	0 - 65536	-180 - 180
Red Gain	7	255	0 - 255	0 - 100
Green Gain	8	255	0 - 255	0 - 100
Blue Gain	9	255	0 - 255	0 - 100
Intensity Gain	10	0	0 - 255	0 - 100

Groups

Group 2				
Channel Function	DMX	Default DMX	DMX Range (0-255)	Actual Range
X offset	11-12	32767	0 - 65536	-1920 - 1920
Y offset	13-14	32767	0 - 65536	-1080 - 1080
Rotation Offset	15-16	32767	0 - 65536	-180 - 180
Red Gain	17	255	0 - 255	0 - 100
Green Gain	18	255	0 - 255	0 - 100
Blue Gain	19	255	0 - 255	0 - 100
Intensity Gain	20	0	0 - 255	0 - 100
Group 3				
Channel Function	DMX	Default DMX	DMX Range (0-255)	Actual Range
X offset	21-22	32767	0 - 65536	-1920 - 1920
Y offset	23-24	32767	0 - 65536	-1080 - 1080
Rotation Offset	25-26	32767	0 - 65536	-180 - 180
Red Gain	27	255	0 - 255	0 - 100
Green Gain	28	255	0 - 255	0 - 100
Blue Gain	29	255	0 - 255	0 - 100
Intensity Gain	30	0	0 - 255	0 - 100
Group 4				
Channel Function	DMX	Default DMX	DMX Range (0-255)	Actual Range
X offset	31-32	32767	0 - 65536	-1920 - 1920
Y offset	33-34	32767	0 - 65536	-1080 - 1080
Rotation Offset	35-36	32767	0 - 65536	-180 - 180
Red Gain	37	255	0 - 255	0 - 100
Green Gain	38	255	0 - 255	0 - 100
Blue Gain	39	255	0 - 255	0 - 100
Intensity Gain	40	0	0 - 255	0 - 100
Group 5				
Channel Function	DMX	Default DMX	DMX Range (0-255)	Actual Range
X offset	41-42	32767	0 - 65536	-1920 - 1920
Y offset	43-44	32767	0 - 65536	-1080 - 1080
Rotation Offset	45-46	32767	0 - 65536	-180 - 180
Red Gain	47	255	0 - 255	0 - 100
Green Gain	48	255	0 - 255	0 - 100
Blue Gain	49	255	0 - 255	0 - 100
Intensity Gain	50	0	0 - 255	0 - 100
Group 6				
Channel Function	DMX	Default DMX	DMX Range (0-255)	Actual Range
X offset	51-52	32767	0 - 65536	-1920 - 1920
Y offset	53-54	32767	0 - 65536	-1080 - 1080
Rotation Offset	55-56	32767	0 - 65536	-180 - 180
Red Gain	57	255	0 - 255	0 - 100
Green Gain	58	255	0 - 255	0 - 100
Blue Gain	59	255	0 - 255	0 - 100
Intensity Gain	60	0	0 - 255	0 - 100

Input Control

SDI A				
Channel Function	DMX	Default DMX	DMX Range (0-255)	Actual Range
Black Level	1	127	0 - 255	-100 - 100
Contrast	2	127	0 - 255	-100 - 100
Hue	3	127	0 - 255	-180 - 180
Saturation	4	127	0 - 255	-100 - 100
Red Shadow	5	127	0 - 255	-100 - 100
Green Shadow	6	127	0 - 255	-100 - 100
Blue Shadow	7	127	0 - 255	-100 - 100
Red Highlight	8	127	0 - 255	-100 - 100
Green Highlight	9	127	0 - 255	-100 - 100

Input Control				
Blue Highlight	10	127	0 - 255	-100 - 100
SDI B				
Channel Function	DMX	Default DMX	DMX Range (0-255)	Actual Range
Black Level	11	127	0 - 255	-100 - 100
Contrast	12	127	0 - 255	-100 - 100
Hue	13	127	0 - 255	-180 - 180
Saturation	14	127	0 - 255	-100 - 100
Red Shadow	15	127	0 - 255	-100 - 100
Green Shadow	16	127	0 - 255	-100 - 100
Blue Shadow	17	127	0 - 255	-100 - 100
Red Highlight	18	127	0 - 255	-100 - 100
Green Highlight	19	127	0 - 255	-100 - 100
Blue Highlight	20	127	0 - 255	-100 - 100
DVI				
Channel Function	DMX	Default DMX	DMX Range (0-255)	Actual Range
Black Level	21	127	0 - 255	-100 - 100
Contrast	22	127	0 - 255	-100 - 100
Hue	23	127	0 - 255	-180 - 180
Saturation	24	127	0 - 255	-100 - 100
Red Shadow	25	127	0 - 255	-100 - 100
Green Shadow	26	127	0 - 255	-100 - 100
Blue Shadow	27	127	0 - 255	-100 - 100
Red Highlight	28	127	0 - 255	-100 - 100
Green Highlight	29	127	0 - 255	-100 - 100
Blue Highlight	30	127	0 - 255	-100 - 100

Input Controls +				
Main Colour				
Channel Function	DMX	Default DMX	DMX Range (0-255)	Actual Range
Red Gain	1	255	0 - 255	0 - 100
Green Gain	2	255	0 - 255	0 - 100
Blue Gain	3	255	0 - 255	0 - 100
Intensity Gain	4	0	0 - 255	0 - 100
SDI A				
Channel Function	DMX	Default DMX	DMX Range (0-255)	Actual Range
Hue	5	127	0 - 255	-180 - 180
Saturation	6	127	0 - 255	-100 - 100
Red Shadow	7	127	0 - 255	-100 - 100
Green Shadow	8	127	0 - 255	-100 - 100
Blue Shadow	9	127	0 - 255	-100 - 100
Red Highlight	10	127	0 - 255	-100 - 100
Green Highlight	11	127	0 - 255	-100 - 100
Blue Highlight	12	127	0 - 255	-100 - 100
SDI B				
Channel Function	DMX	Default DMX	DMX Range (0-255)	Actual Range
Hue	13	127	0 - 255	-180 - 180
Saturation	14	127	0 - 255	-100 - 100
Red Shadow	15	127	0 - 255	-100 - 100
Green Shadow	16	127	0 - 255	-100 - 100
Blue Shadow	17	127	0 - 255	-100 - 100
Red Highlight	18	127	0 - 255	-100 - 100
Green Highlight	19	127	0 - 255	-100 - 100
Blue Highlight	20	127	0 - 255	-100 - 100
DVI				
Channel Function	DMX	Default DMX	DMX Range (0-255)	Actual Range
Hue	27	127	0 - 255	-180 - 180
Saturation	28	127	0 - 255	-100 - 100
Red Shadow	29	127	0 - 255	-100 - 100

Input Controls +				
Green Shadow	30	127	0 - 255	-100 - 100
Blue Shadow	31	127	0 - 255	-100 - 100
Red Highlight	32	127	0 - 255	-100 - 100
Green Highlight	33	127	0 - 255	-100 - 100
Blue Highlight	34	127	0 - 255	-100 - 100
Test Pattern	35	0	0 - 9	Normal Video
			10 - 14	Brompton Glyph Pattern
			15 - 19	Brompton Glyph Overlay
			20 - 24	White Test Pattern
			25 - 29	Red Test Pattern
			30 - 34	Green Test Pattern
			35 - 39	Blue Test Pattern
			40 - 44	Cyan Test Pattern
			45 - 49	Magenta Test Pattern
			50 - 54	Yellow Test Pattern
			55 - 59	Black Test Pattern
			60 - 64	Grid Test Pattern
			65 - 69	Scrolling Grid Test Pattern
			70 - 74	Checkerboard Test Pattern
			75 - 79	Scrolling Checkerboard Test Pattern
			80 - 84	Gradient Test Pattern
			85 - 89	Scrolling Gradient Test Pattern
			90 - 94	Colour Bars Test Pattern
			95 - 99	Gamma Test Pattern
			100 - 104	Strobe Test Pattern
			105 - 109	SMPTE Bars Test Pattern
			110 - 114	Scrolling SMPTE Test Pattern
			115 - 119	Custom Test Pattern
			120 - 124	45° Grid Test Pattern
			125 - 129	Scrolling 45° Grid Test Pattern
			130 - 255	Not Utilised
Blackout	36	0	0 - 9	Safe
			10 - 255	Blackout
Freeze	37	0	0 - 9	Safe
			10 - 255	Freeze
Preset	38	0	1 - 127	No Effect
			128 - 255	Presets 1 - 127

APPENDIX E - WARRANTY

Brompton Technology Limited ("Brompton") warrants that its Products will be free from defects in materials and workmanship for a period of two (2) years ("Warranty Period") from the original date of purchase and that any spare parts will be free from defects in materials and workmanship until the end of the Warranty Period or 3 months from the date of which they have been incorporated into the Product, whichever is the later.

In the event that warranty service is required, please contact Brompton's support email address: support@bromptontech.com

WARRANTY CONDITIONS

1. Brompton's obligations are limited to the repair of the defective part or, at its discretion, replacement of the product or the defective part with a new product or part.
2. The warranty is only valid where Brompton has received payment in full for the product and the serial number has not been defaced.
3. It is the customer's obligation to notify Brompton within one week of any suspected defect and to return the product prepaid to Brompton's nominated service address. Product will only be received under warranty when they are returned with a recognised RMA number that has been issued by Brompton.
4. Warranty repairs must be carried out by a nominated Brompton employee or Brompton approved agent or service technician. No reimbursement will be made for repairs carried out by non-Brompton personnel or dealers, and any such repair work or damage to the product caused by such repair work will not be covered by this warranty.
5. Product is not considered to be defective in materials or workmanship by reason that it requires adaptation to conform to national or local technical or safety standards in force in any country other than the one for which the product was originally designed or manufactured. This warranty will not cover, and no reimbursement will be made for, such adaptation or any damage which may result. 6. This warranty covers none of the following:
 1. Maintenance and repair or replacement of parts due to normal wear and tear.
 2. Cost relating to transport, removal or installation of the Product.
 3. Misuse, including the failure to use the product for its normal purposes or incorrect installation.
 4. Damage caused by lightning, water, fire, acts of God, war, public disturbances, incorrect mains voltage, improper ventilation or any other cause beyond the control of Brompton.
 5. This warranty is valid for any person who legally acquired possession of the product during the warranty period.
6. The customer's statutory rights in any applicable national legislation arising from the purchase are not affected by this warranty. The rights under this warranty are the customer's sole rights and Brompton shall not be liable for any indirect or consequential loss, damages for any loss of use, time, profits or income, or any damage to related equipment, materials or consumable parts.

GLOSSARY

Here are a list of useful terms used throughout Brompton Technology's products and user interface.

1

1:1 pixel mapping

Mapping a tile so that one pixel of content controls one pixel on the tile with no interpolation to compensate for the pitch of that tile

12G-SDI

Supports bitrates of up to 12 Gbit/s and formats of up to 2160p60

14 Way Colour Corrector

A feature giving the ability to adjust primary, secondary, tertiary, white and black colours, available on M2 and SX40

3

3G-SDI

Single serial link that allows that supports Bitrates up to 2.970 Gbit/s, and 2.970/1.001 Gbit/s and formats up to 1080p60

A

Active Area

Area of canvas that is covered by captured content from viewport, shown by a dashed line border

Add Fixtures From Library

Gives you the ability to add fixtures onto the canvas without having any panels connected to the Processor

Add Fixtures From Network

Add fixtures which are connected to the Processor onto the canvas

Additional Video Delay

Adds additional frames of latency to the Processor

Anchor Point

The point around which a group of panels rotates, indicated by a small circle.

Array

A set of panels built in the canvas view (as distinct from 'group').

Art-Net

Distribution protocol allowing DMX512 and RDM data to be transported over ethernet

Aspect Ratio

Aspect ratio refers to the dimensions of the screen or source image. There are standards such as 4:3 or 16:9.

Association

Placing panels either online or added from network to your canvas

B

Beaconing

A mode in which a fixture on the network displays its Identify test pattern and the status LED on the rear flashes.

Blackout

Blackout for Tessera systems gives the user control to turn connected fixtures off at any point by either pressing the front panel button or selecting Blackout from the pipeline tiles.

Blind mode

Method of associating fixtures to the canvas without indication from the physical fixtures. Useful for quietly associating without disturbing others.

Brompton Technology

Brompton Technology is a registered trademark owned by Carallon Ltd

C

Cable Redundancy

When fixtures are cabled together in a loop from one port to another on a Tessera processor. Requires enabling when creating a project or from the Network property editor.

Calibration profile

Calibration profiles are normally stored on a fixture's LED modules and are created to drive the fixture at its best or for customer needs.

Canvas

The grey rectangle with a solid border in the Main Project Screen.

Canvas Background

Places an imported image onto the canvas which can be used as a guide when mapping panels

Colour Replace

A feature to replace and manipulate one specific colour, available on M2 and SX40

Custom Test Pattern

A slot for a user to import a JPEG / PNG file as a test pattern.

D

Daisy-chain

Often used with Tessera compatible fixtures, when a fixture is continually connected from one fixture to another.

Dark Magic

Dark Magic improves the visual quality of the output when operating at low brightnesses.

Delay/Latency

The time difference added to a video signal by processing. Delay for when it's added intentionally (e.g. on the System tab) and Latency for when it's unintentional (e.g. Low Latency Mode)

DisplayPort

Designed to replace standards like DVI and VGA. Displayport is required to connect a local monitor to control Tessera processors.

DMX512

Standard for external digital control of fixtures using a control desk.

DP++

Dual-Mode DisplayPort is a standard which allows DisplayPort sources to use simple passive adapters to connect HDMI or DVI displays.

DVI-D

DVI-D provides a digital only signal

DVI-I

DVI-I can support digital and analog signals

F

Failover

When a system encounters failure or abnormal termination, failover is switching to a redundant or standby processor.

Fibre optic

A fiber optic cable is a network cable that contains strands of glass fibers inside an insulated casing. They're designed for long distance, high-performance data networking and telecommunications.

Firmware

Software required for Tessera products to function. Check www.bromptontech.com for the latest updates.

Fixture Library

The fixture library is a database containing fixture firmware required for the processor to communicate with fixtures.

Fixture Packs

A fixture pack is a collaboration of fixture firmware compiled by Brompton Technology. Made available through www.bromptontech.com New fixture packs are often made available along with processor firmware releases.

Fixtures

Brompton refers to fixtures as the LED devices which connects to our processors or XD units. Fixtures are usually rectangular or square in shape but can also come in all shapes and sizes.

G

Gamma

Gamma correction is a way to adjust the brightness of mid-tones in the image without affecting the very dark or very bright areas of the image.

Genlock Source

Determines which input is selected as reference signal for the Processor.

Gigabit Ethernet

Gigabit Ethernet (GbE or 1 GigE) is the various technologies for transmitting Ethernet frames at a rate of a gigabit per second (1,000,000,000 bits per second), as defined by the IEEE 802.3-2008 standard.

H

HDMI

Proprietary audio/video interface for transmitting uncompressed video data and compressed or uncompressed digital audio data from an HDMI-compliant source device.

HDMI 2.0

HDMI 2.0 increases the maximum bandwidth to 18.0 Gbit/s 8b/10b encoding for video transmission like previous versions, giving it a maximum video bandwidth of 14.4 Gbit/s. This enables HDMI 2.0 to carry 4K video at 60 Hz with 24 bit/px color depth. HDMI 2.0 include support for the Rec. 2020 color space

Heat Map

Projects a heat map across the user interface for all associated panels

Histogram

A representation of the colour output of the tiles in a given moment

Hue

Hue is the main indication of colour

L

Live Control

The use of DMX, Artnet, sACN or Tessera Control to change values within the Processor

Low Latency Mode

Reduces overall latency by one frame, Tessera T1 and M2 processors work at a latency of 3 frames. In low latency mode, the latency is reduced to 2 frames. Tessera S4 is always in low latency mode. Using non-standard canvas sizes automatically switch M2 and T1 processors into low latency mode.

M

Main Project Screen

This screen refers to the overall view containing configuration options for the canvas, fixtures, topology and many other options.

Module

As fixture refers to a whole LED device, a module is often a removable smaller LED panel with a connector plugged into the fixture.

N

Network bit depth

Network bit depth refers to the bit depth at which video data is encapsulated, packetized and sent to connected fixtures.

New Project Wizard

The popup window for creating a new project that is launched when the 'New...' option is selected

O

OSCA

A feature for correcting seams between panels / modules and correcting colour / batch issues per module.

OSD

On-Screen Display, created by Brompton Technology for R2 based fixtures. Displays status information of a fixture on the fixture.

P

Pipeline

A section shown above the main project screen, its intention is for the user to configure settings in order of left to right. Each pipeline section is displayed as a pipeline tile.

Pixel pitch

Pixel pitch refers to the density of pixels. A smaller pixel pitch indicates higher pixel density and higher resolution. Pixel pitch is important because it influences viewing distance.

Presets

Used to trigger pre-defined settings within the Processor, can be triggered manually or via Live Controls

Processor Redundancy

When 2 or more processors are cabled together through XD units and outputting identical content to the same fixtures. If one processor crashes or fails, the backup processor will take over outputting. Currently only available with Tessera SX40.

Property Editor

A section that appears in Tessera UI when either a pipeline tile or fixtures are selected. Property editors display relevant information and configurable settings.

Protocol Bit Depth

The number of bits per colour sent in video data over the Tessera protocol

R

Rear Edit

Changes the perspective of the canvas to reflect the layout when standing behind the LED Screen

Root Nodes

Root nodes are a control and power box required for connecting and controlling sub-fixtures. Root nodes house a R2 receiver card.

S

Saturation

Saturation affects depth of colour in an image or video. Reducing saturation will give a mono-chrome image while increasing saturation enhances the colours to give a more vibrant image.

Seams

When fixtures are built into a wall, mechanical tolerances can cause small gaps between fixtures. There is often a thin gap between each fixture. Within Tessera manual, this gap is referred to as a seam. Refer to OSCA for more details.

String

An unbroken sequence of fixtures from a port on a switch or direct from the processor output.

Sub-fixtures

Sub-fixtures do not have a Tessera interface and so cannot be connected directly to a Processor or XD output. They instead need to be connected through a single power/control box

T

Tessera

The Tessera system comprises processors, distribution units, receiver cards and software. These elements can be used with a wide range of LED fixtures.

Tessera Control

Tessera Control is a remote application to control multiple processors and adjust video output settings.

Tessera M2

The most popular processor to drive HD content. It can control a nominal 2 million pixels over four 1 Gigabit outputs to a fixture count of up to 2000. Supports 3G-SDI and DVI-I inputs.

Tessera Offline Editor

Tessera Offline Editor is a tool used for planning and mapping fixtures before connecting to a processor or before fixtures are connected.

Tessera Remote

Software developed by Brompton Technology to remotely connect to a processor using a Windows or Apple computer.

Tessera S4

Ideal for high resolution screens. The S4 processor does not have the front-side processing, scaling or degree by degree rotation of the T1 and the M2 but can control the same number of pixels across four Gigabit outputs as the M2

Tessera SX40

Currently our highest capacity processor, able to support a nominal 9 million pixels and 4k canvas resolutions with HDMI 2.0 and 12G SDI inputs. Four 10 Gigabit ports allow data transfer using fibre or CAT6 copper cable. The SX40 can support up to 2000 connected fixtures and offers maximum flexibility with the use of the XD distribution system

Tessera T1

Ideal for creative shows requiring flexibility over number of fixtures. It has a DVI-D input and supports a capacity of 0.5 million pixels in a HD canvas. The T1 includes most of the main features available with the Tessera systems, with one output port supporting up to 500 fixtures.

Topology

With Tessera systems, the topology refers to how fixtures are cabled to the processor, the route of where each panel is connected and to which port of the processor.

Transceiver

A transceiver is a device comprising both a transmitter and a receiver that are combined and share common circuitry or a single housing

V

Viewport

Region of incoming video feed captured to canvas.