



Ethernet - DMX8 MkII Range

User Guide - V4 rev3



Ethernet - DMX8 MkII Range User Guide - V4 rev3
Document lu_01_00037_3_man

Copyright © 2003-2015 .
All rights reserved.

No part of this documentation may be reproduced or transmitted in any form or by any means, electronic or mechanical, including photocopying and recording, without the prior written permission of Luminex.

The information in this documentation is supplied without warranty of any kind, either directly or indirectly, and is subject to change without prior written notice. Luminex, its employees or appointed representatives will not be held responsible for any damages to software, hardware, or data, howsoever arising as a direct or indirect result of the product(s) mentioned herein.

Issued by:

Publications Department,
Luminex LCE,
Berkenlaan 8A,
Hechtel - Eksel,
B-3940,
Belgium.

Documentation reviewed April 22, 2015, by Bart Swinnen.
Printed in the EU.

Table of Contents

Warranty information.....	5
Limited warranty.....	5
Returning under warranty.....	5
Freight.....	5
General.....	6
Packaging.....	6
Description.....	6
Specification.....	6
Dimensions.....	6
Weight.....	7
Electrical.....	7
Connectors.....	7
Environmental.....	7
Connectivity.....	8
Rear Panel – Side Panel.....	8
Mains.....	8
DMX input / output.....	9
Interface.....	10
Front panel.....	10
Ethernet port.....	10
DMX input / output.....	10
Status indication.....	11
Status indication.....	11
Front end display information.....	11
Reset the node (Out of jail).....	13
Web interface.....	14
Status.....	14
Setup.....	15
Node.....	15
DMX Routing.....	16
Merging Policies :.....	18
Inputs (Local mode).....	19
Inputs (IP Merging).....	21
Outputs (IP Merging).....	21
Recover channel.....	24
Network settings.....	26
IP Settings.....	26
Global.....	27
DMX details.....	27
Miscellaneous.....	28
Toolbox.....	29
Profile manager.....	29
Snapshot manager.....	30
Firmware upgrade.....	32
Toubleshooting.....	34
Additional Documentation.....	35
Credits:.....	35

Warranty information

Limited warranty

Unless otherwise stated, your product is covered by a two (2) years parts and labor limited warranty. It is the owner's responsibility to furnish receipts or invoices for verification of purchase, date, and dealer or distributor. If purchase date cannot be provided, date of manufacture will be used to determine warranty period.

Returning under warranty

Any Product unit or parts returned to Luminex LCE must be packaged in a suitable manner to ensure the protection of such Product unit or parts, and such package shall be clearly and prominently marked to indicate that the package contains returned Product units or parts. Accompany all returned Product units or parts with a written explanation of the alleged problem or malfunction.

Freight

All shipping will be paid by the purchaser. Items under warranty shall have return shipping paid by the manufacturer only in the European Union. Under no circumstances will freight collect shipments be accepted. Prepaid shipping does not include rush expediting such as air freight. Air freight can be sent customer collect in the European Union.

Warranty is void if the product is misused, damaged, modified in any way, or for unauthorized repairs or parts.

Packaging

- Ethernet-DMX8 MkII

- 1 x Ethernet – DMX8 MkII
- 1 x User guide

- Ethernet-DMX8/Truss MkII

- 1 x Ethernet – DMX8 MkII Truss
- 1 x Powercon male connector
- 1 x User Guide

Description

The Ethernet-DMX8 MkII is an Ethernet node that serves 8 x DMX512 outlets, compatible with the following protocols: DMX512, DMX512-A, RDM (ANSI E1.20), sACN (ANSI E1.31) and Art-Net™.

All 8 outlets can be used as input or output. The Ethernet links are 100BaseTx connections on shielded Neutrik RJ45 Ethercon connectors.

All configuration can be done over Ethernet through a built in website, or the front panel display.

This all comes in a 19" unit high metal housing for the Ethernet-DMX8 MkII. The Ethernet-DMX8/Truss MkII comes in a rugged truss mountable metal housing with two M10 inserts. This enclosure allows to use the node in a truss, on a wall or as a table top device.

Specification

• Dimensions

Ethernet-DMX8 MkII

482 x 183 x 44 (mm)
19" x 7,2" x 1,73"
Package: 520 x 235 x 50 (mm)

Ethernet-DMX8 MkII Truss

240 x 180 x 90 (mm)
9,44" x 7,08" x 3,54"
Package: 310 x 260 x 110 (mm)

- **Weight**

Ethernet-DMX8 MkII: 2,3 kg
Ethernet-DMX8/Truss MkII: 3,1 kg

- **Electrical**

Ethernet-DMX8 MkII:

Voltages: 90 – 260 VAC
Frequency: 47 – 63 Hz
Rated power: 20 W
Fuse: 125V – 250V, 1A, Slow blow only (5mm x 20mm)

Ethernet-DMX8/Truss MkII:

Voltages: 100 – 240 VAC
Frequency: 50 – 60 Hz
Rated power: 20 W
Fuse: 250V 1A, Slow blow

- **Connectors**

2 x shielded Neutrik RJ45 Ethercon connector
(front and rear for Ethernet-DMX8 MkII, front and side for Ethernet-DMX8 MkII Truss)
8 x shielded Neutrik gold plated 5 pin XLR (female)
8 x optic and galvanic isolated DMX port
1 x IEC inlet with fuse holder (Rack version only)
1 x Neutrik Powercon inlet (Truss version only)

- **Environmental**

Operating temperature: 0 ~ 60°C (32 ~ 140°F)
Storage temperature : -10 ~ 70°C (14 ~ 158°F)
Humidity: 5-95% non condensing

Connectivity

Rear Panel – Side Panel

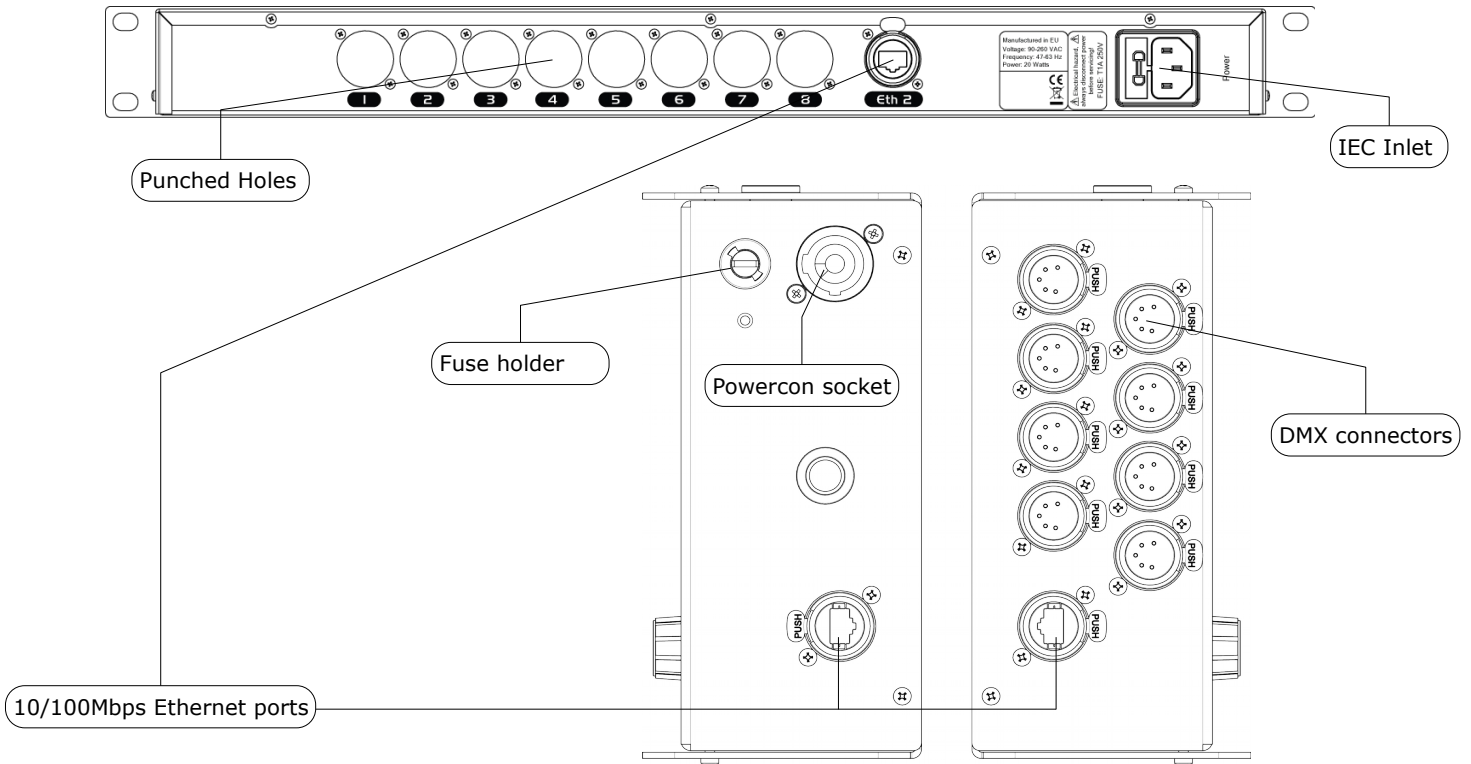

- **Mains**

Ethernet-DMX8 MkII

The device operates with an AC voltage between 90V and 260V within a frequency range of 47Hz and 63Hz.

An IEC socket is located at the rear of the unit. Please use an IEC plug compliant cable to feed power to the unit.

Luminex recommend the use of a power cable, fitted with an IEC-Lock™ plug. The IEC-Lock™ system offers a reliable way to connect the power cable to the unit.

!!! This equipment must be earthed !!!

- **Punched holes**

The unit offers 8 punched holes to easily install 8 optional DMX input connectors, or to reverse the board.

- **Ethernet**

1 Neutrik RJ45 Ethercon is provided as Ethernet link.

Ethernet-DMX8 MkII Truss

The device operates with an AC voltage between 100V and 240V within a frequency range of 50Hz and 60Hz.

A Neutrik PowerCon IN connector can be connected to the device. Please use an authorized plug and connect the cores in the mains lead in accordance with the following scheme:

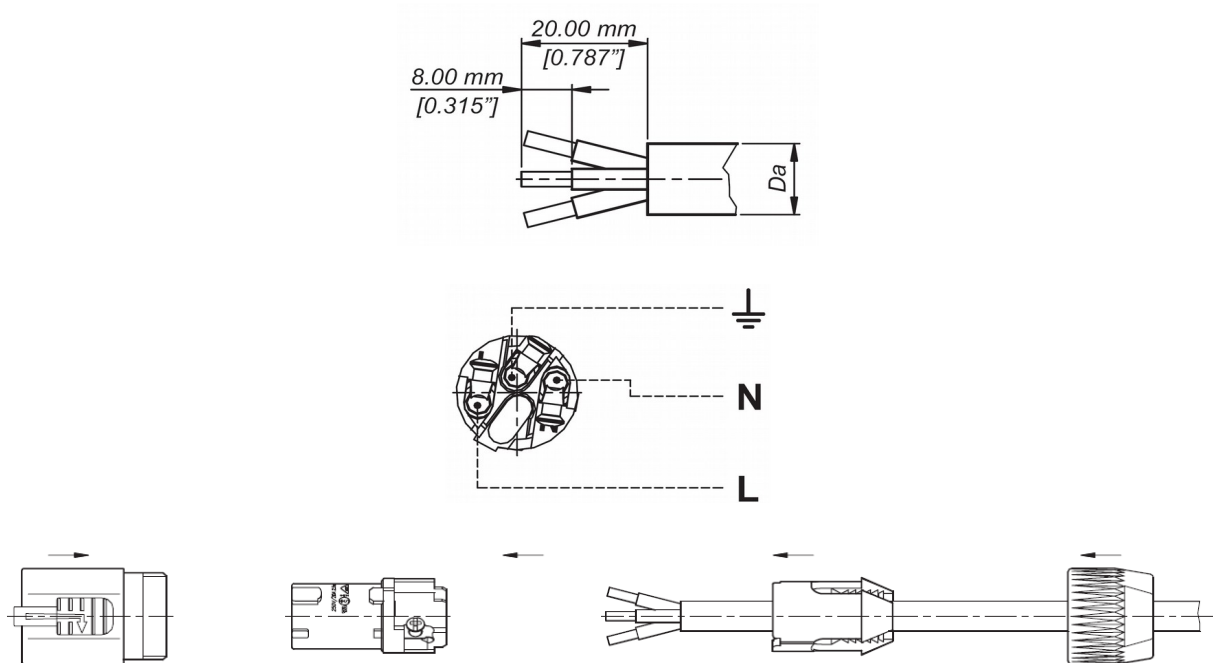

Green / Yellow: Earth
Blue: Neutral
Brown: Live

!!! This equipment must be earthed !!!

- **Ethernet**

1 Neutrik RJ45 Ethercon is provided as Ethernet link.

- **DMX input / output**

8 shielded Neutrik 5 pin gold plated female connectors are provided as outlet (input or output). All DMX outlets are optic and galvanic isolated. See detailed pinout on page 11.

Interface

Front panel

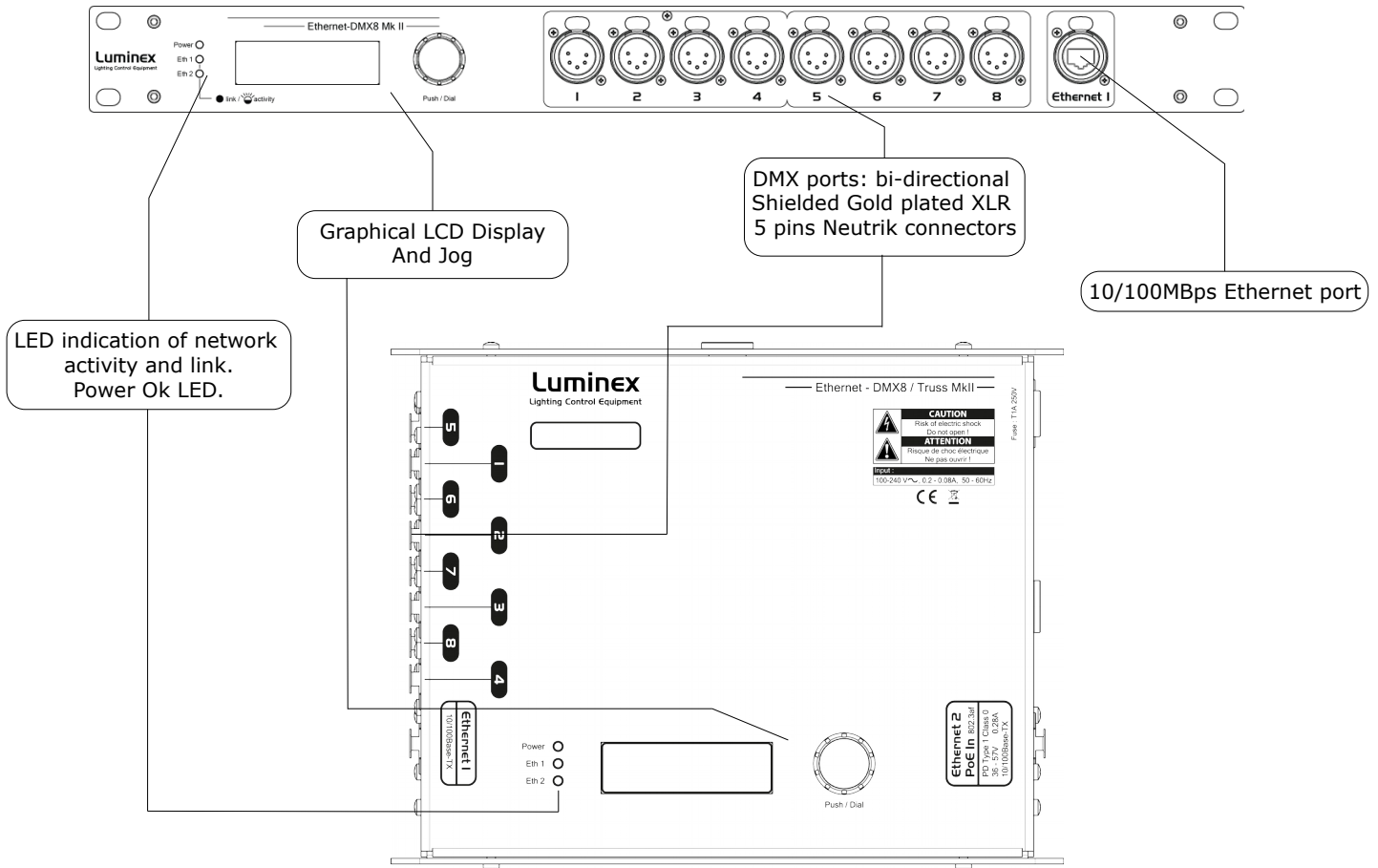

Ethernet-DMX8 MkII

The front panel interface is provided with 1 graphical LCD display, 1 jog, 1 Ethernet port, 8 DMX outlets and 3 indication LEDs. Standard DMX port routing and advanced features like merging, backup, etc can be configured from the front end LCD display, from the built in Web interface or through LumiNet Monitor V2 Software.

- **Ethernet port**

1 Neutrik RJ45 Ethercon is provided as Ethernet link.

- **DMX input / output**

8 shielded Neutrik 5 pin gold plated female connectors are provided as outlet (input or output). All DMX outlets are optic and galvanic isolated.

Connector	Function
Pin 1	Signal common (0 volt)
Pin 2	Data complement (-)
Pin 3	Data true (+)
Pin 4	Not used
Pin 5	Not used

All outlets are compliant with the DMX512-A timing specification and are terminated and rebiased.

Status indication

3 LEDs are provided to indicate Network link and activity (Ethernet ports 1&2), and power Ok.

Ethernet-DMX8/Truss MkII

Status indication

3 LEDs are provided to indicate Network link and activity (Ethernet ports 1&2), and power Ok.

The front panel interface is provided with 1 graphical LCD display and 1 jog. Standard DMX port routing and advanced features like merging, backup, etc can be configured from the front end LCD display, from the built in Web interface or through LumiNet Monitor V2 Software.

- **Front end display information**

Four indication screens will rotate continuously on the display with an interval of a few seconds.

Screen 1 – Model and firmware version

```
Ethernet-DMX8 MkII
ID:001
Firmware Ver:4.0.9
```

This screen informs you on the type of model of Ethernet-DMX8 MkII you're using. It gives also the ID number, and the firmware version the node is actually running.

Screen 2 – Network settings

```
1:Node FOH
IP: 2.193.145.1
Netmask: 255.0.0.0
```

```
2:Node FOH
IP: 2.193.145.2
Netmask: 255.0.0.0
```

These two screens display all the information of the two virtual nodes the Ethernet-DMX8 embeds. Each node have a short name entered through the Web interface. The screens give also the complete network setting information, such as IP address and netmask of each node.

Screen 3 – Model and firmware version

```
Port: 1 2 3 4 5 6 7 8
Dir: 0 0 0 0 0 0 I I
Mode: N H N N N N N N
```

This screen gives a complete overview of the DMX ports settings: the second raw gives information on the direction set on each port. The third raw informs you on the mode set on each outlet.

Regarding the direction, different letters will appear to show the mode set on the outlet : N (Normal), H (HTP merge), L (LTP merge), C (Custom), B (Backup), M(Merge), Z (Zero). A "-" means either the outlet is disable, either the outlet is set as an output, but no Art-Net™ data have been detected with the related universe.

See page 16 for the explanation of each available mode.

- **Unlock the node**

When the node is password protected through the Web interface, it will automatically lock the access to the Web interface. To unlock the node, enter the password in the password field (login = admin).

- **Reset the node (Out of jail)**

This useful function makes it possible to bring the node in a factory default.

1. Press and hold the jog on the front panel
2. Power up the device
3. wait until the converter to display the reset confirmation
4. confirm
5. The unit is now rebooting to its default settings

Web interface

Status

The complete device can be configured from an intuitive Web interface. You just have to browse to the IP address of the unit. If you do not know the IP address, you can quickly discover it through the front end display or by running Luminet Monitor V2 software (free downloadable tool), which shows all Luminex nodes on the network.

Make sure that the computer, you use to browse, is setup in the correct network address range (IP 2.x.x.x or 10.x.x.x and subnet 255.0.0.0).

When you're not using a complete network setup (Ethernet switches, hubs, routers, WLAN, ...), you can also use either a cross Ethernet cable or straight Ethernet cable to directly connect the unit to your computer.

After all connections and setup on the computer are completed, open your favorite web browser (we recommend Firefox) and enter the IP address you want to reach in the URL field : [Http://2.x.x.x](http://2.x.x.x)

The screenshot shows the 'Status' page of the web interface. On the left is a 'Navigation Bar' with links for 'Status', 'Set up' (node 1, node 2, global), 'Toolbox' (profile manager, snapshot manager, firmware upgrade), and 'Help'. The main content area is titled 'Status' and shows 'Active Profile: None'. It is divided into three sections: 'DMX Routing', 'Global Settings', and 'Network Settings'. The 'DMX Routing' section contains a table with 8 outlets. The 'Global Settings' section shows ID No: 001, Trigger universes: Disabled, and DMX details. The 'Network Settings' section compares Node 1 and Node 2 settings.

Direction	Protocol	Universe	Mode	IP Merge	Legend	Unicast	RDM	Info
Outlet 1:	output	ArtNet	000 (0x00)	disabled	disabled	Outlet 1	NA	
Outlet 2:	output	ArtNet	001 (0x01)	disabled	disabled	Outlet 2	NA	
Outlet 3:	output	ArtNet	002 (0x02)	disabled	disabled	Outlet 3	NA	
Outlet 4:	output	ArtNet	003 (0x03)	disabled	disabled	Outlet 4	NA	
Outlet 5:	output	ArtNet	004 (0x04)	disabled	disabled	Outlet 5	NA	
Outlet 6:	output	ArtNet	005 (0x05)	disabled	disabled	Outlet 6	NA	
Outlet 7:	output	ArtNet	006 (0x06)	disabled	disabled	Outlet 7	NA	
Outlet 8:	output	ArtNet	007 (0x07)	disabled	disabled	Outlet 8	NA	

	Node 1	Node 2
IP:	2.0.0.8	2.0.0.9
Netmask:	255.0.0.0	255.0.0.0
Port:	0x1936	0x1936
MAC:	00:50:C2:9C:93:01	00:50:C2:9C:93:01
Short name:	Ethernet-DMX8MkII	Ethernet-DMX8MkII
Long name:	Ethernet-DMX8 MkII - Node A - Rack Version	Ethernet-DMX8 MkII - Node B -Rack Version

You'll end up at the status page of the device. This page has a complete overview of the device settings. The overview shows the actual DMX and network setting / routing of the complete device.

The Web interface offers several languages. Select the language that fits your needs in the drop down menu located on the top right side of the Web page.

Setup

Choose one of the items in the sub menu to setup the device.

Once in a setup page, help is available on almost every field title. Just click on the question mark next to the topic. A pop up frame will display the overall information of each term displayed on the Web interface.

- **Node**

To setup the node click on the appropriate sub menu item in the Setup navigation bar (Node).

Set Up:: Node 1 (Outlet 1 - 4)

DMX Routing

Message:

	Direction [?] input/output	Protocol [?] ArtNet/sACN	Universe [?] -1/+1 -4/+4 -16/+16	Mode [?] disabled/normal	IP Merging [?]	Legend [?]	Unicast [?]	RDM [?]
1	Output	ArtNet	0 (0)	Normal	HTP	From MS		AD: v
2	Output	ArtNet		Normal	Custom	Stage Left		
3	Input	sACN	2:100	Merge	Disabled	Desk 1	239.255.0.2	
4			Ch 0	HTP		Desk 2		

Submit Changes Reset

Network Settings

IP Settings

ArtNet compliant? [?]

Auto ArtNet: [?]

IP: 2.0.0.8 [?]

Netmask: 255.0.0.0 [?]

Broadcast: 255.255.255 [?]

Port (Hex): 1936 [?]

Node Identification

Short name: Ethernet-DMX8Mkl [?]

Long name: Ethernet-DMX8 MkII - Node A - Rack Version [?]

Submit Changes Reset

This is the main settings page. You can setup every single outlet of the node, as input or output. Select the outlet's direction, mode, protocol and universe, enable/disable RDM traffic. Here you can also change the IP address, Netmask, port and the Art-Net™ short and long name indication. Node 1 link will lead you to outlets 1 to 4 configuration. Node 2 link will lead you to outlets 5 to 8 configuration page.

- **DMX Routing**

To better understand the use of all features, let's define each category of this menu:

Direction : Set the direction you need to the outlet, either Input or Output. Depending your selection, some features won't be available in the other categories.

Protocol : Determines the network protocol used for the outlet (Art-Net™ or streaming over ACN (sACN E1.31))

Universe :

ArtNet: Select one of 256 possible universes available in the Art-Net™ protocol. This is used for addressing DMX lines on Art-Net™. The hexadecimal value of the universe is in between brackets. The first digit equals to the Art-Net™ subnet and the second to the Art-Net™ universe within that subnet.

sACN : Select the sACN universe to use for addressing DMX lines on sACN. You can enter a numeric value between 1 and 63999. In case of an input, the priority of the universe can be set by adding a colon and the priority value. The priority level can go from 0 to 200. A higher level has a higher priority. (ex: 678:100 means universe 678 at priority level 100)

Mode : According to the direction you set on the outlet, this menu offers several mode :

Input : Disabled : Outlet is disabled, better for node performance.
 Normal : Outlet set as normal input
 Merge : Allow to merge 2 DMX streams.

When outlet 1 is configured as a merged input, the next outlet (2) will be automatically set as input as well.

Output : Disabled : Outlet is disabled, better for node performance.
 Zero : Send all channels with a zero value (for maintenance only)
 Normal: Normal output.

IP Merging : This special feature allows you to merge up to 4 different Art-Net™ or sACN streams through the network. The merging policy will be mainly applied on the Output, except for IP backup.

Legend : Set a legend to the outlet, useful to remind yourself what's connected to that outlet.

Unicast : Art-Net™ is a broadcast protocol, which means that each packet sent from a single source will be received by all actives equipment on the network. Unicast allows you to cast you data to a selected IP address, resulting in a better use of network bandwidth.

RDM : Enable / disable RDM. Enabling RDM allows RDM traffic to be transported from/to outlet over the network and back. The nodes will act as an unmanaged proxy device. When set as output it is also possible to enable Adaptive Discovery (AD). AD will continuously check for new and disappeared RDM devices on the output.

Once RDM is activated, you'll notice a cross in the status page. Click on this cross to see the list of discovered RDM devices (Illustration 1) attached to the node.

Status

Active Profile: None

DMX Routing

Direction	Protocol	Universe	Mode	IP Merge	Legend	Unicast	RDM	Info
Outlet 1: output	ArtNet	000 (0x00)	normal	HTP	From MS	NA	X	
Outlet 2: output	sACN ArtNet	001 (0x01) 001 (0x01)	normal	custom	Stage Left	NA		2.0.0.1 2.0.0.2
Outlet 3: input	sACN	00002:100	merge	disabled	Desk 1	239.255.0.2		
Outlet 4: input		ch. 000	HTP	disabled	Desk 2	NA		
Outlet 5: output	ArtNet	004 (0x04)	disabled	disabled	Outlet 5	NA		
Outlet 6: output	ArtNet	005 (0x05)	disabled	disabled	Outlet 6	NA		
Outlet 7: output	ArtNet	006 (0x06)	disabled	disabled	Outlet 7	NA		
Outlet 8: output	ArtNet	007 (0x07)	disabled	disabled	Outlet 8	NA		

Global Settings

ID No: 001
 Trigger universe: Disabled
 DMX details:
 ↳ framerate: 36 Fps
 ↳ break: 184 µS
 ↳ Continuously

Network Settings

	Node 1	Node 2
IP:	2.0.0.8	2.0.0.9
Netmask:	255.0.0.0	255.0.0.0
Port:	0x1936	0x1936
MAC:	00:50:C2:9C:93:01	00:50:C2:9C:93:01
Short name:	Ethernet-DMX8MkII	Ethernet-DMX8MkII
Long name:	Ethernet-DMX8 MkII - Node A - Rack Version	Ethernet-DMX8 MkII - Node B - Rack Version

UId

44:45 - 04:D5:AF:B7

45:4E - 02:05:65:05

© 2010 Luminex LCE

Illustration 1: Discovered RDM devices

All setting that are not applicable for the actual setting will be grayed out or marked as N/A (Not Applicable).

- **Merging Policies :**

The Ethernet-DMX8 MkII firmware offers enhanced merging policies that fits to all kind of setup, even the most complex one!

4 available merging policies can be applied on your DMX network, in 2 main setup categories :

Local merging : 2 different DMX streams are merged on the same physical device (Node). The merging policy will be mainly set on Inputs.

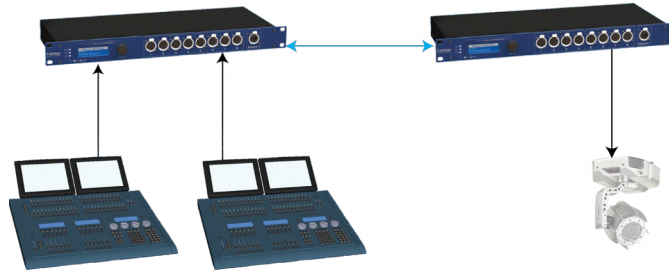

Illustration 2: Local Merging

IP Merging : This special feature allows you to merge up to 4 different Art-Net™ or sACN streams through the network. The merging policy will be mainly applied on the Output, except for IP backup.

Available policies :

- HTP : Highest Take Precedence; Commonly used to merge dimmer channels. Up to 4 Art-Net™ or sACN sources can be merged.
- LTP : Latest Take Precedence; Better suited when using moving lights. Up to 4 Art-Net™ or sACN sources can be merged.
- Backup : Can be used either on input or output. When used on input, this policy allows you to add a backup DMX console on the second input. When used on a custom output, the policy allows you to add a backup Art-Net™ or sACN source on the network.
- Custom : This is the most complete and efficient policy. This mode offers you to choose what policy to apply for each channel of each universe, and also to create a complete custom soft patch. By more, the merging policy can be remotely triggered by DMX. Up to 2 DMX or Art-Net™ or sACN sources can merged thanks to that policy.

The available policies differs if you use either inputs or outputs :

Inputs (Local mode)

	Direction	Protocol	Universe	Mode
Outlet 1	Input	ArtNet or sACN	0(00)	Merge
Outlet 2	Input		Ch1	HTP, LTP, Backup, Custom
Outlet 3	Input		1(01)	Disabled
Outlet 4	Input		2(02)	Disabled

Left node configuration

In this example (left node of Illustration 2), the selected mode is “**Merge**”. The second outlet will automatically be set as a merged input. You will not be able to configure a universe address for the second outlet, as the merged result will end at the universe address of the first outlet (primary input). Instead of universe you will be able to set the starting DMX channel address (1-512). This indicates from which channel address the second input has to be merged in. This offset is only available when using **HTP** or **LTP** policies. Those rules will be applied on all channel of the whole universe.

If you choose “**Backup**”, a small blue icon will appears on the left side of “Outlet 2” label; then click on it, a pop up frame appears :



Illustration 3: DMX Input backup merging

This menu lets you choose the backup time (from 400 to 9999ms). This time represents the delay from which the node will automatically switch to the backup outlet when invalid or no DMX is received anymore on the primary outlet.

Tick the box if you want the node to auto-recover as soon as valid data is available again on primary connector.

If you tick off the box, you will have to enable the trigger universe and select a recover channel (page 27).

If you choose “**Custom**” policy, a small blue icon will also appear on the left side of “Outlet 2” label; then click on it, a new pop up frame appears :

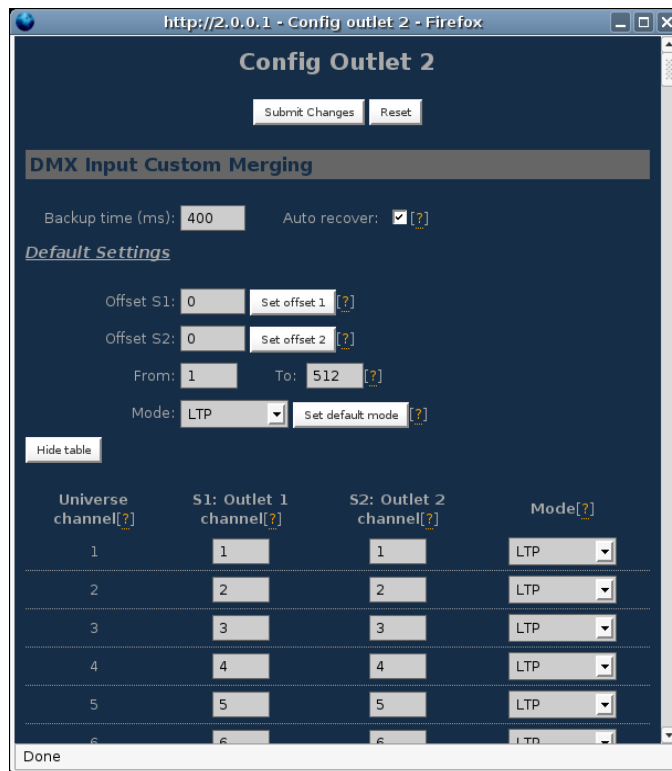

Illustration 4: Custom DMX input merging

Click on “**Show Table**” button to see the complete soft patch available for this outlet.

- **Offset S1 & S2** : Enter a value for the desired offset of the starting channel for outlets 1 or 2; example, for channels 1 to start on the third channel, enter 3.
- **From – To** : this range let you quickly set the policy you need on the channel range of your choice. example, if you need HTP policy on channels 23 to 145, enter 23 in the “**From**” field and “145” in the “**To**” field. Then select the HTP policy in the “**Mode**” drop down list, then press “**Set Default Mode**”.

Notice that following policies are available for each channel:

Zero, HTP, LTP, S1 only (Source 1 only), S2 only (Source 2 only); S1 as Backup (Source 1 as backup), S2 as Backup (Source 2 as Backup).

The left column represent the resulting universe channel number streamed to the network. S1 column represents Source 1 channels and S2 column Source 2 channels. It's thus easy to understand that you can create your own soft patch by entering the channels of your choice in one of theses column.

Once your patch is created, click submit to close the window, then click submit again on the node page to record your settings.

Inputs (IP Merging)

	Direction	Protocol	Universe	Mode	IP Merging
Outlet 1	Output	Artnet or sACN	1(01)	Normal	Disabled
Outlet 2	Input	Artnet or sACN	1(01)	Normal	Backup
Outlet 3	Input		2(02)	Disabled	Disabled
Outlet 3	Input		3(03)	Disabled	Disabled

Right node configuration

This mode can be very useful in such an application.

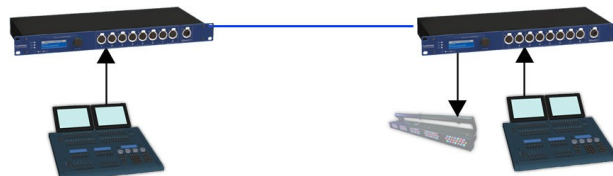

Illustration 5: IP Merging

The right side lighting desk is used as a backup desk on stage. This means that the right side node will automatically switch to that outlet if no Art-Net™ or sACN packets are available on the selected universe (in that case universe 0). Select your backup time in the small pop up frame by clicking the left blue icon, then submit your changes.

Outputs (IP Merging)

	Direction	Protocol	Universe	Mode	IP Merging
Outlet 1	Output			Normal	HTP, LTP, Custom
Outlet 2	Input		1(01)	Disabled	Disabled
Outlet 3	Input		2(02)	Disabled	Disabled
Outlet 4	Input		3(03)	Disabled	Disabled

This mode can be very useful in the case of 2 control sources located in different places in the network wants to control the same DMX device at the same time.

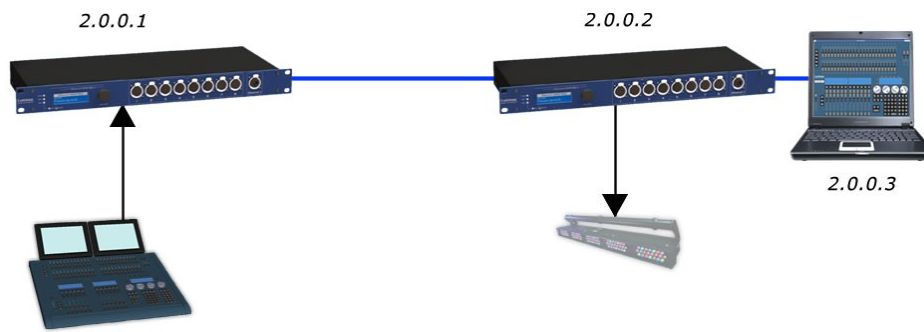

Illustration 6: Output IP merging

In this setup, the right lighting software (S2) is used in the same time as the left lighting desk (S1). Both streams are merged through the final output on the right node.

The IP Merging mode provides the following policies when an outlet is set as output:

- HTP, for all outlet channels. Up to 4 Art-Net™ or sACN sources can be merged.
- LTP, for all outlet channels. Up to 4 Art-Net™ or sACN sources can be merged.
- Custom, to create a complete soft patch, to set merging policy for every single channel by IP source and to use the enhanced trigger system. Two Art-Net™ or sACN can be merged.

If you choose "Custom", click on the blue icon left sided to the "Outlet" label. A pop up frame appears:

DMX Output Custom IP Merging

IP/Universe Settings

IP source 1: Universe: sACN

IP source 2: Universe: ArtNet

Backup time (ms): Auto recover:

Default Settings

Offset S1: Set offset 1

Offset S2: Set offset 2

From: To:

Mode: Set default mode

Trigger Chn: Set default trigger

Output channel <input type="button" value="⌶"/>	Source 1 channel <input type="button" value="⌶"/>	Source 2 channel <input type="button" value="⌶"/>	Mode <input type="button" value="⌶"/>	Trigger <input type="button" value="⌶"/>
1	-	1	S2 Only <input type="button" value="⌵"/>	501
2	-	2	S2 Only <input type="button" value="⌵"/>	501
3	1	3	LTP <input type="button" value="⌵"/>	500
4	2	4	LTP <input type="button" value="⌵"/>	500
5	3	5	LTP <input type="button" value="⌵"/>	500
6	4	6	LTP <input type="button" value="⌵"/>	500
7	5	7	LTP <input type="button" value="⌵"/>	500
8	6	8	LTP <input type="button" value="⌵"/>	500
9	7	9	LTP <input type="button" value="⌵"/>	500
10	8	10	LTP <input type="button" value="⌵"/>	500
11	9	11	LTP <input type="button" value="⌵"/>	500
12	10	12	LTP <input type="button" value="⌵"/>	500
13	11	13	LTP <input type="button" value="⌵"/>	500
14	12	14	LTP <input type="button" value="⌵"/>	500

Illustration 7: DMX Output custom IP merging

You can find in this pop up frame similar features as when using the custom merging on outlets set as inputs (page 19).

The main difference is about the following points :

- **IP Source 1 & 2** : Here you can enter the 2 IP addresses assigned to your 2 control source. In case you don't know one of your source IP address, simply enter 0.0.0.0 in the address field.
- **Universe** : Here you can select the universes number and the protocol streamed by your control sources. This feature is very useful if the 2 sources don't use the same universe number or protocol.
- **Trigger channel.** This feature allows you to remotely change the merging policy of one or several dedicated channels through a single DMX value. From anywhere on the network, you can by example swap from a "LTP" merge to a "S2 only" policy simply by using a different DMX trigger channel value. Enter here the DMX channel you want to use to remotely takeover control of the merging rule. Once you've selected that channel, you'll need to reach the "Global" web page of the node to enable and select your Trigger universe. You'll also need to patch or assign a DMX trigger channel to your control source; here is the DMX chart of the Luminex DMX trigger channel :

0 - 7	Do nothing
8 - 15	Zero out
16 - 23	HTP merge
24 - 31	LTP merge
32 - 39	Source 1 only
40 - 47	Source 2 only
48 - 111	Reserved
112 - 119	Source 1 as backup
120 - 127	Source 2 as backup
128 - 255	Do nothing

Note :Never forget if you control the trigger channel from more than one source to press "Do nothing" once you've selected the desired value. Indeed, if you send 2 different values from 2 different sources for the trigger channel, the node won't stop swapping between those values, what results in a big slowing down of the node processing power.

Recover channel

If you have set one of a node outlet in IP backup mode, the node will swap automatically to this outlet in case of DMX failure from the primary source. Once the primary source is back again available, the node will automatically swap back to that source if set in Auto-recover mode. We all know that it can be useful to decide when to swap back to the primary source (booting time of the desk + loading the right cue in case of desk failure). Tick off the auto-recover box in the pop up window if you decide to work in manual recover mode. Then you'll have to enable the trigger universe in the "Global" Web page and choose a recover channel. You now have the opportunity to choose to recover either each outlet one by one or all outlet in one shot.

Here is the Luminex recover channel DMX chart :

Value	Outputs	Merged Input pairs	Normal Inputs
0 – 7	Do nothing	Do Nothing	Do Nothing
8 – 15	Recover Outlet 1	Recover IP backup	Recover IP backup
16 – 23	Recover Outlet 2	Recover DMX Backup	Recover IP backup
24 – 31	Recover Outlet 3	Recover IP backup	Recover IP backup
32 – 39	Recover Outlet 4	Recover DMX Backup	Recover IP backup
40 – 47	Recover Outlet 5	Recover IP backup	Recover IP backup
48 – 55	Recover Outlet 6	Recover DMX Backup	Recover IP backup
56 – 63	Recover Outlet 7	Recover IP backup	Recover IP backup
64 – 71	Recover Outlet 8	Recover DMX Backup	Recover IP backup
72 – 79	Recover all outlets	Recover All Backup	Recover all backup
80 – 255	Do Nothing	Do Nothing	Do Nothing

All those soft patches can be recorded or loaded from or to the node by using "Load Patch" or "Export patch" buttons. Luminex node recognize .txt files. These are "TAB" seperated files which can be edited using spreadsheet software (Excel, OO Calc,...)

Network settings

Network Settings

IP Settings

ArtNet compliant? [?]

Auto ArtNet: [?]

IP: 2.0.0.8 [?]

Netmask: 255.0.0.0 [?]

Broadcast: 2.255.255.255 [?]

Port (Hex): 1936 [?]

Node Identification

Short name: Ethernet-DMX8MkII [?]

Long name: Ethernet-DMX8 MkII - Node A - Rack Version [?]

IP Settings

You can enter here the desired Art-Net™ IP address and Netmask you want to use. If you're not confident with Art-Net™ IP setting, tick the "Art-Net™ compliant?" box for the node to warn you in case of mistake. Art-Net™ IP addresses usually look like 2.x.x.x or 10.x.x.x.

You're not obliged to work with Art-Net™ IP addresses. If you wish to work with usual IT IP addresses as 192.168.x.x, there's no problem for you to set such address on the node. Please remember that your node will thus not be visible on the network from devices set with conventional Art-Net™ IP addresses (2.x.x.x or 10.x.x.x).

The Port field allows you to change the UDP port used on the network to transmit your UDP Art-Net™ packets. Luminex recommends not to change this value.

Node identification :

Enter here a small and long name to easily identify your node on the network through a Web interface, Art-Net™ compliant softwares or Luminex LumiNet monitor.

- **Global**

Some global settings can be altered by clicking Global in the Setup sub menu. Device Settings

Set Up:: Global Settings

Device Settings

ID No.: 001 [?]
Enable trigger: Universe: 0 (00) [?]
Recover channel: - [?]

DMX Details

DMX framerate: 36 Fps [?]
Break: 184 μs [?]
DMX output time: Continuously [?]

Miscellaneous

Verbose level: Show warnings + errors [?]
Lock mode: No lock [?]
Locking code: **** [?]
Confirm code: **** [?]
Backlight auto off: [?]

Submit Changes Reset

Here you can change the device's ID number which is indicated on LumiNet monitor.

You can also enable the Trigger universe to remotely control your merging policy through any DMX source. The node will listen to the specified universe entered in the universe field.

You can set your Recover channel if you use the manual recovery mode (page 19, 24).

DMX details

The DMX frame rate setting for all outlets. This can be set from 20 to 40 frames per second. Break Time can be set from 176 to 352μs.

DMX Output time can be set to 1 – 10 minutes or continuously. This time sets how long an output remains outputting it's last DMX levels after no valid DMX packet came in for that particular universe on Art-Net™ or SACN.

Miscellaneous

This part is about security and warnings :

- **Verbose level** : Select if you want to see error and warning messages on the front end LCD or through the Web interface.
- **Lock Mode**: select the security level you want to be applied on your Ethernet-DMX8 MkII front end. Auto lock will force the Node to lock the jog after 2 minutes of front end inactivity.

Password protected mode will guide you to set a password into the "locking code" field. Once the node is locked, you'll have to enter the 4 digit password through the Web interface password field. Use "admin" in the login field.

Toolbox

When clicking on Tools in the navigation bar, a sub menu appears. Choose one of the items in the sub menu.

- **Profile manager**

The profile manager is able to store 40 profiles. All profiles are stored on the device.

A preview of the complete configuration stored in a profile is shown when a profile is selected from the drop down list. When an empty profile is selected, no preview will be shown.

Once a profile is selected you can choose to recall it, to save actual settings as a profile, or to delete the profile.

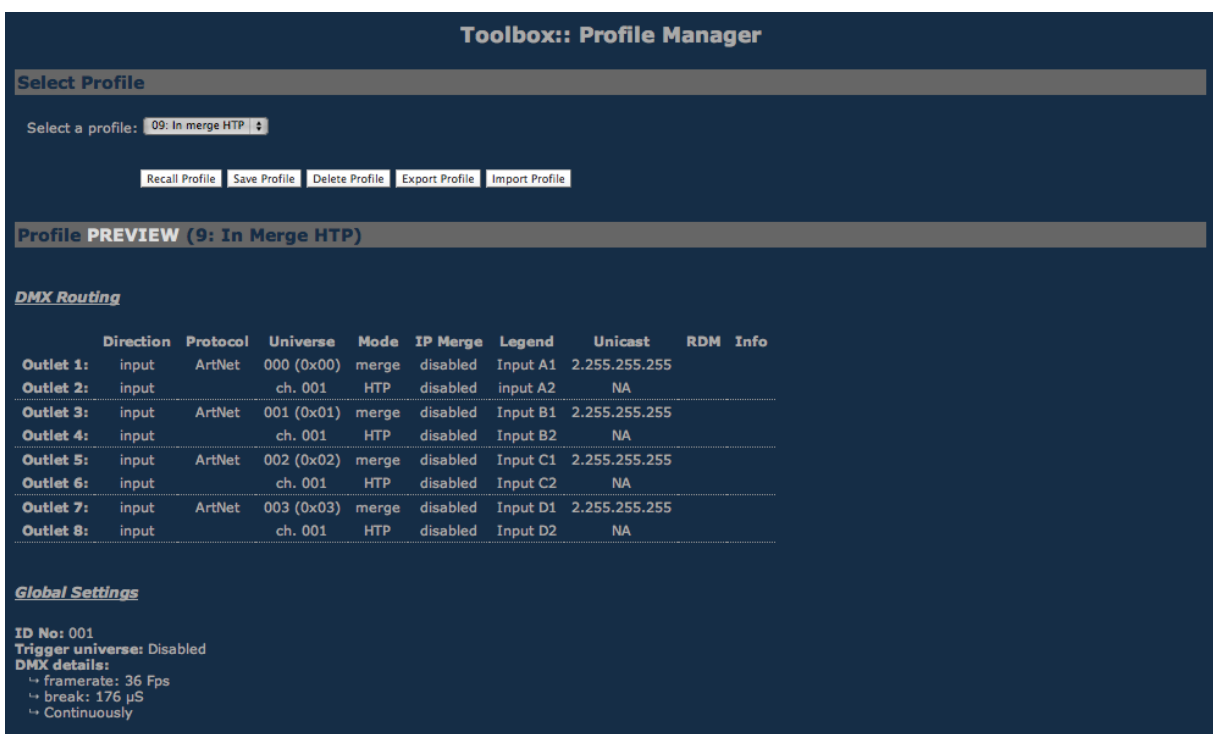

The screenshot displays the 'Toolbox:: Profile Manager' interface. At the top, there is a 'Select Profile' section with a dropdown menu showing '09: In Merge HTP'. Below this are buttons for 'Recall Profile', 'Save Profile', 'Delete Profile', 'Export Profile', and 'Import Profile'. The main area is titled 'Profile PREVIEW (9: In Merge HTP)'. It contains a table for 'DMX Routing' and a section for 'Global Settings'.

	Direction	Protocol	Universe	Mode	IP Merge	Legend	Unicast	RDM	Info
Outlet 1:	input	ArtNet	000 (0x00)	merge	disabled	Input A1	2.255.255.255		
Outlet 2:	input		ch. 001	HTP	disabled	input A2	NA		
Outlet 3:	input	ArtNet	001 (0x01)	merge	disabled	Input B1	2.255.255.255		
Outlet 4:	input		ch. 001	HTP	disabled	Input B2	NA		
Outlet 5:	input	ArtNet	002 (0x02)	merge	disabled	Input C1	2.255.255.255		
Outlet 6:	input		ch. 001	HTP	disabled	Input C2	NA		
Outlet 7:	input	ArtNet	003 (0x03)	merge	disabled	Input D1	2.255.255.255		
Outlet 8:	input		ch. 001	HTP	disabled	Input D2	NA		

Global Settings
ID No: 001
Trigger universe: Disabled
DMX details:
↳ framerate: 36 Fps
↳ break: 176 µS
↳ Continuously

When recalling a profile, an other page will appear to ask whether to recall your network settings as well or only the outlet routings.

When saving a profile a next page will ask you to fill in a profile name.

Snapshot manager

The Ethernet-DMX8 MkII embeds a snapshot function that allows you to capture 3 lighting states (fixed values) per outlet. The snapshot function is only available for outlets set as normal outputs.

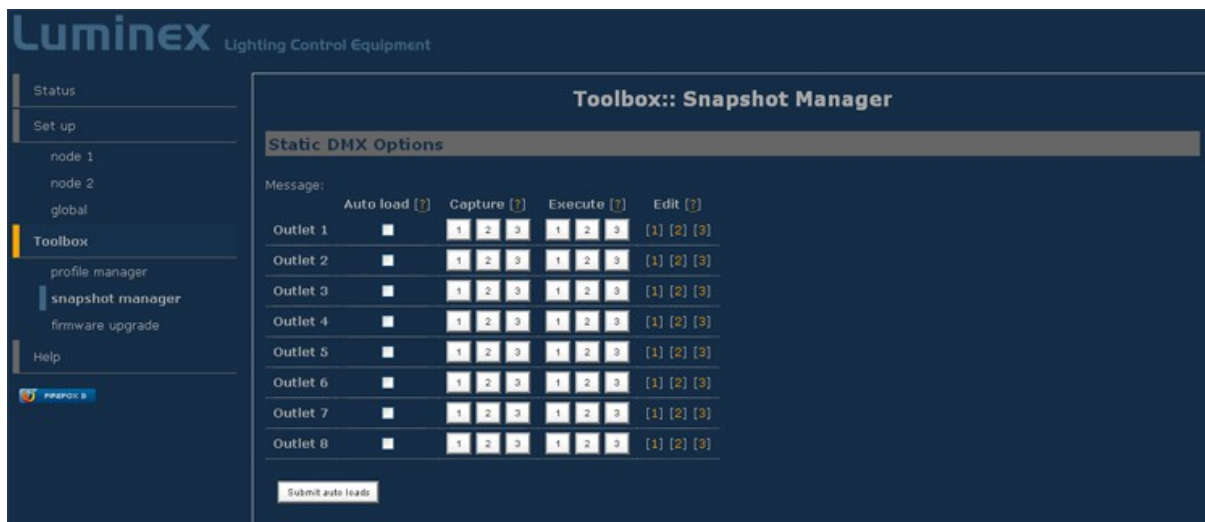

Auto load : When this option is ticked and the outlet is set as a normal output, then the unit will automatically load snapshot 1 at startup of the node. As soon Art-Net™ or sACN data arrives for that output, the DMX output will change. This feature is ideal for use in exhibition or expos.

Capture : Captures actual output state as a static DMX snapshot when there is DMX running on the output. Simply press on one of the 3 captures available to snapshot the DMX output.

Execute : Executes clicked snapshot and sets it on the DMX output when configured as a single output. The execute can't work if the associated universes runs on the network.

Edit : Link to edit captured snapshot in a channel table (see following screenshot). Here you can directly edit and change channel values. You can also directly create your lighting state from that windows by inserting desired values, and recall the snapshot from the Web interface.

Toolbox :: Edit Outlet 1 Snapshot 1

Static DMX Values For Outlet 1 Snapshot 1

Message:

Channel	1	2	3	4	5	6	7	8	9	10
0	0	0	0	0	0	0	0	0	0	0
10	0	0	0	0	0	0	0	0	0	0
20	0	0	0	0	0	0	0	0	0	0
30	0	0	0	0	0	0	0	0	0	0
40	0	0	0	0	0	0	0	0	0	0
50	0	0	0	0	0	0	0	0	0	0
60	0	0	0	0	0	0	0	0	0	0
70	0	0	0	0	0	0	0	0	0	0
80	0	0	0	0	0	0	0	0	0	0
90	0	0	0	0	0	0	0	0	0	0
100	0	0	0	0	0	0	0	0	0	0
110	0	0	0	0	0	0	0	0	0	0
120	0	0	0	0	0	0	0	0	0	0
130	0	0	0	0	0	0	0	0	0	0
140	0	0	0	0	0	0	0	0	0	0
150	0	0	0	0	0	0	0	0	0	0
160	0	0	0	0	0	0	0	0	0	0
170	0	0	0	0	0	0	0	0	0	0

Capture recall

The Ethernet-DMX8 MkII offers a user friendly interface for users to easily recall the recorded snapshots from the Web interface. Type the following address to reach the execute buttons page, where w.x.y.z represents the Ethernet-DMX8 MkII IP address : http://w.x.y.z/cgi-bin/toolbox_outlet.cgi/

For instance:

http://2.212.104.190/cgi-bin/toolbox_outlet.cgi/

Toolbox:: Snapshot Manager

Static DMX Options

Message:

Execute [?]

Outlet 1	1	2	3
Outlet 2	1	2	3
Outlet 3	1	2	3
Outlet 4	1	2	3
Outlet 5	1	2	3
Outlet 6	1	2	3
Outlet 7	1	2	3
Outlet 8	1	2	3

- **Firmware upgrade**

The firmware upgrade page allows you to select a downloaded firmware file and upload it to the device.

This page shows the actual firmware version running on the unit below the file upload field.

The latest firmware file can always be downloaded from the Luminex web pages.

[Http://www.luminex.be](http://www.luminex.be)

To install the firmware on the Ethernet-DMX8 MkII follow these steps:

1. Download the .zip file and save it on your hard disk.
2. Extract the .zip file.
3. Please read the "ChangeNote.txt" for latest release changes.
4. Browse to the device its IP address with your favorite web browser.
5. Click Toolbox -> Firmware upgrade.



6. Browse to the extracted upgrade file on your hard disk (ethdmx8mkii_v4.X.X.bin), where X.X represents firmware version.
7. Select the file and press on the "Upgrade" button.
8. The upgrade file will be sent to the device. The following message appears on the front end display:

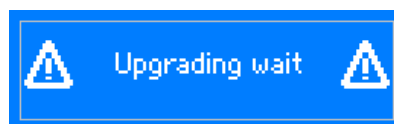

9. The unit will then reboot after the upgrade procedure and will display the following message on front end display:

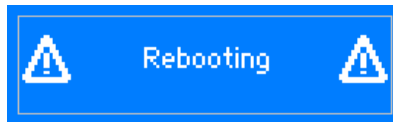

10. Wait until the device has rebooted. (until then the Power/Ok LED will be blinking). A solid Power/Ok LED on indicates your Ethernet-DMX8 MkII has been properly updated.
11. Click now on Toolbox -> Firmware upgrade if the current version is set to the right version number. If the number is the same as mentioned with the file then the upgrade succeeded.

Troubleshooting

- **The Power/OK LED is always blinking:**

Your Ethernet-DMX8 MkII doesn't boot properly. Restart the unit with the power switch. If this doesn't help, contact your local dealer. Please note the Power/OK LED will be blinking during upgrade procedure, don't switch off the power during this step.

- **My computer is connected to the node, but the Link/Activity LED is still off.**

Check the Ethernet cable you're using, and check that each RJ45 on each side of the cable is properly inserted. Feel free to plug another cable to isolate the problem.

- **I can't reach the Web interface of the Ethernet-DMX8 MkII**

Please check first the two previous steps. Then please be sure your computer is set in the same IP range than your Ethernet-DMX8 MkII. Try to ping the unit with a dedicated application, such as a DOS session on Windows, or a terminal session on MAC. You can use LumiNet Monitor V2 to discover your Ethernet-DMX8 MkII. If you can't see your device in LumiNet Monitor V2, please contact your local dealer.

Additional Documentation

All additional documentation can be downloaded from our web pages in the support section.

[Http://www.luminex.be](http://www.luminex.be)

--> Support

Credits:

Art-Net™ is a trade mark of Alderamin Group Ltd. The Art-Net protocol and associated documentation is copyright Alderamin Group Ltd.