

LIVEPREMIER USER MANUAL (V4.4)

References:

AQL-RS-ALPHA, AQL-RS1, AQL-RS2,

AQL-RS3, AQL-RS4, AQL-RS5, AQL-RS6,

AQL-C, AQL-C+, AQL-Cmax



ANALOG WAY®

Date : 01/04/2025

License Information contained in this document, in particular data, pictures, information, trademarks and logos are exclusive property of Analog Way and are protected by copyrights and other intellectual property rights.

2025, Analog Way, all rights reserved – 04/2025

Any representation and/or reproduction, in part or in full, is prohibited and would be considered a violation of Analog Way's copyright and other intellectual property rights.

Visual representations (diagrams, photos, icons, pictograms, screenshots, spare parts, etc.) are not contractual.

Table of contents

1. Disclaimer	14
1.1. Copyrights	14
1.2. Warranty	14
1.3. Liability	14
1.4. Force Majeure	14
2. Hardware Specifications	15
2.1. General safety instructions	15
2.1.1. English	15
2.1.2. French	16
2.1.3. Italian	18
2.1.4. German	20
2.1.5. Spanish	21
2.1.6. Finnish	23
2.1.7. Swedish	25
2.1.8. Norwegian	26
2.1.9. Symbols on product identification and warning labels	27
2.1.10. Environmental specifications for all LivePremier models	29
2.1.11. UPS compatibility	30
2.2. Package Contents	31
2.3. Rack mount information	31
3. Introducing LivePremier™	32
3.1. Modular architecture	32
3.2. Supported formats and rates	33
3.3. Front panel	33
3.4. Rear panels	34
3.5. Input / Output cards	34
3.5.1. Available cards	35
3.5.2. Change an input / output card	36
3.6. Fixed parts	37
3.6.1. Optional control card with DisplayPort Multiviewer outputs	37
3.6.2. USB and sync ports	38
3.6.3. Framelock	38
3.6.4. GPIO	38
3.6.5. Dante audio connectors	38
3.6.6. Power supply units (PSU)	38
3.6.6.1. Power supply compatibility	39
3.6.6.2. Power supply noise on standby	39
3.6.6.3. Power supply noise on start up	39

3.7. Accessories	39
3.7.1. HDMI 2.0 over fiber extenders – Transmitter and Receiver	40
3.7.2. Rack-mountable power tray for optical extenders	40
3.8. Precautions when mounting a LivePremier unit	40
3.9. Powering on and off	41
3.9.1. Start the LivePremier unit	41
3.9.2. Power off the LivePremier unit	41
3.9.3. Forced shutdown	41
3.10. Firmware update	42
4. Using the Web RCS	43
4.1. Run the Web RCS	43
4.1.1. Web RCS requirements	43
4.1.2. Default network settings	44
4.1.3. Connection	44
4.1.4. Login page	45
4.1.5. LivePremier Simulator	45
4.2. General tips	45
4.2.1. Web browser features	45
4.2.2. Mobile version	46
4.2.3. Section buttons (copy, paste and reset)	46
4.2.4. Setting a number value	46
4.2.5. Search bar	47
4.2.6. Alarms and notifications	47
4.2.7. Standby / Restart	47
4.2.8. Back panel shortcuts	48
4.3. Device overview – system settings	48
4.3.1. Device	49
4.3.2. Firmware	49
4.3.2.1. Update	49
4.3.2.2. Reinstall current Firmware	50
4.3.3. Network	50
4.3.4. Power	50
4.3.5. Hardware	51
4.3.6. Cooling	51
4.3.7. Remote Access	51
4.3.7.1. Default Web RCS password	51
4.3.7.2. Enable Web RCS password protection	51
4.3.7.3. Lock an opened Web RCS session	52
4.3.7.4. Change Web RCS password	52
4.3.7.5. Reset Web RCS password from the front panel	52
4.3.7.6. Enable / Disable HTTP and HTTPS on the Web RCS	52
4.3.7.7. Import custom HTTPS certificate	53

4.3.7.8. Reset HTTP and HTTPS settings	53
4.3.8. Remote Control	53
4.4. Save / Reset / Load Configuration	54
4.4.1. Save the current Configuration	54
4.4.2. Reset a Configuration	54
4.4.3. Load a Configuration	55
4.5. Device control synchronization	55
4.5.1. Web RCS synchronization	56
4.5.2. RC400T synchronization	56
5. LivePremier concepts	57
5.1. Capacity	57
5.1.1. Standard formats capacity	57
5.1.2. Elements using capacity	58
5.1.3. Content and layer compatibility	58
5.2. Screen layers	59
5.2.1. Screen sources	59
5.2.2. Mixing layers	60
5.2.3. Split layers	60
5.3. Aux Screens and Aux layers	60
5.3.1. Aux layers quantity and capacity	61
5.3.2. Aux layers limitations	61
5.4. Screen / Aux Screen comparison	62
5.5. LivePremier Processing	62
5.5.1. VPUs and Scaling engines	62
5.5.2. Self-rearrangement	63
5.5.3. VPU capacities support	63
5.5.4. Scaling engine boundary	64
5.5.5. Combined VPUs	64
5.5.6. Optimized mode	65
5.5.7. Cut & Fill resources	66
5.5.8. How many VPUs per model?	67
5.5.9. IPUs	67
5.6. HDR conversion	68
5.7. LivePremier latency	69
6. Preconfig Menu	70
6.1. Preconfig > System	70
6.1.1. Vertical rate	71
6.1.1.1. Set defined rate	71
6.1.1.2. Set relative rate	71
6.1.2. Framelock input settings	71

6.1.3. Framelock output settings	72
6.1.4. Color processing	72
6.1.5. Quick HDCP	72
6.2. Preconfig > Multiviewers	73
6.2.1. Multiviewer	73
6.2.2. Multiviewers quantity	73
6.2.3. Set a DPH104 for a Multiviewer DP output	73
6.3. Preconfig > Outputs	74
6.3.1. Output capacity – The 4-4 rule	74
6.3.2. Output group	75
6.3.3. Set an output group for a Screen	76
6.3.4. Set a DPH104 output for a Screen	76
6.3.5. Set an output for an Aux Screen	77
6.3.6. Output cloning and Aux output duplicate	77
6.3.6.1. Output cloning	77
6.3.6.2. Aux output duplication	78
6.3.7. Creating Screens	79
6.3.7.1. Screen regions	79
6.3.7.2. Create a Screen	79
6.3.7.3. Create a Screen with no layers	81
6.3.8. Create an Aux Screen	81
6.3.9. Rename a Screen	82
6.4. Preconfig > Canvas	82
6.4.1. Set output rotation	83
6.4.2. Patterns	86
6.4.2.1. Screen pattern	87
6.4.2.2. Output pattern	87
6.4.3. Grid canvas	87
6.4.3.1. Create a Grid canvas	87
6.4.3.2. Create a covering in Grid canvas (blending)	88
6.4.3.3. Create a gap in Grid canvas (bezel)	88
6.4.4. Free canvas	89
6.4.4.1. Bottom bar buttons – Output position	89
6.4.4.2. Create a canvas in Auto mode	89
6.4.4.3. Create a canvas in Custom mode	90
6.4.4.4. Create a covering in Free canvas (blending)	90
6.4.4.5. Preview regions and layers in Canvas	91
6.4.5. Advanced output settings (in Preconfig > Canvas)	91
6.4.5.1. Canvas settings for DPH104	91
6.4.5.2. Create an area of interest (AOI)	91
6.4.5.3. Pitch compensation	92

6.5. Preconfig > Inputs	92
6.5.1. Input group	92
6.5.2. Set an input group	93
6.5.3. Set four 3G-SDI inputs for 2SI format	94
6.5.4. Set an NDI input	94
6.5.5. Set an input visibility	95
6.6. Preconfig > Images	95
6.6.1. Image slots	95
6.6.2. Set images preset capacity	96
6.6.3. Set images visibility	96
6.7. Preconfig > Backgrounds	96
6.7.1. Background sets	96
6.7.2. Background set for a Screen with one output group	97
6.7.3. Background set for a Screen with multiple output groups	97
6.7.4. Reset a background set	98
6.7.5. Remove a source from all background sets	98
6.8. Preconfig > AVoIP	98
6.8.1. IP/SDI	98
6.8.1.1. Define IP/SDI card network	99
6.8.1.2. Find NDI sources	99
6.8.1.3. Assign a source to an input	99
6.8.2. SDVoE	100
6.8.3. Dante	100
7. Multiviewers	101
7.1. Multiviewers settings	101
7.2. Multiviewers format	101
7.3. Multiviewers signal	102
7.4. Multiviewers adjustment (image correction)	102
7.5. Multiviewers pattern	103
8. Outputs	104
8.1. Outputs main screen	104
8.2. Output settings	105
8.2.1. Output format	106
8.2.2. Output signal	106
8.2.3. Output adjustment (manual image correction)	108
8.2.4. Output adjustment using Correction LUT	108
8.2.5. Output pattern	108
9. Inputs	110
9.1. Inputs main screen	110
9.2. Input settings	111
9.2.1. Input signal	111

9.2.2. Input aspect	112
9.2.2.1. Set input aspect ratio	113
9.2.2.2. Set input crop	113
9.2.3. Input keying	113
9.2.3.1. Set Chroma Keying	114
9.2.3.2. Set Luma Keying	114
9.2.3.3. Keying using a CremaTTe 3D LUT from the Library	115
9.2.3.4. Set Cut & Fill	115
9.2.4. Input adjustment (manual image correction)	116
9.2.5. Input adjustment using LUT Correction	116
9.2.6. Input pattern	116
9.2.7. Input NDI source	117
10. Images and Library	118
10.1. Library	118
10.1.1. Image formats	119
10.1.2. Image specifications	119
10.1.3. Transfer images from the computer to the unit	119
10.1.4. Capture a video signal into an image file	119
10.1.5. Download an image file from the unit	120
10.1.6. Upload an image file to the unit	120
10.1.7. Delete an image file from the unit	120
10.1.8. Manage Image Library from the front panel	120
10.2. Images	121
10.2.1. Images main screen	121
10.2.2. Image slots settings	121
10.2.3. Downscale to capacity	122
10.2.4. Assign an imported image to an image slot	122
10.2.5. Assign a timer to an image slot	122
10.2.6. Image signal	123
10.2.7. Image aspect	123
10.2.7.1. Set image aspect ratio	123
10.2.7.2. Set image crop	124
11. Formats and EDID	125
11.1. Formats	125
11.1.1. Create a custom format	125
11.1.2. Edit a custom format	126
11.1.3. Delete a custom format	126
11.2. EDID	126
11.2.1. EDID bank	127
11.2.2. Save an EDID from inputs and outputs	127
11.2.3. Replace an Input EDID with an EDID from the bank	127
11.2.4. Set a template format for an EDID	127

11.2.5. Set a custom format for an EDID	127
11.2.6. Export an EDID to computer	128
11.2.7. Import an EDID from computer	128
11.2.8. Delete a custom EDID	128
11.2.9. AW EDID Editor	129
12. LUT Libraries	130
12.1. Creating a CremaTTe 3D LUT using a LivePremier live input	130
12.2. Importing a LUT	131
12.3. Using a LUT	131
12.4. Export a LUT to computer	131
12.5. Delete a LUT	131
13. Audio, Timers and GPIO	132
13.1. Audio	132
13.1.1. Audio routing	132
13.1.2. Default audio routing	133
13.1.3. Advanced audio routing (single channel)	133
13.2. Timers	134
13.2.1. Create a timer	134
13.2.2. Control counter timers in Live menus	134
13.2.3. Use timers in Screens and Aux. Screens	135
13.3. GPIO	136
13.3.1. Pins table and GPIO connection	136
13.3.2. On/Off switch pins	137
13.3.3. Set GPIO in the Web RCS	137
14. Screens / Aux.	139
14.1. Screens menu interface	139
14.1.1. Program and Preview	139
14.1.2. Views	140
14.1.2.1. View filters – Top bar buttons	140
14.1.2.2. Resize and reorder Screen windows	140
14.1.2.3. Save a view memory	140
14.1.2.4. Load / edit a view memory	141
14.1.2.5. Rename, hide or delete a view memory	141
14.1.3. Sources - Left panel	141
14.1.4. Layer selection	142
14.1.5. Screen layout editor	143
14.1.6. PGM and PRW buttons – Screen controls	144
14.1.7. Bottom bar buttons	144
14.1.8. Transitions - Right panel	146
14.2. Layer properties	147
14.2.1. Layer selection and tools	147

14.2.2.	Layer position and size	148
14.2.2.1.	Set layer position with the layout editor	148
14.2.2.2.	Set layer position and size manually	148
14.2.3.	Layer source	149
14.2.3.1.	Assign content to a layer	149
14.2.3.2.	Select NDI source for a layer	149
14.2.3.3.	Set a colored layer	150
14.2.3.4.	Assign content to a Screen backgrounds	150
14.2.3.5.	Set a colored background	150
14.2.3.6.	Remove a content from a layer	150
14.2.4.	Cut & Fill effect	151
14.2.4.1.	Resource used by Cut & Fill	151
14.2.4.2.	Set Cut & Fill in layer	151
14.2.5.	Set layer opacity	152
14.2.6.	Set layer crop and aspect	152
14.2.7.	Set layer mask	152
14.2.8.	Set layer border	153
14.2.9.	Set layer smooth border	153
14.2.10.	Set layer shadow	153
14.2.11.	Set layer color filter	154
14.2.12.	Set layer Horizontal and Vertical flip	154
14.3.	Layer transition	154
14.3.1.	Set layer transition effect	154
14.3.2.	Set layer transition timing	155
14.3.3.	Set layer transition speed	155
14.4.	Aux Screens	155
15.	Memories	157
15.1.	Memories tab	157
15.2.	Master Memories	158
15.2.1.	Save a Master Memory from current Screens	158
15.2.2.	Save a Master Memory from existing Screen Memories	159
15.2.3.	Load a Master Memory	160
15.2.4.	Load a Master Memory at startup	161
15.2.5.	Edit a Master Memory	161
15.3.	Screen Memories	161
15.3.1.	Save a Screen Memory	161
15.3.2.	Load a Screen Memory	162
15.3.3.	Edit a Screen Memory	163
15.3.4.	Quick overwrite or revert	163
15.4.	Layer Memories	163
15.4.1.	Save a Layer Memory	163

15.4.2. Load a Layer Memory	164
15.4.3. Edit a Layer Memory	164
15.5. Rename a Memory	165
15.6. Change the color of a Memory slot	165
15.7. Reorder Memories	165
15.8. Delete a Memory	166
16. Multiviewers	167
16.1. Tips and recommendations	167
16.2. Multiviewers menu interface	167
16.2.1. Sources - Left panel	168
16.2.1.1. Control counter timers in Multiviewers	168
16.2.1.2. Set Preview mode for Preview Screen widgets	169
16.2.2. Widget selection	170
16.2.3. Multiviewer layout editor	170
16.2.4. Bottom bar buttons	171
16.3. Widget properties	172
16.3.1. Widget position and size	172
16.3.1.1. Set widget position with the layout editor	172
16.3.1.2. Set widget position and size manually	172
16.3.1.3. 2x2 Slicer mode with DPH104	173
16.3.2. Widget source - Assign content to a widget	173
16.4. Multiviewers memories	173
16.4.1. Save a Multiviewer memory	174
16.4.2. Load a Multiviewer memory	174
16.4.3. Load a Multiviewer memory at startup	174
16.4.4. Edit a Multiviewer memory	174
16.4.5. Rename a Memory	175
16.4.6. Change the color of a Memory slot	175
16.4.7. Reorder memories	175
17. User Maintenance and Troubleshooting	176
17.1. User Maintenance – Air filter	176
17.2. Troubleshooting	176
18. Appendix: RC400T	178
18.1. Installation	178
18.2. Controller description	179
18.3. Getting started	181
18.3.1. Start the RC400T	181
18.3.2. Turn the RC400T off	181
18.3.3. Configure the RC400T network	181
18.3.4. Control multiple units with the RC400T	181
18.3.5. Firmware upgrade	182

18.3.6. Reset to default values	182
18.3.7. Enable / Disable the T-bar	182
18.4. LivePremier control with RC400T	182
18.4.1. Lock / Unlock the screen	182
18.4.2. Select a row mode	183
18.4.3. Layer selection	183
18.4.4. Assign a source to a layer	184
18.4.5. Remove a source from a layer	184
18.4.6. Set a layer position and size	185
18.4.7. Set a layer crop	185
18.4.8. Set an input crop	186
18.4.9. Load a Layer memory	186
18.4.10. Load a Screen memory	186
18.4.11. Load a Master memory	187
18.4.12. Screen selection for Transitions	187
18.4.13. Load a Multiviewer memory	187
18.4.14. Save a Master Memory	187
18.4.15. Save a Screen Memory	188
18.4.16. Save a Layer Memory	188
18.4.17. Delete a memory	188
18.4.18. Button color guide	188
18.4.19. Virtual RC400T	190
19. Appendix: Other LivePremier control options	191
19.1. Use the Shot Box ² and Control Box ³ with LivePremier	191
19.2. Use the Stream deck with LivePremier	192
20. Appendix: LINK	193
20.1. Link setup	193
20.1.1. Installation	194
20.1.2. Configuration	195
20.2. Share setup	196
20.2.1. Shared sources setup	196
20.2.2. Global Multiviewer setup	196
20.2.3. Multi-chassis Screen setup	197
20.2.4. Settings	198
20.3. Linked system settings	198
20.3.1. Framelock	198
20.3.2. Firmware update	198
20.3.3. Configuration import / export	199
20.3.4. Reset modes	199
20.3.5. Power on and off	199
20.3.6. Front panel	199
20.4. Navigation	200

20.4.1. Screens display	200
20.4.2. Sources display	200
20.5. Controllers	201
20.6. Link troubleshooting	201
21. Contact information	203
Glossary	204

1. Disclaimer

The information in this document is subject to change without notice, while every effort is made to be accurate. Analog Way cannot be held liable for any kind of loss whatsoever that may be caused by the use of or reliance in this manual.

1.1. Copyrights

The software installed in the LivePremier remains the sole property of Analog Way unless stated otherwise in a separate licensing agreement. Any attempt to copy or alter the software is prohibited and will render any warranties void.

1.2. Warranty

The LivePremier has been tested in various applications and is deemed to be suitable for uses described in this manual. This product is provided "as is", including all or any 'perceived' or possible faults. The Licensor grants no warranty regarding the utility or contents of the software. Analog Way will warrant the hardware for three years from the date of purchase on parts and labor. Broken connectors are not covered by warranty. The method of warranty is Return to Base (transport costs from and to us are the owner's responsibility). In case of hardware fault please contact your local distributor or us (www.analogway.com). While not an exhaustive list, the following are provided for guidance. Warranty claims will be invalidated in these circumstances:

- A hardware failure is caused by inappropriate handling of hardware such as dropping the image processor, using the image processor without proper ventilation, exposing the unit to water, other liquids or dust.
- The software has been loaded or there has been an attempt to load software onto the unit in any way other than described in the manual or recommended by Analog Way.
- The hardware has been modified by someone other than a certified Analog Way dealer.

1.3. Liability

Analog Way shall not be liable for any loss or damage, be it direct or indirect in regard to the utility or contents of the software or hardware, except to the extent provided by law. Notwithstanding the above, liability for indirect, special, incidental or consequential loss or damage that may arise in respect of the software or hardware, is expressly excluded.

1.4. Force Majeure

Liability of Analog Way is excluded in all cases that constitute Force Majeure circumstances, namely, circumstances beyond the control of Analog Way.

2. Hardware Specifications

2.1. General safety instructions

2.1.1. English

All of the safety and operating instructions should be read before the product is operated and should be maintained for further reference. Please follow all of the warnings on this product and its operating instructions.

- **WARNING:** Not suitable for children. To prevent the risk of electric shock and fire, do not expose this device to rain, humidity or intense heat sources (such as heaters and direct sunlight). This equipment is not suitable for use in locations where children are likely to be present.
- **INSTALLATION:** Slots and openings in the device are provided for ventilation and to avoid overheating. Make sure the device is never placed near a textile surface that could block the openings. Also keep away from excessive dust, vibrations and shocks.
- **POWER:** Only use the power supply indicated on the device of the power source. Devices equipped with a grounding plug should only be used with a grounding type outlet. In no way should this grounding be modified, avoided or suppressed. Connection of equipment to main supply must be after branch circuit breaker of the building installation.



For equipment identified with the symbols above, only an instructed person is allowed to connect and disconnect mains cable from the unit. Grounding is mandatory before plug connection.

Use a grounding cable to connect a screw on the unit chassis to ground.

- **POWER CORD:** The device is equipped with one or multiple detachable power cords.



A device identified with the symbol above indicates that the equipment has multiple power cords. To remove mains, an instructed person shall disconnect all power cords at appliance power inlet.

Caution

The power cords constitute the only mean to completely disconnect the equipment from the main power.

For equipment equipped with multiple power cords: To remove power from product, always disconnect each power cord at appliance inlet. It is not allowed to connect them to intermediate terminal between product and plug in the wall that could be used to disconnect several power supplies giving access to live parts at a point where mains was disconnected.

Use the following guidelines:

- The equipment connected to the network must have a release system easily accessible and located outside the unit.
- Unplug the power from mains if the device is not used for a few days or more.
- To unplug the power cords; do not pull on the power cords but always on the plug itself.
- The outlet should always be near the device and easily accessible.
- Power supply cords should be routed so that they are not likely to be walked on or pinched by items placed upon or against them.

If one of the power supply cords is damaged, unplug the device. Using the device with a damaged power supply cord may expose your device to electric shocks or other hazards. Verify the condition of the power supply cords periodically. Contact your dealer or service center for replacement if damaged.

• **CONNECTIONS:** All inputs and outputs (except for the power input) are Electrical energy source class 1 (ES1) as defined in IEC/UL 62368-1.

ES1 limits: 60Vdc or 30V rms/ 42.4V peak.

• **SERVICING:** Disconnect all power supply cords from main before servicing.

According to IEC 62368-1 standard, an instructed person is authorized to:

- Open the front panel cabinet and clean the air filter (depending on the model)
- Change a removable power supply (depending on the model)

The fuse(s) present in the unit have not been designed to be replaceable.

Do not attempt to service this product yourself by opening or removing covers and screws since it may expose your device to electric shocks or other hazards. The internal Lithium cell battery is not replaceable. In case of a problem, contact your supplier or Analog Way.

• **OPENINGS:** Never push objects of any kind into this product through the openings. If liquids have been spilled or objects have fallen into the device, unplug it immediately and have it checked by a qualified technician.

2.1.2. French

Afin de mieux comprendre le fonctionnement de cet appareil nous vous conseillons de bien lire toutes les consignes de sécurité et de fonctionnement avant utilisation. Conservez les instructions de sécurité et de fonctionnement afin de pouvoir les consulter ultérieurement. Respectez toutes les consignes marquées dans la documentation, sur le produit et sur ce document.

• **ATTENTION :** Ne convient pas aux enfants. Afin de prévenir tout risque de choc électrique et d'incendie, ne pas exposer cet appareil à la pluie, à l'humidité ou à des sources de chaleur intense. Cet équipement ne convient pas pour une utilisation dans des endroits où des enfants sont susceptibles d'être présents.

• **INSTALLATION :** Veillez à assurer une circulation d'air suffisante pour éviter toute surchauffe à l'intérieur de l'appareil. Ne placez pas l'appareil sur ou à proximité d'une surface textile susceptible d'obstruer les orifices de ventilation. N'installez pas l'appareil à proximité de sources de chaleur comme un radiateur ou une poche d'air chaud, ni dans un endroit exposé au rayonnement solaire direct, à des poussières excessives, à des vibrations ou à des chocs mécaniques. Ceci pourrait provoquer un mauvais fonctionnement et un accident.

• **ALIMENTATION :** Ne faire fonctionner l'appareil qu'avec la source d'alimentation indiquée sur l'appareil. Les appareils doivent être obligatoirement connectés sur une source équipée d'une mise à la terre efficace.

En aucun cas cette liaison de terre ne devra être modifiée, contournée ou supprimée. Raccordement des équipements à l'alimentation principale doit être postérieur au disjoncteur de branchement de l'installation électrique du bâtiment.



Pour les équipements identifiés avec les symboles ci-dessus, seule une personne avertie est autorisée à brancher ou débrancher l'appareil. Une mise à la terre est obligatoire avant branchement. Utiliser un câble de terre pour relier une vis du châssis de l'appareil à la terre.

• **CORDON D'ALIMENTATION** : L'appareil est équipé d'un ou plusieurs cordons d'alimentation détachables.



Un appareil identifié avec le symbole ci-dessus indique que l'équipement possède plusieurs cordons secteur. La mise hors tension doit être effectuée par une personne avertie en débranchant tous les cordons de l'appareil.

Attention

Les cordons d'alimentation constituent le seul moyen de débrancher l'appareil totalement de l'alimentation secteur.

Pour les équipements munis de plusieurs cordons secteur : Pour débrancher l'appareil, toujours déconnecter

chaque cordon au niveau du connecteur d'alimentation. Il est interdit d'utiliser une multiprise pour relier les cordons entre l'équipement et une prise murale car la déconnexion de plusieurs alimentations en même temps peut rendre accessible une tension dangereuse au niveau du connecteur qui a été débranché de la prise murale.

Appliquer les consignes suivantes :

- Le matériel relié à demeure au réseau, doit avoir un dispositif de sectionnement facilement accessible qui doit être incorporé à l'extérieur de l'appareil.
- Débrancher les cordons d'alimentation de la prise murale si vous prévoyez de ne pas utiliser l'appareil pendant quelques jours ou plus.
- Pour débrancher les cordons, tirez-les par la fiche. Ne tirez jamais sur les cordons proprement dit.
- La prise d'alimentation doit se trouver à proximité de l'appareil et être aisément accessible.
- Ne laissez pas tomber le cordon d'alimentation et ne posez pas d'objets lourds dessus.

Si un des cordons d'alimentation est endommagé, débranchez-le immédiatement de la prise murale. Il est dangereux de faire fonctionner un appareil avec un cordon endommagé ; un câble abîmé peut provoquer un risque d'incendie ou un choc électrique. Vérifiez les câbles d'alimentation de temps en temps. Contactez votre revendeur ou le service après-vente pour un remplacement.

• **CONNEXIONS** : Toutes les entrées et sorties (exceptée l'entrée d'alimentation) sont des sources d'énergie électrique de classe 1 (ES1) tel que défini dans IEC/UL 62368-1.

Limites de ES1 : 60Vdc ou 30V rms/ 42.4V pic.

- **RÉPARATION ET MAINTENANCE** : Débrancher les cordons d'alimentation avant toute maintenance.

Selon la norme IEC 62368-1, une personne avertie est autorisée à :

- Ouvrir la face avant pour nettoyer le filtre à air (dépend du modèle)
- Changer un bloc d'alimentation accessible de l'extérieur (dépend du modèle)

Le ou les fusibles présents dans l'appareil n'ont pas été conçus pour être remplaçables.

L'utilisateur ne doit en aucun cas essayer de procéder aux opérations de dépannage, car l'ouverture des appareils par retrait des capots ou de toutes autres pièces constituant les boîtiers ainsi que le dévissage des vis apparentes à l'extérieur, risquent d'exposer l'utilisateur à des chocs électriques ou autres dangers.

La pile bouton au Lithium présente à l'intérieur de la machine n'est pas remplaçable. En cas de problème, contactez le service après-vente, votre revendeur ou adressez-vous à un personnel qualifié uniquement.

- **OUVERTURES ET ORIFICES** : Les appareils peuvent comporter des ouvertures (aération, fentes, etc.), veuillez ne jamais y introduire d'objets et ne jamais obstruer ses ouvertures. Si un liquide ou un objet pénètre à l'intérieur de l'appareil, débranchez immédiatement l'appareil et faites-le contrôler par un personnel qualifié avant de le remettre en service.

2.1.3. Italian

Allo scopo di capire meglio il funzionamento di questa apparecchiatura vi consigliamo di leggere bene tutti i consigli di sicurezza e di funzionamento prima dell'utilizzo. Conservare le istruzioni di sicurezza e di funzionamento al fine di poterle consultare ulteriormente. Seguire tutti i consigli indicati su questo manuale e sull'apparecchiatura.

- **ATTENZIONE**: Questo apparecchio non e' adatto all'utilizzo da parte di bambini. Al fine di prevenire qualsiasi rischio di shock elettrico e d'incendio, non esporre l'apparecchiatura a pioggia, umidità e a sorgenti di eccessivo calore. Questo apparato non e' adatto all'utilizzo in luoghi dove ci siano presenti bambini.
- **INSTALLAZIONE**: Assicuratevi che vi sia una sufficiente circolazione d'aria per evitare qualsiasi surriscaldamento all'interno dell'apparecchiatura. Non collocare l'apparecchiatura in prossimità o su superfici tessili suscettibili di ostruire il funzionamento della ventilazione. Non installate l'apparecchiatura in prossimità di sorgenti di calore come un radiatore o una fuoruscita d'aria calda, né in un posto esposto direttamente ai raggi del sole, a polvere eccessiva, a vibrazioni o a shock meccanici. Ciò potrebbe provocare un erroneo funzionamento e un incidente.
- **ALIMENTAZIONE**: Far funzionare l'apparecchiatura solo con la sorgente d'alimentazione indicata sull'apparecchiatura. Le apparecchiature queste devono essere obbligatoriamente collegate su una sorgente fornita di una efficiente messa a terra. In nessun caso questo collegamento potrà essere modificato, sostituito o eliminato. Connessione delle apparecchiature alla rete elettrica deve essere successiva interruttore di circuito dell'impianto dell'edificio.



Per apparecchiature identificate con i simboli sopra, solo una persona abilitata è autorizzata a collegare o scollegare i cavi. Collegare la terra prima di collegarla all'alimentazione. Utilizzare un cavo di terra per mettere a terra la vite del telaio dell'unità.

- **CAVO DI ALIMENTAZIONE**: Il dispositivo è dotato di uno o più cavi di alimentazione removibile.



Un dispositivo identificato con il simbolo sopra indica che l'apparecchiatura dispone di più cavi di alimentazione. Per rimuovere le alimentazioni, una persona abilitata dovrà scollegare i cavi dalla presa di corrente.

⚠ Attenzione

i cavi di alimentazione sono l'unico di disconnettere l'apparecchio all'alimentazione.

Per dispositivo dotato di più cavi di alimentazione: per scollegare il prodotto staccare sempre ogni cavo di alimentazione dalla presa di corrente. Non è consentito utilizzare una ciabatta tra l'apparecchio e la presa a muro, poiché la disconnessione di più alimentatori allo stesso tempo potrebbe rendere accessibile una tensione pericolosa al connettore che è stato scollegato dalla presa a muro.

Seguire le istruzioni istruzioni seguenti:

- Il materiale collegato a residenza alla rete, deve avere un dispositivo di sezionamento facile da raggiungere e che deve essere inserito all'esterno del apparecchio.
- Scollegare l'apparecchiatura dalla presa a muro se si prevede di non utilizzarla per qualche giorno.
- Per disconnettere i cavi, tirare facendo forza sul connettore.
- La prese d'alimentazione deve trovarsi a prossimità dell'apparecchiatura ed essere facilmente accessibile.
- Non far cadere il cavo di alimentazione né appoggiarci sopra degli oggetti pesanti.

Se uno dei cavi di alimentazione é danneggiato, spegnere immediatamente l'apparecchiatura. E' pericoloso far funzionare questa apparecchiatura con un cavo di alimentazione danneggiati, un cavo graffiato può provocare un rischio di incendio o uno shock elettrico. Verificare i cavi di alimentazione spesso. Contattare il vostro rivenditore o il servizio assistenza per una sostituzione.

• **CONNESSIONE:** Tutti gli ingressi e le uscite (ad eccezione per l'ingresso di alimentazione) sono sorgenti di energia in classe 1 (ES1) come definito nelle normative IEC/UL 62368-1. Limiti ES1: 60Vdc or 30V rms/ 42.4V di picco.

• **RIPARAZIONI E ASSISTENZA:** Scollegare tutti i cavi di alimentazione dalle prese prima di fare manutenzione. In accordo alle normative IEC 62368-1, una persona abilitata è autorizzata a effettuare le seguenti operazioni :

- Aprire il pannello frontale e effettuare la pulizia dei filtri (dipende dal modello)
- Sostituire un alimentatore rimovibile (dipende dal modello)

I fusibili presenti nel dispositivo non sono stati progettati per essere sostituibili.

L'utilizzatore non deve in nessun caso cercare di riparare l'apparecchiatura, poiché con l'apertura del coperchio metallico o di qualsiasi altro pezzo costituente la scatola metallica, nonché svitare le viti che appaiono esteriormente, poiché ciò può provocare all'utilizzatore un rischio di shock elettrico o altri rischi. La batteria al litio all'interno dell'apparato non e' sostituibile. In caso di problemi contattare il fornitore o Analog Way.

• **APERTURE DI VENTILAZIONE:** Le apparecchiature possono comportare delle aperture di ventilazione, si prega di non introdurre mai oggetti o ostruire le sue fessure. Se un liquido o un oggetto penetra all'interno

dell'apparecchiatura, disconnetterla e farla controllare da personale qualificato prima di rimetterla in servizio.

2.1.4. German

Um den Betrieb dieses Geräts zu verstehen, raten wir Ihnen vor der Inbetriebnahme alle Sicherheits- und Betriebsanweisungen genau zu lesen. Diese Sicherheits- und Betriebsanweisungen für einen späteren Gebrauch sicher aufbewahren. Alle in den Unterlagen, an dem Gerät und hier angegebenen Sicherheitsanweisungen einhalten.

- **ACHTUNG:** Nicht für Kinder geeignet. Um jegliches Risiko eines Stromschlags oder Feuers zu vermeiden, das Gerät nicht Regen, Feuchtigkeit oder intensiven Wärmequellen aussetzen. Dieses Gerät ist nicht geeignet, um in der Nähe von Kindern betrieben zu werden. Lassen Sie Kinder in der Nähe des Geräts nicht unbeaufsichtigt.
- **EINBAU:** Eine ausreichende Luftzufuhr sicherstellen, um jegliche Überhitzung im Gerät zu vermeiden. Das Gerät nicht auf und in Nähe von Textiloberflächen, die Belüftungsöffnungen verschließen können, aufstellen. Das Gerät nicht in Nähe von Wärmequellen, wie z.B. Heizkörper oder Warmluftkappe, aufstellen und es nicht dem direkten Sonnenlicht, übermäßigem Staub, Vibrationen oder mechanischen Stößen aussetzen. Dies kann zu Betriebsstörungen und Unfällen führen.
- **STROMVERSORGUNG:** Das Gerät nur mit der auf dem Gerät bezeichnete Stromquelle betreiben. Gerät mit geerdeter Hauptstromversorgung muss an eine Stromquelle mit effizienter Erdung angeschlossen werden. Diese Erdung darf auf keinen Fall geändert, umgangen oder entfernt werden. Anschluss von Geräten ans Stromnetz muss nach Abzweigschalter des Gebäudes Installation.



Für Geräte, die mit den obigen Symbolen gekennzeichnet sind, darf nur eine unterwiesene Person das Gerät mit dem Stromnetz verbinden oder vom Stromnetz trennen. Zuerst das Gerät erden bevor die Spannungsversorgung hergestellt wird. Verwenden Sie Erdungskabel und eine Schraube auf der Rückseite des Gehäuses, um das Gerät zu erden.

NETZKABEL: Das Gerät ist mit ein oder mehrere lösbaren Netzkabel ausgestattet.



Ein mit dem obigen Symbol gekennzeichnetes Gerät weist darauf hin, dass das Gerät über mehrere Netzkabel verfügt. Um das Gerät vom Stromnetz zu trennen, muss eine unterwiesene Person alle Netzkabel am Geräteeingang abziehen.

Achtung

Die Netzkabel stellt die einzige Möglichkeit dar, das Gerät vollständig vom Netzanschluss zu trennen.

Bei Geräten mit mehreren Netzkabeln: Um das Gerät vom Stromnetz zu trennen, muss jedes Netzkabel am Geräteeingang abgezogen werden. Es ist nicht erlaubt, sie an einen Zwischenstecker oder Mehrfachsteckdose zwischen dem Produkt und der Steckdose in der Wand anzuschließen, die dazu verwendet werden könnten, mehrere Stromversorgungen zu trennen, was den Zugang zu stromführenden Teilen an der Stelle ermöglichen würde, an der die Stromversorgung unterbrochen wurde.

Bitte beachten Sie die folgenden Hinweise:

- Wenn Geräte dauerhaft am Netz bleiben, müssen sie über eine leicht zugängliche Trennvorrichtung verfügen, die außen am Gerät angebracht sein muss.
- Trennen Sie das Gerät vom Stromnetz, wenn es einige Tage oder länger nicht benutzt wird.
- Die Kabel mittels des Steckers herausziehen. Niemals am Stromkabel selbst ziehen.
- Die Steckdose muss sich in der Nähe des Geräts befinden und leicht zugänglich sein.
- Das Stromkabel nicht fallen lassen und keine schweren Gegenstände darauf stellen.

Wenn eines der Netzkabel beschädigt ist, das Gerät sofort abschalten. Es ist gefährlich das Gerät mit einem beschädigten Stromkabel zu betreiben; ein abgenutztes Kabel kann zu einem Feuer oder Stromschlag führen. Die Stromkabel regelmäßig untersuchen. Für Ersatz wenden Sie sich an Ihren Verkäufer oder eine Kundendienststelle.

- **ANSCHLÜSSE:** Alle Eingänge und Ausgänge (ausgenommen der Stromversorgung) entsprechen der der ES1 Klassifizierung entsprechend der IEC/UL 62368-1. ES1 max. Auslegung: 60Vdc oder 20V rms / 42,4V Spitze.
- **REPARATUR UND WARTUNG:** Trennen sie alle Netzkabel vom Strom, bevor Sie eine Wartung oder andere Arbeiten am Gerät durchführen.

Gemäß der IEC 62368-1 Norm ist ein gewöhnlicher Nutzer autorisiert, einer unterwiesenen Person ist es erlaubt:

- die Gehäusefront zu öffnen und den Luftfilter zu reinigen (je nach Modell)
- Austauschen der herausnehmbaren Netzteile (hängt vom Modell ab)

Die im Gerät vorhandene(n) Sicherung(en) ist/sind nicht dafür ausgelegt, austauschbar zu sein.

Der Benutzer darf keinesfalls versuchen das Gerät selbst zu reparieren, die Öffnung des Geräts durch Abnahme der Abdeckhaube oder jeglichen anderen Teils des Gehäuses sowie die Entfernung von außen sichtbaren Schrauben zu Stromschlägen oder anderen Gefahren für den Benutzer führen kann. Die im Gerät eingebaute Lithium Batterie ist nicht austauschbar. Im Falle eines Problems nehmen Sie Kontakt mit Ihrem Lieferanten auf oder auf Analog Way.

- **ÖFFNUNGEN UND MUNDUNGEN:** Die Geräte können über Öffnungen verfügen (Belüftung, Schlitze, usw.). Niemals Gegenstände in die Öffnungen einführen oder die Öffnungen verschließen. Wenn eine Flüssigkeit oder ein Gegenstand in das Gerät gelangt, den Stecker herausziehen und es vor einer neuen Inbetriebnahme von qualifiziertem Fachpersonal überprüfen lassen.

2.1.5. Spanish

Para comprender mejor el funcionamiento de este aparato, le recomendamos que le acudadosamente todas las consignas de seguridad y de funcionamiento del aparato antes de usarlo. Conserve las instrucciones de seguridad y de funcionamiento para que pueda consultarlas posteriormente. Respete todas las consignas indicadas en la documentación, relacionadas con el producto y este documento.

- **CAUIDADO:** No recomendado para niños. Para prevenir cualquier riesgo de choque eléctrico y de incendio, no exponga este aparato a la lluvia, a la humedad ni a fuentes de calor intensas. Este equipo no es adecuado para su utilización en lugares donde haya niños.
- **INSTALACIÓN:** Cerciórese de que haya una circulación de aire suficiente para evitar cualquier sobrecalentamiento al interior del aparato. No coloque el aparato cerca ni sobre una superficie textil que

podiera obstruir los orificios de ventilación. No instale el aparato cerca de fuentes de calor como radiador o boca de aire caliente, ni en un lugar expuesto a los rayos solares directos o al polvo excesivo, a las vibraciones o a los choques mecánicos. Esto podría provocar su mal funcionamiento o un accidente.

• **ALIMENTACIÓN:** Ponga a funcionar el aparato únicamente con la fuente de alimentación que se indica en el aparato. Los aparatos deben estar conectados obligatoriamente a una fuente equipada con una puesta a tierra eficaz. Por ningún motivo este enlace de tierra deberá ser modificado, cambiado o suprimido. Conexión del equipo a la red eléctrica debe ser posterior del interruptor de circuitos derivados de la instalación del edificio.



Para equipos identificados con los símbolos anteriores, sólo una persona calificada está autorizada a conectar o desconectar el equipo. Conecte la toma de tierra antes de conectar el equipo al suministro eléctrico. Utilice un cable para conecta cualquier tornillo del chasis, con la toma de tierra de la instalación.

• **CABLE DE ALIMENTACION:** El equipo se suministra con uno o más cables de alimentación.



Un dispositivo identificado con el símbolo anterior indica que el equipo tiene más de un cable de alimentación. El apagado debe ser realizado por una persona cualificada desconectando todos los cables del dispositivo.

Atención

Los cables de alimentación constituyen el único medio de desconectar el aparato totalmente de la red eléctrica.

For equipment equipped with multiple power cords: To remove power from product, always disconnect each power cord at appliance inlet. It is not allowed to connect them to intermediate terminal between product and plug in the wall that could be used to disconnect several power supplies giving access to live parts at a point where mains was disconnected.

Para unidades con más de un cable de alimentación: para desconectar el equipo, siempre desconecte cada cable del conector de alimentación. No utilice una regleta para conectar cables entre el equipo y un enchufe, ya que desconectar varias fuentes de alimentación al mismo tiempo puede hacer accesible una tensión peligrosa en el conector que se ha desconectado del enchufe mismo.

Aplicar las siguientes consignas:

- El material conectado a residencia a la red informática, debe de tener un dispositivo de seccionamiento fácilmente accesible que debe de ser incorporado al exterior del aparato.
- Desconectar el aparato del enchufe mural si no piensa utilizarlo durante varios días.
- Para desconectar los cables, tire de la clavija. No tire nunca de los cables propiamente dichos.
- El enchufes de alimentación debe estar cerca del aparato y ser de fácil acceso.
- No deje caer el cable de alimentación ni coloque objetos pesados encima de ellos.

Si uno de cables de alimentación sufriera algún daño, ponga el aparato inmediatamente fuera de tensión. Es peligroso hacer funcionar este aparato con un cable averiado, ya que un cable dañado puede provocar un incendio o un choque eléctrico. Verifique el estado los cables de alimentación de vez en cuando. Póngase en contacto con su distribuidor o con el servicio de posventa si necesita cambiarlo.

- **CONEXIONES:** Todas las entradas y salidas (excepto la entrada de corriente) son de nivel eléctrico clase 1 (ES1) tal como se define en la norma IEC / UL 62368-1. Límites de ES1 60 VCC ó 30 V rms / 42,4 V de pico.
- **REPARACIÓN Y MANTENIMIENTO:** Desconecte todos los cables de alimentación de la red eléctrica antes de realizar el mantenimiento.

De acuerdo con la norma IEC 62368-1, solo una persona cualificada está autorizada a realizar esta operación:

- Abrir la parte frontal del aparato y limpiar el filtro del aire (depende del modelo)
- Cambiar la fuente de alimentación extraíble (depende del modelo)

Los fusibles presentes en el dispositivo no han sido diseñados para ser reemplazables.

Por ningún motivo, el usuario deberá tratar de efectuar operaciones de reparación, ya que si abre los aparatos retirando el capó o cualquier otra pieza que forma parte de las cajas o si destornilla los tornillos aparentes exteriores, existe el riesgo de producirse una explosión, choques eléctricos o cualquier otro incidente. La batería interna de litio no es reemplazable. En caso de problema, contacte con su proveedor o Analog Way.

- **ABERTURAS Y ORIFICIOS:** Los aparatos pueden contener aberturas (aireación, ranuras, etc.). No introduzca allí ningún objeto ni obstruya nunca estas aberturas. Si un líquido o un objeto penetra al interior del aparato, desconéctelo y hágalo revisar por personal cualificado antes de ponerlo nuevamente en servicio.

2.1.6. Finnish

Kaikki turvallisuus- ja käyttöohjeet on luettava ennen tuotteen käyttöä, ja ne on säilytettävä lisätarvetta varten. Noudata kaikkia tämän tuotteen varoituksia ja sen käyttöohjeita.

- **VAROITUS:** Ei sovellu lapsille. Sähköiskun ja tulipalon vaaran estämiseksi älä altista tätä laitetta sateelle, kosteudelle tai voimakkaille lämmönlähteille (kuten lämmittimille ja suoralle auringonvalolle). Tämä laite ei sovellu käytettäväksi paikoissa, joissa on todennäköisesti lapsia.
- **ASENNUS:** Laitteen kotelon aukot on suunniteltu ilmanvaihtoa varten ja ylikuumenemisen välttämiseksi. Varmista, että ilmavirta aukoista ei ole estynyt. Varmista, että laitetta ei koskaan sijoiteta lähelle tekstiilipintaa, joka voi tukkia aukot. Pidä myös poissa liiallisesta pölystä, tärinästä ja iskuista.
- **VIRRANSYÖTTÖ:** Käytä vain virtalähteen ilmoittamaa virransyöttöä. Maadoituspistokkeella varustettuja laitteita tulee käyttää vain maadoitustyyppisen pistorasian kanssa. Tätä maadoitusta ei saa millään tavalla muuttaa, välttää tai tukahduttaa. Laitteiden kytkemisen pääsytöön on tapahduttava rakennuksen sulakkeen jälkeen.



Yllä olevilla symboleilla tunnistetuissa laitteissa vain opastettu henkilö saa kytkeä ja irrottaa verkkojohdon laitteesta. Maadoitus on pakollinen ennen pistokeliitäntää.

Liitä maadoituskaapelilla yksikön rungon ruuvi maahan.

- **VIRTAJOHTO:** Laitteen mukana toimitetaan yksi tai useampi irrotettava virtajohto.



Yllä olevalla symbolilla tunnistettu laite osoittaa, että laitteessa on useita virtajohtoja. Verkkovirran irrottamiseksi opastetun henkilön on irrotettava kaikki virtajohdot laitteen virtalähteestä.

Varoitus

Virtajohdot ovat ainoa tapa irrottaa laite kokonaan päävirrasta.

Laitteet, joissa on useita virtajohtoja: Jos haluat katkaista virran tuotteesta, irrota aina jokainen virtajohto laitteesta. Virtajohtoja ei saa kytkeä tuotteen ja seinässä olevan pistokkeen väliseen väliliittimeen, jota voidaan käyttää useiden virtalähteiden irrottamiseen, jotka antavat pääsyn jännitteisiin osiin kohdassa, jossa verkkovirta on irrotettu.

Käytä seuraavia ohjeita:

- Verkkoon liitetyissä laitteissa on oltava irroitusjärjestelmä, johon pääsee helposti käsiksi ja joka sijaitsee yksikön ulkopuolella.
- Irrota virta verkkovirrasta, jos laite on poissa käytöstä useamman päivän.
- Irrota virtajohdot; Älä vedä virtajohdoista, vaan aina pistokkeesta.
- Pistorasian tulee aina olla laitteen lähellä ja helposti saatavilla.
- Virtajohdot on reititettävä siten, että niiden päälle tai niitä vasten asetetut esineet eivät purista niitä.

Jos jokin virtajohdoista on vaurioitunut, irrota laite pistorasiasta. Laitteen käyttäminen vaurioituneen virtajohdon kanssa voi altistaa laitteen sähköiskuille tai muille vaaroille. Tarkista virtajohtojen kunto säännöllisesti. Ota yhteyttä jälleenmyyjään tai huoltokeskukseen saadaksesi vaihdon, jos virtajohto on vaurioitunut.

- **LIITÄNNÄT:** Kaikki tulot ja lähdöt (paitsi tehonsyöttö) kuuluvat IEC/UL 62368-1:ssä määriteltyyn sähköenergiälähdeluokkaan 1 (ES1).

ES1-rajat: 60Vdc tai 30V rms / 42.4V huippu.

- **HUOLTO:** Irrota kaikki virtajohdot pistorasiasta ennen huoltoa.

IEC 62368-1 -standardin mukaan opastetulla henkilöllä on valtuudet:

- Avaa etupaneelin kaappi ja puhdistaa ilmansuodatin (mallista riippuen)
- Vaihda irrotettava virtalähde (mallista riippuen)

Laitteessa olevia sulakkeita ei ole suunniteltu vaihdettaviksi.

Älä yritä huoltaa tätä tuotetta itse avaamalla tai irrottamalla suojuksia ja ruuveja, koska se voi altistaa laitteen sähköiskuille tai muille vaaroille. Sisäistä litiumkennoakkua ei voi vaihtaa. Jos sinulla on ongelmia, ota yhteyttä tavaran toimittajaan tai Analog Way tuotetukeen.

- **AUKOT:** Älä koskaan työnnä minkäänlaisia esineitä tähän tuotteeseen aukkojen läpi. Jos nesteitä on roiskunut tai esineitä on pudonnut laitteeseen, irrota se välittömästi pistorasiasta ja anna pätevän teknikon tarkastaa se.

2.1.7. Swedish

Alla säkerhets- och driftsinstruktioner bör läsas innan produkten används och bör underhållas för vidare referens. Följ alla varningar på denna produkt och dess bruksanvisning.

- **WARNING:** Ej lämplig för barn. För att förhindra risken för elektriska stötar och brand, utsätt inte enheten för regn, fukt eller intensiva värmekällor (som värmare och direkt solljus). Denna utrustning är inte lämplig för användning på platser där barn sannolikt kommer att vara närvarande.
- **INSTALLATION:** Slitsar och öppningar i enheten är avsedda för ventilation och för att undvika överhettning. Se till att enheten aldrig placeras nära en textilyta som kan blockera öppningarna. Håll dig också borta från mycket damm, vibrationer och stötar.
- **POWER:** Använd endast den strömförsörjning som anges på enheten för strömkällan. Enheter utrustade med en jordad kontakt bör endast användas med ett jordat uttag. Denna jordning får inte på något sätt modifieras, undvikas eller undertryckas. Anslutning av utrustning till huvudförsörjningen måste ske efter grenbrytare i byggnadsinstallationen.



För utrustning som identifieras med symbolerna ovan får endast en instruerad person ansluta och koppla bort nätkabeln från enheten. Jordning är obligatorisk innan stickpropp ansluts.

Använd en jordkabel för att ansluta en skruv på enhetens chassi till jord.

- **STRÖMKABEL:** Enheten är utrustad med en eller flera löstagbara nätsladdar.



En enhet som identifieras med symbolen ovan indikerar att utrustningen har flera nätsladdar. För att ta bort strömmen ska en instruerad person koppla bort alla nätsladdar vid apparatens strömintag.

Försiktighet

Nätsladdarna utgör det enda sättet att helt koppla bort utrustningen från huvudströmmen.

För utrustning utrustad med flera nätsladdar: För att ta bort strömmen från produkten, koppla alltid ur varje nätsladd vid apparatens inlopp. Det är inte tillåtet att ansluta dem till en mellanterminal mellan produkten och kontakten i väggen, som kan användas för att koppla bort flera nätaggregat som ger tillgång till spänningsförande delar vid en punkt där elnätet var frånkopplat.

Använd följande riktlinjer:

- Utrustningen som är ansluten till nätverket måste ha ett frigöringssystem som är lättillgängligt och placerat utanför enheten.
- Koppla bort strömmen från elnätet om enheten inte används på några dagar eller mer.
- För att dra ur nätsladdarna; Dra inte i nätsladdarna utan alltid i själva kontakten.
- Uttaget ska alltid vara nära enheten och lättillgängligt.
- Nätsladdar ska dras så att de inte kan trampas på eller klämmas av föremål som placeras på eller mot dem.

Om en av nätsladdarna är skadad, koppla ur enheten. Om du använder enheten med en skadad nätsladd kan enheten utsättas för elektriska stötar eller andra faror. Kontrollera skicket på nätsladdarna med jämna mellanrum. Kontakta din återförsäljare eller servicecenter för utbyte om den är skadad.

- **ANSLUTNINGAR:** Alla in- och utgångar (förutom strömingången) är elektrisk energikälla klass 1 (ES1) enligt definitionen i IEC/UL 62368-1.

ES1-gränser: 60Vdc eller 30V rms/ 42.4V topp.

- **SERVICE:** Koppla bort alla nätkablar från elnätet före service.

Enligt IEC 62368-1-standarden är en instruerad person behörig att:

- Öppna skåpet på frontpanelen och rengör luftfiltret (beroende på modell)

- Byt en löstagbar strömkälla (beroende på modell)

Säkring/säkringarna som finns i enheten har inte utformats för att vara utbytbara.

Försök inte serva denna produkt själv genom att öppna eller ta bort lock och skruvar eftersom det kan utsätta din enhet för elektriska stötar eller andra faror. Det interna litiumcells batteriet är inte utbart. Vid problem, kontakta din leverantör eller Analog Way.

- **ÖPPNINGAR:** Skjut aldrig in föremål av något slag i denna produkt genom öppningarna. Om vätskor har spillts eller föremål har fallit in i enheten, koppla ur den omedelbart och låt en kvalificerad tekniker kontrollera den.

2.1.8. Norwegian

Alle sikkerhets- og bruksanvisninger bør leses før produktet tas i bruk og bør vedlikeholdes for videre referanse. Vennligst følg alle advarslene på dette produktet og bruksanvisningen.

- **ADVASEL:** Ikke egnet for barn. For å unngå fare for elektrisk støt og brann, må du ikke utsette denne enheten for regn, fuktighet eller intense varmekilder (som varmeovner og direkte sollys). Dette utstyret er ikke egnet for bruk på steder der det er sannsynlig at barn er til stede.

- **INSTALLASJON:** Spor og åpninger i enheten er gitt for ventilasjon og for å unngå overoppheting. Pass på at enheten aldri plasseres i nærheten av en tekstiloverflate som kan blokkere åpningene. Hold deg også unna mye støv, vibrasjoner og støt.

- **STRØM:** Bruk kun strømforsyningen som er angitt på enheten til strømkilden. Enheter utstyrt med jordingsplugg skal kun brukes med en jordet stikkontakt. Denne jordingen skal på ingen måte endres, unngås. Tilkobling av utstyr til hovedforsyning må skje etter grenbryteren til bygningsinstallasjonen.



For utstyr identifisert med symbolene ovenfor, er det kun en instruert person som har lov til å koble til og fra strømkabelen fra enheten. Jording er obligatorisk før pluggtilkobling.

Bruk en jordingskabel for å koble en skrue på enhetens chassis til jord.

- **STRØMLEDNING:** Enheten er utstyrt med en eller flere uttrekkbare strømledninger.



En enhet identifisert med symbolet ovenfor indikerer at utstyret har flere strømledninger. For å fjerne strømmettet, skal en instruert person koble fra alle strømledninger ved apparatets strøminntak.

 **Forsiktig**

Strømledningene utgjør den eneste måten å koble utstyret helt fra hovedstrømmen.

For utstyr utstyrt med flere strømledninger: For å fjerne strømmen fra produktet, koble alltid fra hver strømledning ved apparatets inntak. Det er ikke tillatt å koble dem til mellomterminalen mellom produktet og pluggen i vegg, som kan brukes til å koble fra flere strømforsyninger som gir tilgang til strømførende deler på et punkt der strømmettet var frakoblet.

Bruk følgende retningslinjer:

- Utstyret som er koblet til nettverket må ha et utlørsystem som er lett tilgjengelig og plassert utenfor enheten.
- Koble strømmen fra strømmettet hvis enheten ikke brukes på noen dager eller mer.
- For å koble fra strømledningene; Ikke trekk i strømledningene, men alltid i selve støpselet.
- Stikkontakten skal alltid være i nærheten av enheten og lett tilgjengelig.
- Strømledninger bør legges slik at de ikke kan bli tråkket på eller klemt av gjenstander plassert på eller mot dem.

Hvis en av strømledningene er skadet, kobler du fra enheten. Bruk av enheten med en skadet strømledning kan utsette enheten for elektrisk støt eller andre farer. Kontroller tilstanden til strømledningene med jevne mellomrom. Kontakt din forhandler eller servicesenter for utskifting hvis den er skadet.

• **TILKOBLINGER:** Alle innganger og utganger (unntatt strøminngangen) er elektrisk energikilde klasse 1 (ES1) som definert i IEC/UL 62368-1.

ES1-grenser: 60Vdc eller 30V rms / 42.4V topp.

• **SERVICE:** Koble alle strømledninger fra strømmettet før service.

I henhold til IEC 62368-1-standarden er en instruert person autorisert til å:

- Åpne frontpanelskapet og rengjør luftfilteret (avhengig av modell)
- Bytt en avtakbar strømforsyning (avhengig av modell)

Sikringen(e) i enheten er ikke designet for å kunne byttes ut.

Ikke forsøk å utføre service på dette produktet selv ved å åpne eller fjerne deksler og skruer, siden det kan utsette enheten for elektrisk støt eller andre farer. Det interne litiumcellebatteriet kan ikke byttes ut. Hvis det oppstår et problem, kontakt din leverandør eller Analog Way.

• **ÅPNINGER:** Skyv aldri gjenstander av noe slag inn i dette produktet gjennom åpningene. Hvis det har blitt sølt væske eller gjenstander har falt inn i enheten, må du umiddelbart koble den fra og få den kontrollert av en kvalifisert tekniker.

2.1.9. Symbols on product identification and warning labels



ATTENZIONE
 RISCHIO DI SCOSSE ELETTRICHE DOVUTE ALL'ENERGIA IMMAGAZZINATA NEI CONDENSATORI. ATTENDERE 2 MINUTI DOPO LA DISCONNESSIONE DELLE SPINE.
 ATTENZIONE: ALTA CORRENTE DI CONTATTO. COLLEGARE LA TERRA PRIMA DI COLLEGARLA ALL'ALIMENTAZIONE.

CUIDADO
 RIESGO DE DESCARGA ELÉCTRICA POR CORRIENTE ALMACENADA EN LOS CONDENSADORES. ESPERE 2 MINUTOS DESPUES DE HABER DESCONECTADO EL EQUIPO DE LA CORRIENTE ELÉCTRICA.
 CUIDADO: POSIBLE CORRIENTE POR DERIBACIÓN. CONECTE LA TOMA DE TIERRA ANTES DE CONECTAR EL EQUIPO AL SUMINISTRO ELÉCTRICO.

VAROITUS
 SÄHKÖISKUN VAARA KONDENSAATTORIIN VARASTOIDUSTA ENERGIASTA. ODOTA 2 MINUUTTIA PISTOKKEIDEN IRROTTAMISEN JÄLKEEN.
 VAROITUS: LIITÄ MAADOITUS ENNEN LIITTÄMISTÄ VIRTALÄHTEESEEN.

VARNING
 RISK FÖR ELEKTRISKA STÖTAR PÅ GRUND AV ENERGI SOM LAGRAS I KONDENSATORER. VÄNTA I 2 MINUTER EFTER ATT PLUGGARNÄR KOPPLATS BORT.
 FÖRSIKTIGHET: ANSLUT JORD INNAN DU ANSLUTER TILL MATNINGEN

ADVARSEL
 FARE FOR ELEKTRISK STØT FRA ENERGI LAGRET I KONDENSATORER. VENT I 2 MINUTTER ETTER AT PLUGGENE ER KOBLET FRA.
 FØRSIKTIGHET: KOBLE TIL JORD FØR DU KOBLER TIL STRØMFORSYNINGEN.

CAUTION ATTENTION
 ELECTRICAL SHOCK HAZARD. DISCONNECT ALL POWER SOURCES TO REMOVE POWER FROM EQUIPMENT
 RISQUE DE CHOC ÉLECTRIQUE. DEBRANCHER TOUS LES CORDONS POUR COUPER L'ALIMENTATION

VORSICHT
 GEFAHR DURCH ELEKTRISCHEN SCHLAG. TRENNEN SIE ALLE NETZKABEL, UM DIE SPANNUNGSVERSORGUNG VOLLSTÄNDIG ZU UNTERBRECHEN.

ATTENZIONE
 RISCHIO DI SCOSSE ELETTRICHE. SCOLLEGARE TUTTE LE FONTI DI ALIMENTAZIONE PER RIMUOVERE L'ALIMENTAZIONE DALL'APPARECCHIATURA.

CUIDADO
 PELIGRO DE DESCARGA ELÉCTRICA: DESCONNECTE TODOS LOS CABLES DE ALIMENTACIÓN DE LOS EQUIPOS, PARA EVITAR POSIBLES DESCARGAS ELÉCTRICAS.

VAROITUS
 SÄHKÖISKUN VAARA. IRROTA KAIKKI VIRTALÄHTEET VIRRRAN POISTAMISEKSI LAITTEESTA.

FØRSIKTIGHET
 FARE FOR ELEKTRISK STØT. KOBLE FRA ALLE STRØMKILDER FOR Å FJERNE STRØMMEN FRA UTSTYRET.

FØRSIKTIGHET
 RISK FÖR ELEKTRISKA STÖTAR. KOPPLA BORT ALLA STRÖMKÄLLOR FÖR ATT TA BORT STRÖMMEN FRÅN UTRUSTNINGEN.

 Caution, risk of electric shock

All power sources shall be disconnected before servicing to avoid shock hazard.

 Caution, risk of electric shock

The protective conductor (PE) should be connected first to main protective earthing terminal before connecting the line and neutral.

 Protective earth

Connect an earth terminal to the ground.

 Disconnection, all power plugs

All power sources shall be disconnected before servicing to avoid shock hazard.

 Alternating current

The equipment is suitable for alternating current only.



Caution

The current situation needs operator awareness or operator action in order to avoid undesirable consequences.



Caution, moving fan blades

Keep away from moving fan blades.

Waste Electrical and Electronic Equipment (WEEE) Directive



In the European Union, this label indicates that this product should not be disposed of with household waste. It should be deposited at an appropriate facility to enable recovery and recycling.

Directive sur la mise au rebut des appareils électriques et électroniques (Waste Electrical and Electronic Equipment - WEEE)



Dans l'Union européenne, cette étiquette indique que ce produit ne doit pas être jeté avec les déchets ménagers. Il doit être déposé à un site de récupération et de recyclage.

Richtlinie über Elektro- und Elektronik-Altgeräte (WEEE)



In der Europäischen Union wird mit diesem Etikett darauf hingewiesen, dass dieses Produkt nicht mit dem Hausmüll entsorgt werden darf. Es muss bei einer entsprechenden Einrichtung zum Recycling abgegeben werden.

Direttiva Rifiuti di apparecchiature elettriche ed elettroniche (RAEE)



Nell'Unione Europea, questa etichetta indica che il presente prodotto non deve essere smaltito insieme ai rifiuti domestici. Deve essere depositato in un impianto adeguato per consentirne il recupero e il riciclaggio.

Waste Electrical and Electronic Equipment Directive (Directiva sobre Residuos de aparatos eléctricos y electrónicos - WEEE)



En la Unión Europea, esta etiqueta indica que la eliminación de este producto no se puede hacer junto con el desecho doméstico. Debe depositarse en instalaciones adecuadas para permitir la recuperación y el reciclaje.

Sähkö- ja elektroniikkalaiteromudirektiivi (Waste Electrical and Electronic Equipment - WEEE)



Euroopan unionissa tämä merkintä osoittaa, että tätä tuotetta ei saa hävittää kotitalousjätteen mukana. Se tulee sijoittaa asianmukaiseen laitokseen hyödyntämistä ja kierrätystä varten.

Direktivet om avfall från elektrisk och elektronisk utrustning (Waste Electrical and Electronic Equipment - WEEE)



I Europeiska unionen indikerar denna etikett att denna produkt inte ska slängas med hushållsavfallet. Den bör deponeras på en lämplig anläggning för att möjliggöra återvinning och återanvändning.

Direktivet om avfall fra elektrisk og elektronisk utstyr (Waste Electrical and Electronic Equipment - WEEE)



I EU indikerer denne etiketten at dette produktet ikke skal kastes sammen med husholdningsavfallet. Den bør deponeres på et egnet anlegg for å muliggjøre gjenvinning og resirkulering.

2.1.10. Environmental specifications for all LivePremier models

RS alpha, RS1, RS2 and C:

- Dimensions without rack mount and handles: W 439.8 x H 177 x D 700 mm
- Dimensions with rack mount and handles: W 482.4 x H 177 x D 701 mm
- Product Weight: **RS alpha:** 23.8kg – **RS1:** 26.1kg – **RS2:** 28.2kg – **C:** 31.5kg
- Max consumption: **RS alpha:** 400W – **RS1:** 540W – **RS2:** 700W – **C:** 740W

RS3, RS4 and C+

- Dimensions without rack mount and handles: W 439.8 x H 221.2 x D 700 mm
- Dimensions with rack mount and handles: W 482.4 x H 221.2 x D 701 mm
- Product Weight: **RS3:** 35.3kg – **RS4:** 37.3kg – **C+ (fully loaded):** 38.9kg

- Max consumption: **RS3**: 850W – **RS4**: 1010W – **C+** (fully loaded): 1050W

RS5, RS6 and Cmax

- Dimensions without rack mount and handles: W 439.8 x H 264 x D 700 mm
- Dimensions with rack mount and handles: W 482.4 x H 264 x D 701 mm
- Product Weight: **RS5**: 42kg – **RS6**: 43.8kg – **Cmax** (fully loaded): 45kg
- Max consumption: **RS5**: 1050W – **RS6**: 1300W – **Cmax** (fully loaded): 1500W

General

- Cooling air flows from front side to rear
- Operating temperature: 0 to +40°C / +32°F to +104°F
- Storage temperature: -10 to +60°C / +14°F to +140°F
- Operating humidity: 10 to 80% (non-condensing)
- Input voltage range: 100-240 VAC autosensing, 50/60 Hz 12-5A

Safety standard

- IEC/EN/UL 62368-1
- CSA C22.2#62368-1

Electromagnetic compatibility

- EN55032
- EN55035
- EN61000
- FCC Part 15
- ICES

Environment

- RoHS
- WEEE

Caution

Should the unit lose power unexpectedly; unsaved settings may be lost.

2.1.11. UPS compatibility

LivePremier units are only compatible with online (or double conversion) Uninterruptible Power Supply systems (UPS) with no switching delay. Offline and Inline UPS are not supported.

2.2. Package Contents

The LivePremier sales package includes:

- One LivePremier unit
- Two or Three power cords depending on the LivePremier model
- One Rackmount kit
- One Ethernet cable
- One Quick start guide



For the latest versions of the User manual and Quick start guide

See www.analogway.com [http://www.analogway.com/].

2.3. Rack mount information

All LivePremier units are equipped with 4 handy anti-slip rubber feet and can be used directly on a table.



Anti-theft system

All units are equipped with a standard Kensington® security slot (7x3 mm).



For rack mount installation guide

See document *LivePremier – Rack mount* attached to this manual or check on www.analogway.com [http://www.analogway.com/].

3. Introducing LivePremier™

Good to know

LivePremier can process up to 160 Megapixels throughput at 10 bits 4:4:4 @60Hz without any limitation of pixel canvas size.

3.1. Modular architecture

LivePremier is designed to be modular. Input and Output cards can be configured to match source and display requirements.

The LivePremier product range includes seven fixed (preconfigured) models and three customizable models:

LivePremier family

Aquilon Models	4K60p inputs	4K60p outputs	Max 4K60p PGM outputs	Max 4K60p mixing layers*	Simultaneous 4K image channels	Rack units
RS alpha	8	4	4	4	12	4RU
RS1	16	8	4 + 4 Aux	4	12	4RU
RS2	16	12	8 + 4 Aux	8	12	4RU
RS3	24	12	8 + 4 Aux	8	24	5RU
RS4	24	16	12 + 4 Aux	12	24	5RU
RS5	32	16	12 + 4 Aux	12	24	6RU
RS6	32	20	16 + 4 Aux	16	24	6RU
C	0 to 16	0 to 16	8 + 8 Aux	up to 8	up to 12	4RU
C+	4 to 24	4 to 20	12 + 8 Aux	up to 12	up to 24	5RU
Cmax	4 to 32	4 to 24	16 + 8 Aux	up to 16	up to 24	6RU

*doubled for 2K/DL

Custom Unit

A fixed unit that has been modified becomes a Custom unit. For more information on input / output cards see  Input / Output cards ^[p.35].

Tip

Use Link to combine up to 4 devices of any type and size, multiplying the number of inputs and outputs but managing it as a single system. See  Appendix: LINK ^[p.193].

3.2. Supported formats and rates

LivePremier supports a wide range of formats and rates including custom formats which can be created directly in the user interface.

- Max horizontal timings: 8192 pixels
- Max vertical timings: 4096 lines
- Max frequency/rate: 144Hz for Inputs, Outputs and Internal rate.

More information on custom formats

See  Formats and EDID ^[p.125].

Note

Format with rates above 60Hz may not be supported by devices and accessories other than LivePremier devices (ex: DPH104, HDMI over fiber extenders, etc.).

3.3. Front panel

It is composed of one OLED display, two USB ports, three buttons (Power, Enter and Exit) and a coder. The front panel can be used for admin features or information (Firmware update, Network settings, Import/Export configuration, Factory Reset and Status check).

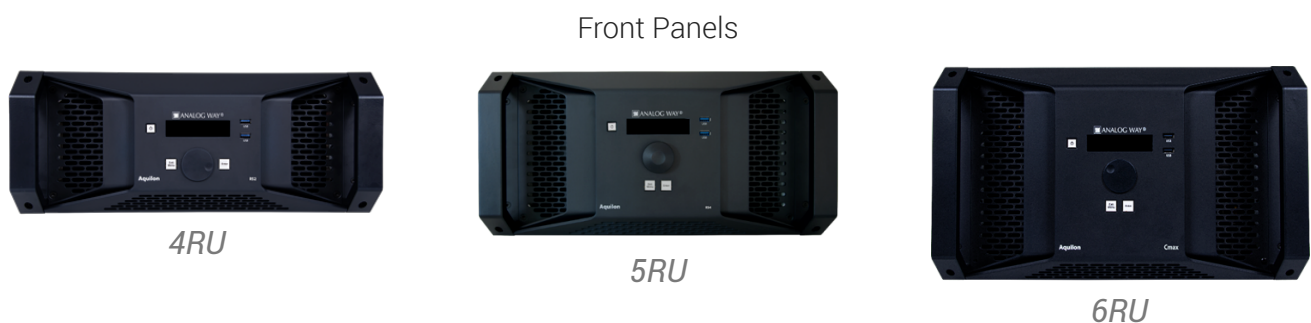

The front panel displays information such as device IP address, firmware version, or CPU and GPU status.

- Turn the coder to wake the display and select Status to show device information.
- Turn again to cycle through the following pages.

The display automatically goes off after 3 minutes of inactivity.

3.4. Rear panels

LivePremier rear panel (Aquilon Cmax):

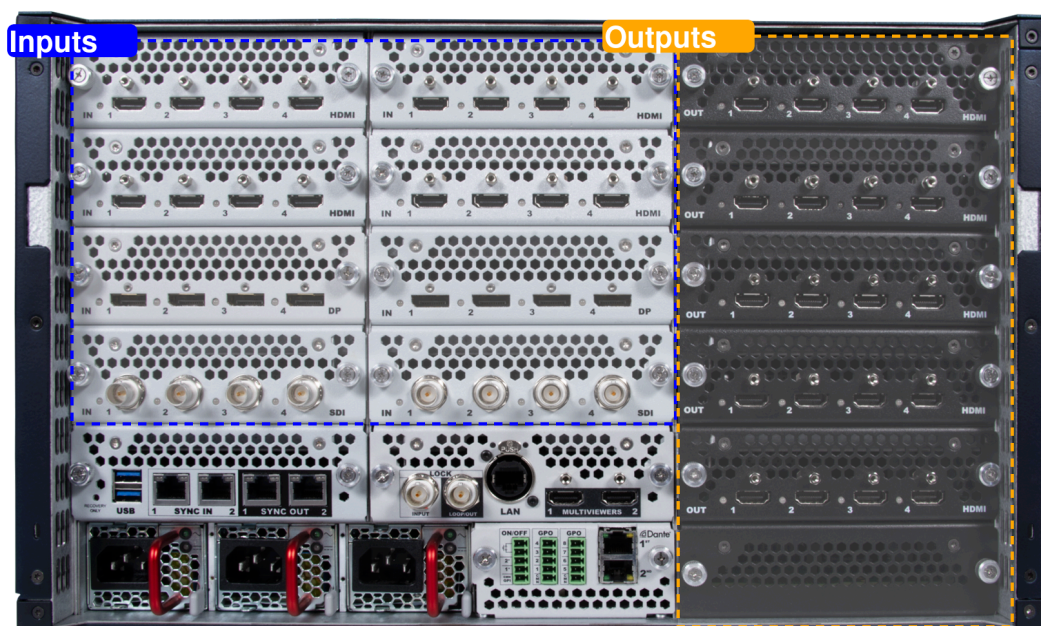

Virtual panel with Input / Output numbers (Aquilon RS4)

3.5. Input / Output cards

Input and output cards have different sizes and colors:

- silver for inputs
- black for outputs

They can be replaced on field, using dedicated slots (see [Rear panels](#)^[p.34]).

3.5.1. Available cards

- Standard input / output cards are composed of four identical connectors.
One connector represents one input / output, supporting formats: up to 4K@60Hz 4:4:4 or 2560x1600@144Hz
- IP/SDI card integrates two types of connectors allowing:
Up to four NDI streams on one RJ45 connector, supporting formats up to UHD@60Hz 4:2:2 with alpha channel or any (up to four) combination of NDI streams and 12G-SDI inputs (one per connector)
- 8-plug HDMI (requires Firmware version 4.0)
8 video signals in parallel, supporting formats: up to 4K@30Hz or up to 2560x1600@60Hz, with two deinterlacers (inputs 1 and 5); 4 audio channels per input
- Link Connector
Can interconnect up to 4 devices and manage them as a single unit, making possible to share up to 8 x 4K@60Hz inputs or 16 x DL@60Hz inputs between the units

LivePremier optional input and output cards

Option	Description
Four connectors cards	
Standard input and output cards	4 x DisplayPort 1.2
	4 x HDMI 2.0
	4 x HDMI 2.0 over optical fiber
	4 x 12G-SDI ¹
	4 x 12G-SFP non MSA ²
	4 x SDVoE (AV over IP)
Additional input cards	
IP/SDI	1 x 2.5GbE RJ45 ³ 4 x 12G-SDI
8-plug HDMI	8 x HDMI 1.4 ⁴
Others	
Link Connector	6 x 40G QSFP+modules ⁵
Filler	Filler input card or Filler output card

+ LivePremier optional input and output cards

¹ 12G-SDI is fully compatible with 3G-SDI and 6G-SDI

² 12G-SFP input and output cards can receive SFP modules either for SDI over Fiber or for SDI over IP / SMPTE

³ Compatible with 1GbE

⁴ Supports SDR input signals only (convertible internally to HDR10 or HLG)

⁵ Works with DAC cables

For more information, visit [our website \[https://www.analogway.com\]](https://www.analogway.com) or contact Analog Way support.

3.5.2. Change an input / output card

Installation rules

- Cards must be installed from top to bottom.

(Inputs and outputs are numbered in rows from left to right and from top to bottom (see  Rear Panel [p.34]).

- LivePremier units must have 2, 4 or 6 input cards (no odd numbers).
- Empty input / output card slots must be protected by Filler input / output cards to avoid long-term damage.



Tools required:

One cross-head screwdriver



Warning

- Do not remove cards other than input, output or control cards.
- Do not replace input cards with output cards and vice versa.
- Do not force cards elsewhere than their dedicated slots.

Prerequisite

The unit must be turned off and disconnected from power.

Input / output cards are NOT hot-swappable.

Procedure

1. Turn off the LivePremier unit and disconnect all power supply.
2. Locate the card to change.
3. Loosen the screws on both sides of the card, use the screwdriver if needed.
4. Carefully place the card in the provided slot.
5. Put the new card in place, keep a straight axis and pay attention to the rails.
6. Push the new card until mechanical stop to ensure the connection is correct.
7. Tighten the screws on both sides of the card, use the screwdriver.
8. Reconnect the power supplies and turn on the LivePremier unit.
9. Open the Web RCS to check the new card is correctly installed.
10. Update the LivePremier unit if needed.

Comments

- Link Connector card must be installed in the last output slot at the bottom of the chassis.
- Installing or replacing an 8-plug HDMI card requires changing the inputs numbering and rebooting the system.

3.6. Fixed parts

The following parts are fixed and available on all LivePremier units (except the second Power supply unit on 4RU units).

Warning

All parts other than input, output and control cards are fixed and should not be removed.



Fixed parts on all LivePremier units

3.6.1. Optional control card with DisplayPort Multiviewer outputs

Warning

- Changing the control card also changes the device configuration. If needed, export a configuration to recover it after the update (see [Save / Reset / Load Configuration](#) [p.54]).
- The control card is NOT hot swappable. The unit must be turned off and disconnected from power.
- Do not force cards in places other than slots specified in [LivePremier rear panel \(Aquilon Cmax\)](#) [p.34].

The control card with DisplayPort Multiviewer outputs is available as an option or an accessory. A LivePremier device can be equipped with two DisplayPort 1.2 Multiviewer outputs instead of the HDMI 2.0 plugs. These DisplayPort plugs support the DPH104 and can feed up to eight Full HD displays.

To change the control card, follow the same procedure as [Change an input / output card](#) [p.36].

More information about setting DPH104 on a Multiviewer output

See [Set a DPH104 for a Multiviewer DP output](#) [p.73].

3.6.2. USB and sync ports

All LivePremier units are equipped with four USB ports (two on the front panel, two on the rear panel). The sync ports can be used to synchronize LivePremier units with other devices.

Note

All sync ports are independent and can be used equally.

3.6.3. Framelock

A Framelock is used to synchronize the frame rate of multiple devices with a physical connection.

- The Framelock input is used to synchronize the LivePremier unit with an external reference.
- The Framelock loop out connector is then used to forward the sync signal to other devices.
- The Framelock loop out connector can also be used alone (as a sync signal generator for other devices).

3.6.4. GPIO

All LivePremier units are equipped with 3x MCO 5 pin connectors:

- 1x On/Off
- 2x GPI
- 8x GPO

More information on GPIO settings

See  GPIO ^[p.136].

3.6.5. Dante audio connectors

All LivePremier units are equipped with two dedicated Dante connectors to support up to 64 (8x8) audio input channels and 64 (8x8) audio output channels at 48 kHz.

Dante audio can only be controlled from the Dante ports used as primary & secondary connections.

The Dante network is a network dedicated to audio and separated from the LivePremier network.

More information on Audio settings

See  Audio ^[p.132].

3.6.6. Power supply units (PSU)

Recommendation

Use all powers supply units to optimize performance and redundancy.

LivePremier units are equipped with:

- 2 PSUs for 4RU units.
- 3 PSUs for 5RU units and 6RU units.

In nominal use there is power load balancing between the PSUs for optimized performance.

One PSU can fail without impacting performance (redundancy 1+1 or 2+1).

A 5RU and a 6RU LivePremier units cannot function with only one PSU working.

3.6.6.1. Power supply compatibility

Caution

- Use only power supplies provided or recommended by Analog Way.
- Ensure that all power supplies present on the unit are of the same type (type 1 or type 2). Contact technical support in case of a doubt.
- Do not use different types of power supplies in the same unit as it may damage the unit.

Because the LivePremier is modular, the power supplies can be removed and swapped between units.

However, the LivePremier product line uses two different models for the power supplies (type 1 and type 2).

Please note that they are not compatible with each other.

3.6.6.2. Power supply noise on standby

When a LivePremier unit is connected to power, some power supply fans will start running to cool down.

Please note that this noise is normal even if the unit is on standby.

3.6.6.3. Power supply noise on start up

When starting the LivePremier, some power supplies might be noisy depending on the reference. Please note that this noise is normal though it should not exceed 20 seconds. If needed, Power supplies status can be checked in the Web RCS.

More information

See  Power ^[p.50].

3.7. Accessories

For more information visit <https://www.analogway.com> or contact Analog Way support.

3.7.1. HDMI 2.0 over fiber extenders – Transmitter and Receiver



HDMI 2.0 over fiber extender

The extenders are designed to transfer HDMI 2.0 signal with embedded audio over one multimode fiber cable. One extender cable supports resolutions up to 4K@60Hz or custom formats such as 8192×1080@60Hz.

Max distance: 2500m / 8000ft. for Full HD - 600m / 500ft. for 4K@60Hz.

3.7.2. Rack-mountable power tray for optical extenders



Power tray for optical extenders (ex: Neutrik OpticalCON Duo)

There are three types of power trays with different connectors:

- 4x Neutrik opticalCON Duo + 8 slots for HDMI 2.0 over fiber extenders
- 4x Neutrik opticalCON Quad + 16 slots for HDMI 2.0 over fiber extenders
- 8x SC Duplex + 16 slots for HDMI 2.0 over fiber extenders

The power tray is a 1RU size housing accessory which can enclose up to 8 or 16 extenders, also providing power source for every installed device. The optical fibers are connected to the Neutrik opticalCON Duo, Neutrik opticalCON Quad, or SC Duplex connectors each carrying signal fibers from the extenders. The HDMI tail cables of the extenders are accessible directly at the back of the power tray.

3.8. Precautions when mounting a LivePremier unit

Warning

- For safety reasons, it is recommended to earth the unit. Use an earth cable (not provided) to earth a screw of the unit's chassis.
- Follow these precautions to avoid risks for products and users.

- Do not put a magnetic plate in contact with the upper part of the unit as it may block the fans of the unit.

When mounting the LivePremier unit, ensure proper air flow and consider the following points on safe use:

- Always use the handles built on the sides of the chassis for easy mounting into any standard rack or flight case.
- Remove the front and back panels of the flight case during operation to provide enough air flow through the unit and prevent overheating.
- Place the unit preferably in a cool and dry environment.
- The fans inside the unit draw in the air through the front panel and expel the heat through the rear panel. Therefore, it is crucial that both the front and the rear are always unobstructed. A minimum of 50 cm (20 in.) of clear space at the front and rear of the unit is recommended.
- Do not block the ventilation.
- Do not attach any stickers on the rear panel.
- Do not place any fluid above or near the unit.
- Do not place any magnetic equipment on or near the unit.
- Do not apply any pressure against the chassis or the connectors.

3.9. Powering on and off

3.9.1. Start the LivePremier unit

To safely start the LivePremier unit:

1. Connect all inputs and outputs.
2. Connect the power cables to the unit and then plug them into a mains socket.
3. Press the Power button on the front panel.

3.9.2. Power off the LivePremier unit

Tip

Saving the configuration before powering off is not necessary. The unit saves the current configuration in real time.

The following procedure is the recommended method to safely turn off the LivePremier unit:

- Press the Power button then press the Enter button to confirm.

3.9.3. Forced shutdown

Caution

Use forced shutdown only if the unit has crashed. Using forced shutdown regularly is not recommended.

If the LivePremier unit crashed, turn off the power by Forced shutdown:

- Press and hold the Power button on the front panel until shutdown.

3.10. Firmware update

It is possible to update the firmware from the front panel using a USB drive.

1. Load the updater file on a USB drive (root).

2. Connect the USB drive to the front panel.

The LivePremier unit automatically detects updater files on the USB drive.

If the updater file is not detected, go to **Control > Scan USB** device using the front panel buttons.

3. Select **OK** to continue.

4. The available updater files are displayed, select a file.

The updater files are extracted and verified.

5. Select **Update**.

After the installation, the LivePremier unit reboots.

6. If needed, import saved Configuration.

Recommendation

Perform a default reset after a firmware update.

4. Using the Web RCS

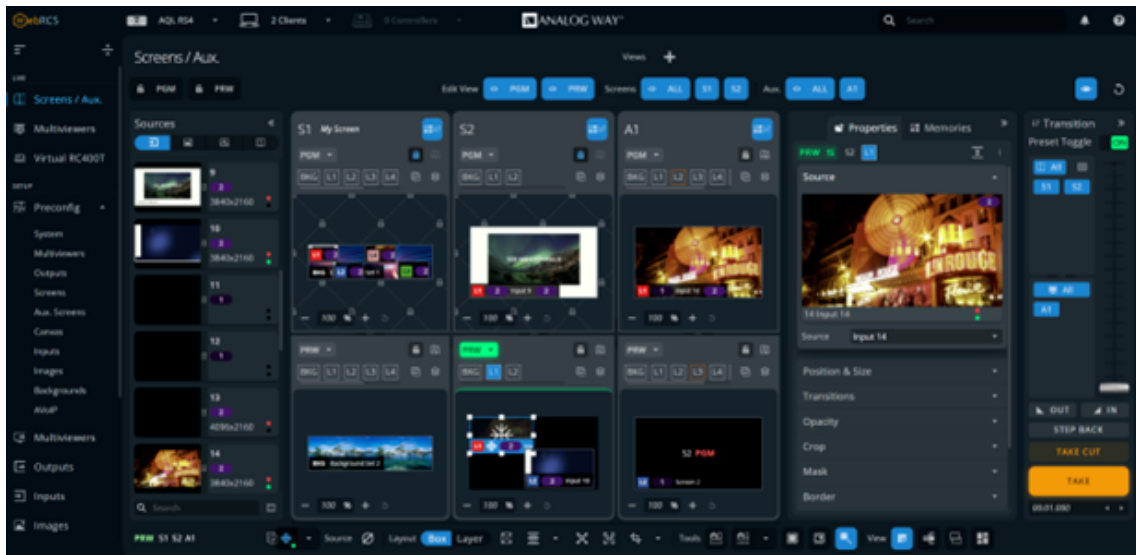

Web RCS Interface

The **Web RCS** is the main controller for the LivePremier. It is embedded in all units and compatible with all operating systems. LivePremier can be operated from any computer via wired network connection without installing any software.

The Web RCS supports both HTTP and HTTPS protocols.

Other controllers

- LivePremier units can also be controlled from their dedicated controller: the RC400T. For more information, see [Appendix: RC400T \[p.178\]](#).
- Control can also be integrated into automation and control systems, for more information, contact your local technical support.

4.1. Run the Web RCS

4.1.1. Web RCS requirements

- 1Gb Ram
- 200Mb of free space
- 100Mb Network adaptor or above
- 1920x1080 is the minimum and optimized screen resolution

Web browser

- Chrome (Recommended)
- Firefox
- Edge

- Opera
- Safari

Recommendation

Use the latest version of the web browser and keep it up to date.

In FHD screens, adjust the view using a zoom feature of the explorer to avoid interface overlaps.

The **Web RCS** is based on HTML5 and does not require Flash. It is optimized for Chrome web browser in full screen mode.

4.1.2. Default network settings

Tip

All connections should be done before starting the LivePremier unit.

Default network settings

IP Address: 192.168.2.140

Subnet Mask: 255.255.255.0

Port: 80

Ports to open

Make sure that ports 80, 443, 10591, 10606, 10691, 10692 and 10693 are available on your network and/or not blocked by firewall.

To connect to this address, a computer needs to be configured to use a unique IP address on the same network. If this setup is part of a larger network with other devices, please check with your network administrator before plugging these devices into the network to avoid any IP address conflicts.

Example of static IP address on one computer

Computer IP address: 192.168.2.50

Computer Subnet Mask: 255.255.255.0

4.1.3. Connection

To access the **Web RCS**, launch a web browser and enter the LivePremier IP address in the address bar. It is possible to connect up to 5 computers to the same LivePremier unit for real-time collaboration.

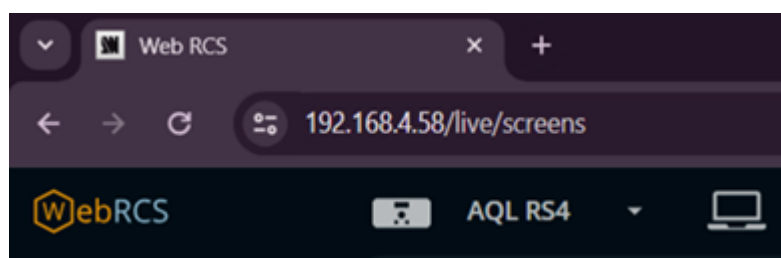

Web RCS connection

 **Default IP address of all devices**

192.168.2.140

 **Tip**

Computers using energy saving mode may turn off the network adaptor during periods of inactivity. Disable the energy saving mode to ensure the connection remains active.

4.1.4. Login page

If conditional access is needed, the Web RCS can be protected by a password.

 **More information**

See  Remote Access ^[p.51].

4.1.5. LivePremier Simulator

The LivePremier Simulator is available on www.analogway.com ^[http://www.analogway.com/].

Using the simulator, it is possible to simulate any LivePremier series multi-screen live presentation system on PC or Mac, and then launch the integrated Web RCS. It is the perfect tool to practice or rehearse when using a real unit is not possible. It is also a free opportunity to discover the Web RCS for the first time and learn the LivePremier concepts.

 **Tip**

Configurations created in the simulator can be exported / imported to a real unit, including the image library.

 **More information about using LivePremier Simulator**

See the Quick Start Guide available on www.analogway.com ^[http://www.analogway.com/].

4.2. General tips

4.2.1. Web browser features

The Web RCS is fully browser integrated and behaves like any web site.

It manages browser features such as:

- Previous page / Next page
- Multi-selection of items using the Ctrl or Shift keys
- Open in new tab / Open in new page
- Enter direct URL
- Bookmark any page
- Supports browser-based language translators

4.2.2. Mobile version

Prerequisite

To access the LivePremier with a mobile device, a wi-fi router must be connected on the same network as the LivePremier unit.

A lighter version Web RCS is also available on iOS and Android mobile devices without any installation needed.

To access the Web RCS from a mobile device, launch a web browser and enter the LivePremier IP address in the address bar.

This mobile version is simplified and has less features (no Preconfig or setup):

- Check device status
- Check rear panel connection status
- Check input video signals
- Load Master memories, Screen memories and Multiviewer memories
- Trigger transitions

Tip

For an optimized interface, do not display the mobile browser in Desktop mode.

4.2.3. Section buttons (copy, paste and reset)

On multiple pages of the Web RCS, the following buttons appear on hover:



These buttons are associated to a specific section. Use these buttons to quickly copy, paste or reset the settings of one section. Paste works when similar settings are currently copied (i.e. layer position copied to a different layer in a different screen).

4.2.4. Setting a number value

In the Web RCS, the fields for number values can be set and adjusted in different ways:

- Click and enter a number value.
- Click the field and hold then move the mouse left or right.
- Click and use the scroll wheel for small adjustments (mouse must remain in the field).
- Click the *Right* and *Left* arrows at the end of the field for single unit adjustment.

4.2.5. Search bar

In the top bar, use the search bar to simply access a feature or setting.

1. Click the search bar.
2. Enter a keyword to search (ex: Input, Pattern, Keying).
The search results are displayed.
3. Click a result to open the corresponding page.

4.2.6. Alarms and notifications

In the top bar, alarms and notifications display when the following events occur:

- A component is missing or not detected
- A component is not compatible with the current firmware version
- A high temperature has been detected (card, fan, or device alarm)
- Pending changes are waiting to be applied or not valid

Open the history log to check the history of alarms and notifications.

It is possible to mark notifications as read or clear them all.

Tip

On the device front panel, the buttons **Enter** and **Exit** blink when an alarm is triggered. The blinking stops when the alarm stops (ex: temperature becomes normal again).

4.2.7. Standby / Restart

In the top bar, click  then **Standby** or **Restart** and confirm.

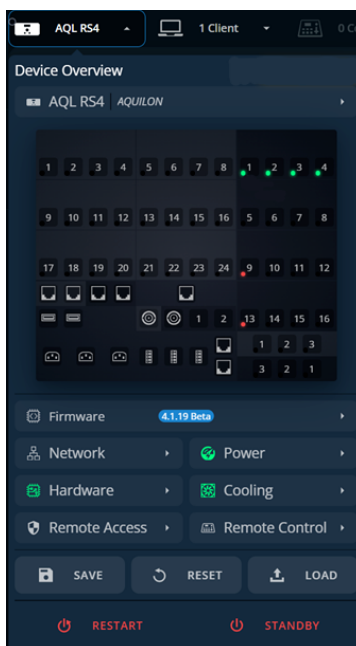

Settings access panel

Link settings access panel

The settings access panel for a **linked system** provides an access to a Device overview for each connected device individually and to a Dashboard providing a view of an entire linked system.

More information on Link

See  Appendix: LINK [p.193].

4.2.8. Back panel shortcuts

In the top bar, click  to show the virtual Back panel.

Click the connectors to access their settings directly.

Tip

Click **Renumber All** to update the I/O numbering if a number of available connectors was modified by replacing a card (e.g. Filler card or 8-HDMI card). Renumbering will restart the system and may affect the memories and other previous settings like inputs or backgrounds.

4.3. Device overview – system settings

Check a device status and modify network settings directly from the main page.

In the top bar, click  then:

- a device name for a Device Overview
- any item under the Back panel to access its settings directly.

In Device Overview

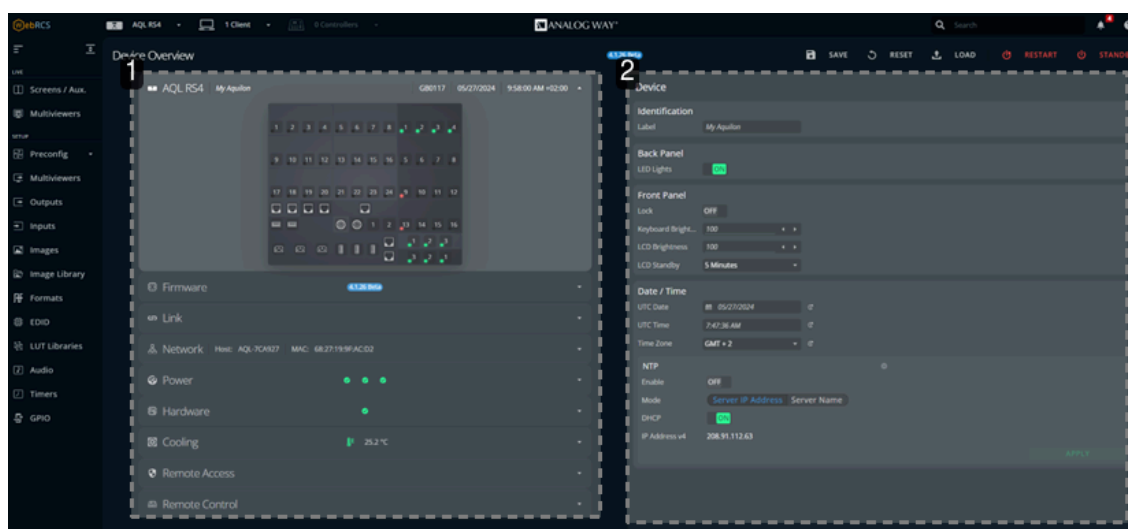

1. Left panel

Click on any item to open the corresponding settings on the right panel.

2. Right panel

Adjust the settings.

4.3.1. Device

Procedure

1. In **Identification**, enter a name for the device.
2. In **Back Panel**, toggle the LED lights button to enable / disable the LEDs on the unit back panel.
3. In **Front Panel**,
 - Toggle the **Lock** button to lock the front panel keys.
 - Set the Keys buttons Brightness.
 - Set LCD screen Brightness.
 - Set the LCD screen timeout before standby.

Caution

Disabling the LCD Standby may shorten the LCD backlight lifespan.

4. In **Date / Time**,
 - Set the device UTC Date and UTC Time. Click  to use local computer date or time.
 - If needed, set the Time Zone.
 - If using Network Time Protocol (**NTP**), toggle the enable button.
 - Select **Server IP Address** and enter an IPv4 address or use DHCP, then apply
OR select **Server Name** and enter a name, then **Apply**.

NTP protocol

The first connection can last a few minutes. If the connection fails, the settings are not applied.

4.3.2. Firmware

4.3.2.1. Update

Prerequisite

Download the latest LivePremier updater from www.analogway.com [<http://www.analogway.com/>].

Caution

Disconnect all HDMI over fiber cables from optical input plugs before a firmware update.

Note

In some cases, updating the LivePremier unit may reset the Configuration (check the Release notes).

 **Advice**

Export a configuration to recover it after the update (see  Save / Reset / Load Configuration ^[p.54]).

Procedure

1. Go to **Firmware**.

2. Load the updater file in the Web RCS using the file explorer or drag and drop.

3. Click **Install**.

The updater files are uploaded and extracted before the installation. During the Upload and Extraction steps, it is still possible to cancel the update if needed. After the installation, the LivePremier unit reboots.

4. If needed, import saved Configuration.

 **Recommendation**

Perform a default reset after a firmware update.

4.3.2.2. Reinstall current Firmware

When a firmware is installed, the LivePremier unit saves the installer of the current firmware in its memory. It is possible to reinstall the current firmware if needed (ex: update an input / output connector card).

1. Go to **Firmware**.

2. Click **Reinstall**.

The updater files are uploaded and extracted before the installation. During the Upload and Extraction steps, it is still possible to cancel the update if needed.

After the installation, the LivePremier unit reboots.

3. If needed, import saved Configuration.

 **Recommendation**

Perform a default reset after a firmware update.

4.3.3. Network

1. Go to **Network**.

2. In **Adapter**, set Host name.

3. In **IPv4**, manage DHCP, set IP address, Netmask, Gateway and DNS.

4. Click **Apply**.

5. If needed, enable and set **IPv6** and click **Apply**.

4.3.4. Power **Caution**

Always use same model of power supply units. If a new one is needed, ensure to use the same model.

1. Go to **Power**.
2. In **Mode**, set **Device switch ON** or **Device stay OFF** when connected to power or after a power failure.
3. Enable / disable Wake on LAN.

4.3.5. Hardware

Check the hardware configuration status. If an error occurs, check the status of all items in the right panel to identify the issue. If needed, download the configuration file for system check or technical support.

4.3.6. Cooling

Caution

If the device temperatures are too high, the device will automatically shutdown to prevent damages.

Check the Intake and Device Temperature. If any temperature is too high, two levels of alarms can appear: "abnormally high" and "dangerous".

Recommendation

- In case of alarms, check that nothing is covering the unit and that the air flow is not blocked.
- Clean the air filter regularly to prevent dust from blocking the air flow. For more information, see  User Maintenance and Troubleshooting ^[p.176].

4.3.7. Remote Access

In **Remote Access**, enable / disable password protection for the Web RCS and enable HTTPS Server.

4.3.7.1. Default Web RCS password

By default, the password to access the Web RCS is the LivePremier unit MAC address.

The MAC address is displayed on the front panel of the unit and in the Web RCS in **Device Overview > Network**.

Simulator

The default password for LivePremier Simulator is `11:22:33:44:55:66`.

4.3.7.2. Enable Web RCS password protection

Note

Enabling password protection will disconnect all Web RCS pages currently opened.

1. Go to **Remote Access > Basic Authentication**.
2. Toggle the enable button.
3. Click **Apply**.
All opened Web RCS sessions are locked and return to a login page.

4.3.7.3. Lock an opened Web RCS session

To lock a session after logging in, close all instances of the web browser and the web browser.

Or

Click on  if the password protection was enabled, to lock all instances at once.

Tip

Reopen the web browser and try to access the Web RCS to make sure the session is locked.

4.3.7.4. Change Web RCS password

1. Go to **Remote Access > Change password**.
2. Enter the new password.
3. Enter the same password to confirm.
4. Click **Apply**.

4.3.7.5. Reset Web RCS password from the front panel

If the password is lost or forgotten, it can be reset from the front panel of the LivePremier unit.

1. On the front panel, go to **Control**.
2. Go to **Reset Settings**.
3. Go to **Reset Auth. Password**.
4. **Apply**.

The Web RCS password is reset to default value (device MAC address).

4.3.7.6. Enable / Disable HTTP and HTTPS on the Web RCS

The LivePremier supports HTTPS protocol. It is possible to enable / disable HTTP and HTTPS.

Port

Make sure port 443 is available on your network and/or not blocked by firewall to use HTTPS.

Tip

If the Web RCS is not accessible, use the front panel to re-enable the HTTP Server, see  Reset HTTP and HTTPS settings ^[p.53].

1. Go to **Dashboard > Remote Access**.
2. In **HTTP Server**, toggle the enable button for HTTP.
3. In **HTTPS Server**, toggle the enable button for HTTPS.
4. Click **Apply**.

If HTTP has been disabled, the current page will be disconnected from the Web RCS.

Use **https://** before the device IP address to access the Web RCS in HTTPS (**https://192.168.2.140** by default).

4.3.7.7. Import custom HTTPS certificate

It is possible to import a private certificate and key to secure the connection to the device.

Port

Make sure port 443 is available on your network and/or not blocked by firewall.

1. Go to the Dashboard > **Remote Access**.
2. In **Current Certificate & Key**, load the certificate and private key files in the Web RCS using the file explorer or drag and drop.
3. Click **Upload**.
4. Click **Apply**.

4.3.7.8. Reset HTTP and HTTPS settings

The HTTP and HTTPS settings can only be reset from the front panel.

1. On the front panel, go to **Control**.
2. Go to **Reset Settings**.
3. Go to **Reset HTTP/HTTPS Servers**.
4. **Apply**.

The Web RCS HTTP and HTTPS settings are reset to default value (HTTP On and HTTPS Off).

4.3.8. Remote Control

In **Remote Control**, enable / disable Web RCS control via RC400T, external USB controllers or APIs.

1. Go to **Remote Control**.
2. In **RC400T Controllers**, enable / disable RC400T connection to the LivePremier unit.
3. In **External USB Controllers**, enable / disable Controllers connection to the LivePremier unit.
4. In **Application Programming Interfaces**, enable / disable LivePremier control via AWJ Protocol or REST API.

Note

- The network ports used for RC400T and AWJ are displayed on the Remote Control card.
For more information about RC400T, see  Appendix: RC400T ^[p.178].
- AWJ is a JSON based protocol developed by Analog Way for LivePremier. AWJ is a bidirectional TCP API, it grants full control on a LivePremier device and receives real-time status updates from the LivePremier device. For more information, visit www.analogway.com ^[http://www.analogway.com/].

4.4. Save / Reset / Load Configuration

Tip

Saving the configuration before powering off is not necessary. The unit saves the current configuration in real time.

The LivePremier units can export and import device configurations.

In addition to these features, the LivePremier units also have two embedded memory slots for saving and loading configurations internally.

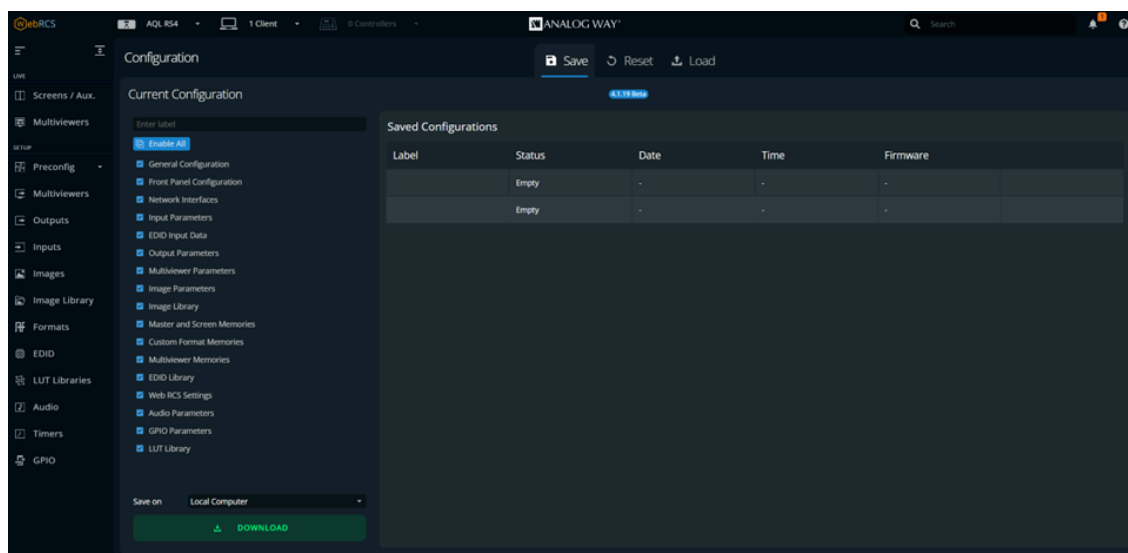

Save / Reset / Load Configuration

Library size

The size of the image library cannot exceed 950MB to be imported / exported.

4.4.1. Save the current Configuration

1. In the top bar, click , then **Save**.
2. Enter a label for the Configuration to save.
3. In the filters, select the settings to save.
4. Select the destination and click **Download** or **Save**.

The configuration is downloaded on the local computer or saved in the selected memory slot.

4.4.2. Reset a Configuration

1. In the top bar, click , then **Reset**.
2. Select the reset mode:
 - **Default Reset**: Select the settings to be reset to default value.
 - **Out of the box**: Factory reset. All settings are reset to default value.
3. Click **Reset**.

The LivePremier unit resets.

Recommendation

Perform a default reset after a firmware update.

4.4.3. Load a Configuration

1. In the top bar, click , then **Load**.
2. In the **Load** panel, select the slot to load.
Or

Drag and drop the configuration file from the computer file explorer to the upload area.
The configuration is extracted and conflicting settings are grayed out in the filters (version incompatibility, obsolete information, device logs, etc.).

3. In the filters, select the settings to load.
4. Select how to merge the images in the Library.

Merge and replace	Merge and replace images in non-empty slots
Merge without replacing	Merge but keep images in non-empty slots
Replace current Image Library	Replace the entire device library with the import library

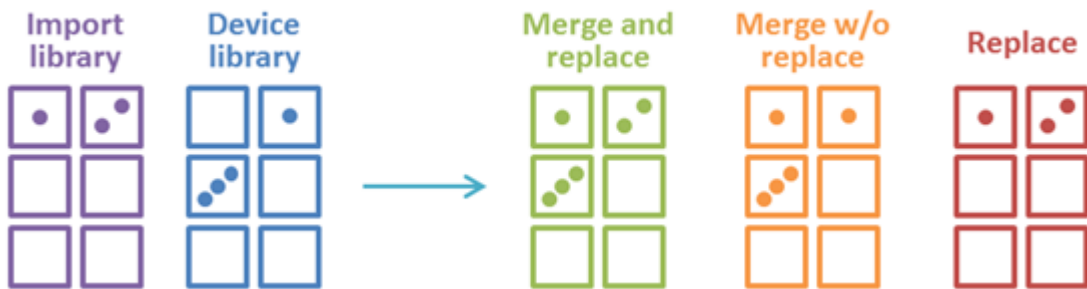

5. Click **Apply Device**.

The configuration is loaded to the Web RCS and applied to the current configuration.

4.5. Device control synchronization

A LivePremier device can be connected to up to 5 control instances (multiple Web RCS pages, RC400T, etc.). It is possible to enable / disable the synchronization of each control instance with the server from the Web RCS.

When a control instance is synchronized with the server, the layer selection and the selection of Screens affected by transitions are applied to all other synchronized control instances (Web RCS page, RC400T, etc.).

Tip

By default, synchronization to server is disabled on all instances to work without other instances changing the layer selection or the selection of Screens affected by transitions.

4.5.1. Web RCS synchronization

1. In the top bar, click .

The sync status of the current Web RCS page is displayed as well as the number of currently opened Web RCS pages.

2. Toggle **Selection Synced to Server** to enable / disable synchronization to other control instances.



Web RCS synchronization

4.5.2. RC400T synchronization

1. In the top bar, click  or select the Virtual RC400T in the Live menu.

The sync statuses of the connected RC400T controllers are displayed.

2. Toggle **Selection Synced to Server** to enable / disable their synchronization to other control instances.



RC400T synchronization

Note

Program and Preview Screens that are protected by lock in the Web RCS cannot be modified by the RC400T when synchronized with server. Layers cannot be modified; Memories cannot be loaded but transition can be triggered.

For more information on Screen lock

See  View filters – Top bar buttons ^[p.140].

5. LivePremier concepts

5.1. Capacity

Capacity

A capacity is the maximum bandwidth allocated to an item. Allocating a max capacity for every item ensures the interoperability between all the internal elements of a LivePremier unit. Capacities are automatically assigned when setting a format.

The range of the capacity is from **1** to **8**. The minimum capacity (**1**) refers to dual-link bandwidth. Each following capacity adds the resource equal to dual-link bandwidth. The maximum capacity (**8**) refers to 8K bandwidth.

5.1.1. Standard formats capacity

Commonly used formats and their corresponding capacity

Capacity 1 with internal rate at 60Hz	Capacity 2 with internal rate at 60Hz
1920 x 1080 @ 60Hz (HDTV 1080p60)	4096 x 2160 @ 30Hz
2560 x 1600 @ 60Hz	3840 x 2160 @ 60Hz (UHDTV 2160p60)
1920 x 1080 @ 120Hz	Between 1920 x1080 and 2560 x1600 @ 120Hz
Any format below 2560 x 1600 @ 60Hz	Any format above 2560 x 1600 @ 60Hz

How it works

- Capacity depends on the device internal processing rate. The higher the internal rate, the more processing capacity will be required.
- 4096 x 2160 @30Hz can be used as capacity 1 if the internal rate of the unit is set at 30Hz.
- Some video formats and image resolutions are not supported when the internal rate is higher than 60Hz.

More information

See  Vertical rate.

5.1.2. Elements using capacity

Capacities are automatically assigned when setting a format for:

Inputs groups	Image slots	Layers	Screen output groups
Capacity 1	Capacity 1	Capacity 1	Capacity 1
Capacity 2	Capacity 2*	Capacity 2	Capacity 2

+ Image slots

* Setting an image slot to capacity 2 disables the next image slot.

5.1.3. Content and layer compatibility

An input or image with capacity 1 can be used in a layer with capacity 1 or 2:



*Content with capacity 1:
1920x1080*



In layer with capacity 1: 1920x1080



In layer with capacity 2: 3840x2160

Result

The content is displayed correctly in both layers but the resources are not optimized.

An input or image with capacity 2 can only be used in a layer with capacity 2:



*Content with capacity 2:
3840x2160*



In layer with capacity 1: 1920x1080



In layer with capacity 1: 3840x2160

Result

The content cannot be displayed in layer with capacity 1 due to insufficient layer capacity.

Note

If a 1920x1080 content is set to capacity 2, it will be displayed in a layer with capacity 2.

5.2. Screen layers

Layers are assigned to Screens and Aux Screens in the **Preconfig** menu of the Web RCS.

LivePremier features two layers modes exclusively for Screens:

- Mixing layers
- Split layers

Note

A Screen contains either mixing layers or split layers. Never a combination of both.

5.2.1. Screen sources

Screen and Aux Screen layers can display the following types of content:



Inputs



Images (including timers)



Backgrounds



Screens

 **Note**

- Screens can only be used as content for Aux Screens and Screens in Split layer mode.
- Backgrounds can only be used in Screen Background layers.

 **NDI stream**

It is possible to use an NDI stream as an input. For more information on how to set up an NDI input see

 IP/SDI ^[p.98].

5.2.2. Mixing layers

This is the default layer mode for LivePremier units as well as most Analog Way products. Mixing layers support cross transitions with both contents visible at the same time during the transition (seamless transition).

 **Note**

A mixing layer cannot display a Screen.

5.2.3. Split layers

This layer mode consumes half the processing resources compared to mixing layers and doubles the number of layers available on Screen.

Split layers are created by pairs with same resource consumption (capacity **1** or **2**, use of Cut & Fill).

 **In split layers mode:**

- A **Program Screen** can be displayed in a layer (may use resources of following layers and preempt them).
- Seamless transitions are not possible, one content will disappear before the new one is visible.
- When using a Multiviewer to view the Preview of a Screen using split layers, only layer wireframes are displayed.

5.3. Aux Screens and Aux layers

Aux Screens do not consume processing resources. They are a great help to display more content when the LivePremier unit has available outputs while processing resources are fully used by Screens.

5.3.1. Aux layers quantity and capacity

Outputs used in Aux Screens can display up to 8 layers with capacity 1.

The Aux layer quantity follows two rules:

- Enabling more than 2 layers disables the next output plugs on the card as it uses their resources.
- Aux layers are dynamic. After the Aux Screen is created, assigning a content with a capacity higher than 1 will preempt the next Aux layer(s). Each additional capacity = one layer preempted.

Example

An Aux Screen is set with 6 layers.

- Assigning a 7860x2160 Program Screen (capacity 4) to layer 1 will preempt layer 2, 3 and 4.
- Layer 5 and 6 remain available.

Aux output layer quantity	Max source capacity if displaying only one layer
2 layers capacity 1	Capacity 2 (can display a 4K Screen)
4 layers capacity 1 (disables the next output slot)	Capacity 4 (can display a 2x 4K Screen)
6 layers capacity 1 (disables the next two output slots)	Capacity 6 (can display a 3x 4K Screen)
8 layers capacity 1 (disables the next three output slots)	Capacity 8 (can display a 4x 4K Screen)

Tip

- Only outputs 1, 5, 9, 13 and 17 can be set as Aux Screens with 8 layers as this uses the resources of the next three outputs of the card. Connect outputs according to these limitations.
- An Aux with 8 layers has enough bandwidth to display an 8K Program, but the output plug format is still limited to 4K@60Hz.

5.3.2. Aux layers limitations

Aux layers support most of the same features as Screen split layers:

- input
- image/timer
- screen program as source
- size, position, crop, timings, etc.

Aux layers do not support:

- Seamless transitions, one content will disappear before the new one is visible.
- Alpha channels, transparent content is displayed in the same color as the background layer.
- Border settings.
- Cut & Fill effect.
- Layers freeze.

Aux background

The Aux background layer can only support one monochrome color as a source (no input, image or background set).

5.4. Screen / Aux Screen comparison

Screen / Aux Screen comparison

Feature supported	Screen with layers	Screen without layers	Aux Screen
Multiple outputs	Yes	Yes	No
DPH104 output	Yes	Yes	No
Multiple layers	Yes	No	Yes
Consume zero processing resources	No	Yes	Yes
Background layer (with eight Background Sets using inputs or images)	Yes	Yes	No. Monochrome color only.
Display a Screen Program	Yes	No	Yes
Layer border settings	Yes	No	No
Alpha channels	Yes	Yes. With custom monochrome color.	No
Cut & Fill effect	Yes	No	No
Seamless transitions	Yes	Yes	No

5.5. LivePremier Processing

5.5.1. VPUs and Scaling engines

Understanding VPU concept is the key for optimized performance.

Video Processing Units

≈ VPU

VPUs are the main processing components of LivePremier. They create the layers and allocate them to one or multiple outputs.

Important

Each VPU contains 8 source links and 8 outputs links.

Capacity 1 uses one link and capacity 2 uses two links.

Each VPU supports:

- 8 mixing layers (or 8 pairs of split layers) spread over 8 outputs, in capacity 1.
- 4 mixing layers (or 4 pairs of split layers) spread over 4 outputs, in capacity 2.

Representations of a VPU

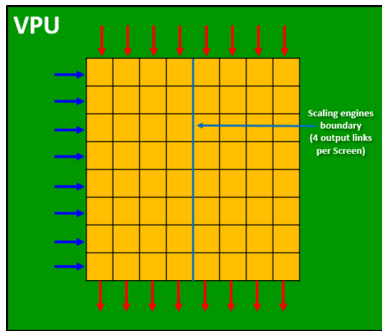

VPU with full capacity 1

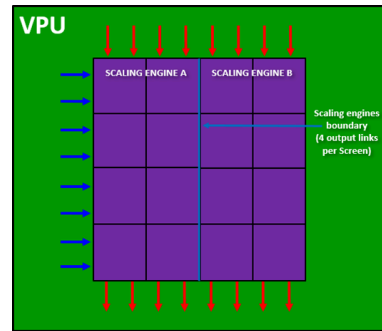

VPU with full capacity 2

5.5.2. Self-rearrangement

A VPU has a modular architecture and rearranges its links depending on the Screen configuration:

- Number of outputs in the Screen
- Number of layers in the Screen
- Capacity of the links between layers and outputs

👁️ VPU configuration examples

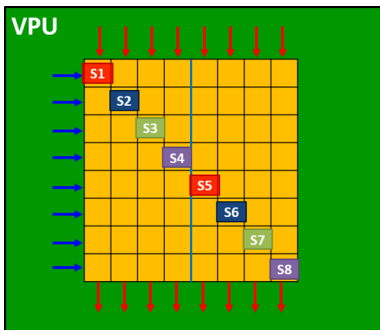

One VPU can manage up to 8 Screens, each Screen using 1 output and 1 mixing layer

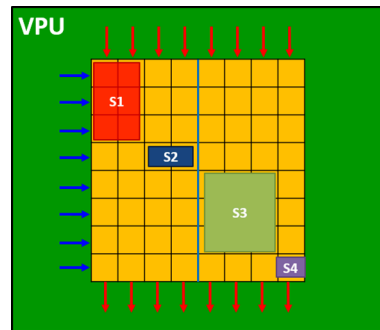

One VPU can manage various combinations within the 8x8 links limits

5.5.3. VPU capacities support

📌 Important

A VPU can support both capacities at the same time

One Screen cannot support mixing and split layers at the same time. However, VPUs and Screens can support layers of capacity 1 and 2 at the same time, in any order.

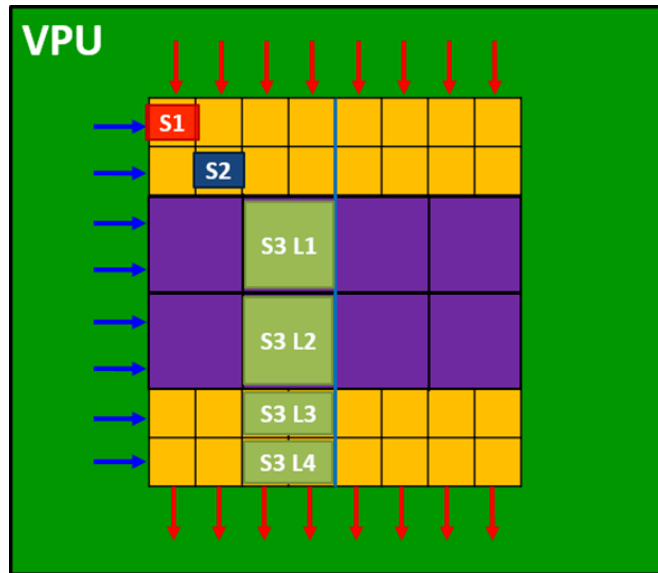

+ In detail

Screen 1:

- 1 output
- 1 mixing layer capacity 1

Screen 2:

- 1 output
- 1 mixing layer capacity 1

Screen 3:

- 2 outputs
- 2 mixing layers capacity 2
- 2 mixing layer capacity 1

5.5.4. Scaling engine boundary

Important

A VPU is optimized to spread layers over up to 4 output links.

A layer spread over more than 4 output links uses another layer link.

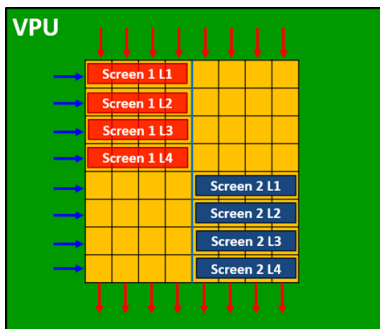

Two Screens of 4 outputs with 4 mixing layers each

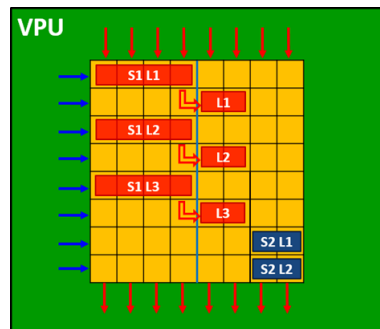

*Screen 1 (6 outputs and 3 mixing layers)
Screen 2 (2 outputs and 2 mixing layers)*

5.5.5. Combined VPUs

A Screen using more than 8 outputs uses another VPU.

Example

Each mixing layer of Screen 1 uses 3 layer links:

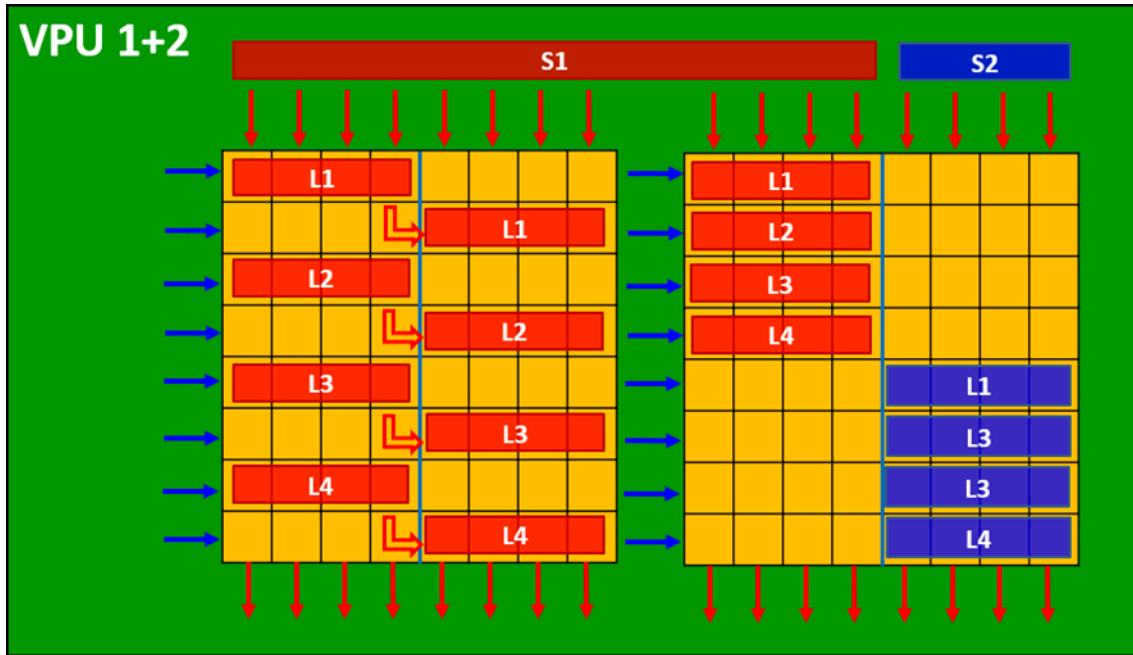

In detail

- | | |
|---|--|
| Screen 1: | Screen 2: |
| <ul style="list-style-type: none"> • 12 outputs • 4 mixing layers | <ul style="list-style-type: none"> • 4 outputs • 4 mixing layers |

5.5.6. Optimized mode

An Optimized mode is enabled for the whole VPU when one Screen uses at least 5 outputs links and at least one layer of capacity 2.

The Optimized mode removes the 4 links boundary and configures the links to bring the best performance for layers of capacity 2.

Recommendation

When Optimized mode is enabled in one Screen, use only layers of capacity 2.

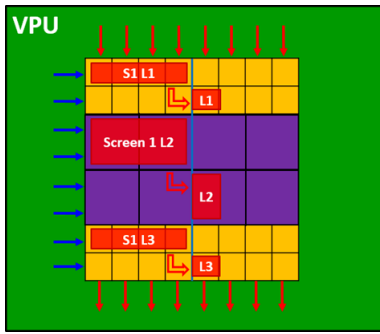

Without Optimized mode

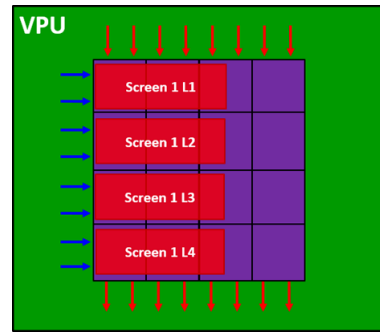

With Optimized mode

+ In detail

Screen 1:

- 5 outputs
- 2 mixing layers capacity 1
- 1 mixing layer capacity 2

Screen 1:

- 5 outputs
- 4 mixing layers capacity 2

5.5.7. Cut & Fill resources

The Cut & Fill effect enabled for a layer doubles the resources needed for that layer.

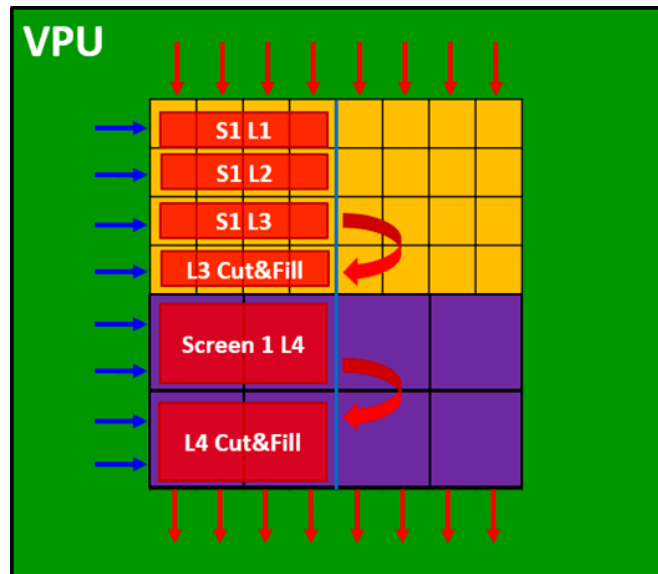

+ In detail

Screen 1:

- 4 outputs
- 2 mixing layer capacity 1
- 1 mixing layer capacity 1 with Cut & Fill
- 1 mixing layer capacity 2 with Cut & Fill

5.5.8. How many VPUs per model?

Tip

LivePremier units are equipped with up to 4 VPUs.

Aquilon Models	VPU	Output connectors	Max 4K60p PGM outputs (capacity 2)	Max 4K60p mixing layers (capacity 2)	Max DL/2K60p split layers (capacity 1)
RS alpha	1	4	4 Screens + 0 Aux	4	16
RS1	1	8	4 Screens + 4 Aux	4	16
RS2	2	12	8 Screens + 4 Aux	8	32
RS3	2	12	8 Screens + 4 Aux	8	32
RS4	3	16	12 Screens + 4 Aux	12	48
RS5	3	16	12 Screens + 4 Aux	12	48
RS6	4	20	16 Screens + 4 Aux	16	64
C	up to 2	up to 16	8 Screens + 8 Aux	up to 8	up to 32
C+	up to 3	up to 20	12 Screens + 8 Aux	up to 12	up to 48
Cmax	up to 4	up to 24	16 Screens + 4 Aux	up to 16	up to 64

Note

VPUs are automatically joined together just like scaling engines depending on the Screen configuration.

5.5.9. IPU

Image Processing Units

≈ IPU

IPU components create the image content.

Important

One IPU supports:

- up to 24 simultaneous images of capacity 1 displayed on Program
- up to 12 simultaneous images of capacity 2 displayed on Program

Image capacities

- Images of capacity 1 and 2 can be displayed at the same time.
- When an image slot is set to capacity 2, it uses the resources of the next preset and preempts it.

AquilonModels	IPU	Simult. 4K image channels
RS alpha	1	12
RS1	1	12
RS2	1	12
RS3	2	24
RS4	2	24
RS5	2	24
RS6	2	24
C	0 or 1	0 or 12
C+	Up to 2	Up to 24
C max	Up to 2	Up to 24

5.6. HDR conversion

Important

HDR conversion adds no latency.

LivePremier can manage inputs and outputs with different frame rates. In the same way, LivePremier can also manage inputs and outputs with different dynamic range profiles, including Standard Dynamic Range (SDR) and High Dynamic Range (HDR).

HDR conversion manages:

- SDR ↔ HDR10
- SDR ↔ HLG
- HDR10 ↔ HLG

The LivePremier processing engine supports HDR10 and HLG standards. SDR to HLG conversion is based on professional 3D lookup tables (LUTs) by BBC.

The user can define an internal HDR profile and all inputs will be automatically converted for optimized processing and display. HDR conversion can also be manually set for each image slot, input and output.

It is also possible to import custom LUTs to use for dynamic range conversion at the input or output level.

Note

HDR conversion means all content can be converted to be mixed and displayed perfectly. This does not mean SDR content will look better when converted to HDR.

More information on dynamic range settings

See *LivePremier LUT Architecture* application note available on

www.analogway.com [<http://www.analogway.com/>]

5.7. LivePremier latency

The LivePremier series has been optimized to offer extremely low latency, in most cases between 1 and 2 frames.

More information

See the White paper (Training & Support) explaining LivePremier latency available on www.analogway.com [http://www.analogway.com/].

6. Preconfig Menu

Preconfig submenus

Click  Preconfig to display the submenus.

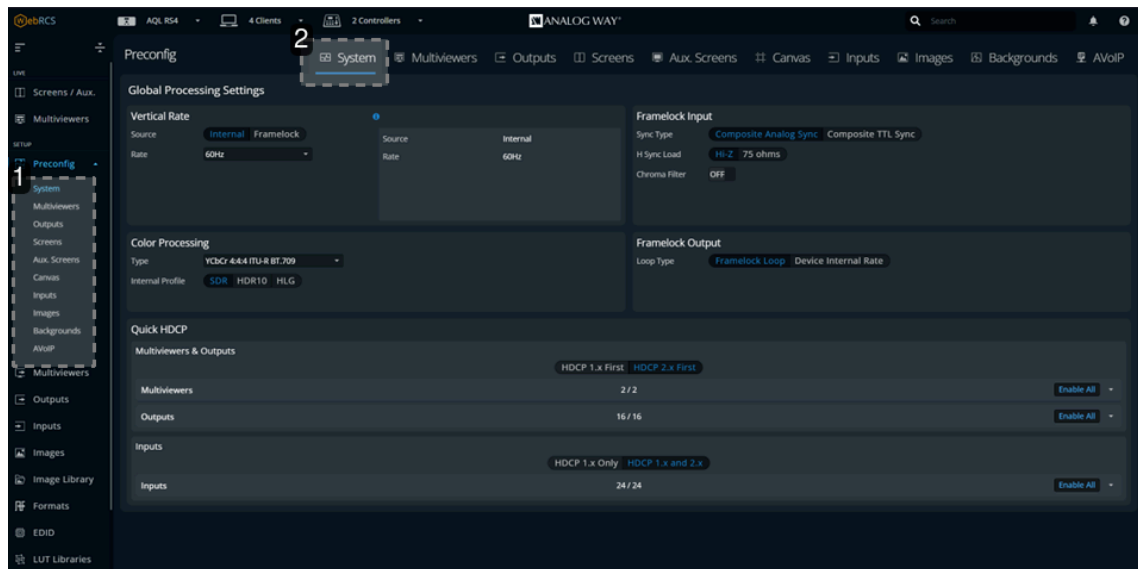

1. Preconfig submenus



System



Multiviewers



Outputs



Canvas



Inputs



Images



Backgrounds



AVoIP

2. Current submenu : System

6.1. Preconfig > System

Set internal rate, framelock, color space and quick HDCP.

6.1.1. Vertical rate

Vertical rate

Sets the overall internal operating frame rate of the unit, which defines the frame rate of all Program outputs.

Vertical rate can be set manually, or by following a Genlock or Framelock as a reference.

Caution

If the Internal rate is set strictly above 60Hz, some output formats and image resolutions may not be supported; and input resolutions beyond 2560x1600 will not be supported no matter the incoming frame rate.

6.1.1.1. Set defined rate

1. In **Vertical Rate > Source**, click Internal.
2. In **Rate**, select the refresh rate.

6.1.1.2. Set relative rate

Caution

Make sure the reference input is a reliable source.

Any disruptions in the reference signal may cause visible glitches on the output, even if the selected framelock reference input is not being displayed.

1. In **Vertical Rate > Source**, click Framelock.
2. In **Reference**, select Framelock or the Input to be the refresh rate reference.
3. In **Factor**, select **x0.5**; **x1** or **x2**.

The "reference rate x rate factor" must be between 22Hz and 120Hz.

6.1.2. Framelock input settings

Tip

These settings are applied when Framelock is set as Vertical rate.

Set the framelock sync settings according to your video sync setup.

Setting name	Description / Setting selection
Sync Type	Composite Analog Sync or Composite TTL Sync
H sync Load	Hi-Z or 75 ohms
Chroma Filter	On/Off toggle Filters the chroma for better synchronization when using a composite video signal as framelock input

6.1.3. Framelock output settings

Set the Framelock output to:

- Loop the Framelock
or
- Output the internal rate of the unit.

6.1.4. Color processing

Set the general color space and dynamic range used for processing.



Tip

BT.709 is recommended for HD and **BT.2020** is recommended for 4K / UHD.

Setting name	Description / Setting selection
Type	Select the general color space used for processing: <ul style="list-style-type: none"> • YCbCr 4:4:4 ITU-R BT.709, or BT.709 Limited range • YCbCr 4:4:4 ITU-R BT.2020, or BT.2020 Limited range
Internal Profile	Select the Dynamic range used for processing : <ul style="list-style-type: none"> • SDR, HDR10 or HLG
Luminance	In HDR10 , select the nit level used for processing



Output color space

The output color space is set per output in the Output menu. For more information, see [🔗Outputs](#) ^[p.104].

6.1.5. Quick HDCP

Quickly enable / disable HDCP for all inputs and outputs.



Note

Disabling HDCP reduces potential problems when the content is not fully HDCP compliant. When output HDCP is disabled, HDCP inputs will not be displayed anymore.

1. Set the mode to **HDCP 1.x First** or **HDCP2.x First** for **Multiviewers &Outputs** and **Inputs**.
2. Toggle the enable button.
Or
Open the list of connectors and select manually connectors to enable / disable HDCP.



Result

The connectors highlighted in **Blue** are currently enabled.

6.2. Preconfig > Multiviewers

6.2.1. Multiviewer

A Multiviewer is a dedicated output displaying a user customizable selection of Widgets as display resources to monitor content. One Multiviewer can display up to 64 Widgets.

A **Widget** is a Multiviewer layer containing a program, preview, input, image or timer.

6.2.2. Multiviewers quantity

A LivePremier unit can use One Multiviewer (64 Widgets in total) or Two Multiviewers (128 Widgets in total). By default, Two Multiviewers are enabled.

1. Click on first Multiviewer and choose the format:

Two Multiviewers	<ul style="list-style-type: none"> ◦ Max output resolution per Multiviewer is 2560x1600@60 or 4K@30 ◦ Up to 128 widgets
One Multiviewer	<ul style="list-style-type: none"> ◦ Max output resolution is 4K@60 ◦ Up to 64 widgets ◦ Can be duplicated on the second Multiviewer plug

2. Click **Apply** to save the new configuration.

Duplication

In case of duplication, *Format* and *Adjustment* settings change on one Output is also applied to the other output.

6.2.3. Set a DPH104 for a Multiviewer DP output

A LivePremier device can be equipped with two DisplayPort 1.2 Multiviewers outputs instead of HDMI 2.0.



Preconfig > Multiviewers

1. Choose one Multiviewer or two Multiviewers.
2. In **DPH104 Slicer**, toggle on to enable the Slicer for the corresponding Multiviewer output.
3. Set the format applied to every output of the DPH104.

Output resolutions supported by the DPH104

- 4x 1600x1200
- 4x 1920x1080
- 4x 1920x1200

Additional settings

Can be further adjusted in  **Multiviewers**.

6.3. Preconfig > Outputs

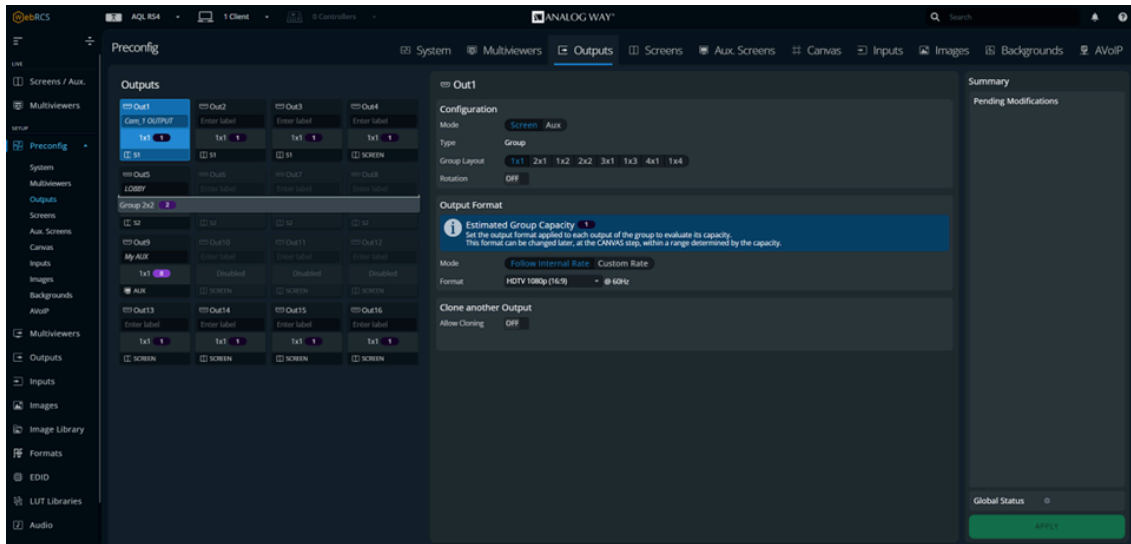

Preconfig – Outputs

Set:

- output groups, output rotation and output group format
- a DisplayPort output as using a DPH104
- output clone and aux duplication.

Note

Output rotation is enabled in  Preconfig > Outputs and then set in  Preconfig > Canvas.

The Cut & Fill effect is set for a layer (or pair of split layers) during the layer allocation as it requires VPU resources.

6.3.1. Output capacity – The 4-4 rule

A LivePremier unit is equipped with one, two, three or four Video Processing cards (VPU). For detailed information, see [How many VPUs per model?](#) [p.67].

Output resources are impacted by format (resolution and rate). LivePremier units have a limited number of Program outputs depending on the capacity set for these outputs.

One VPU supports:

- **4x** capacity 2 program outputs
AND
- **4x** capacity 2 mixing layers

Tip

The remaining outputs that are not used as Program can be used as Aux.

6.3.2. Output group

Output group

Grouping outputs optimizes the processing resources of the VPU for Screens with multiple outputs. It allows the use of more outputs in the same VPU (ex. one VPU can manage up to 16 outputs in four 2x2 Screens).

How it works

- An output can only be grouped with the following output in the same output card.
- It is possible to group up to four outputs together.
- The group leader is always the output with the lowest number:
For example if output 7 and 8 are grouped together, then output 7 is the leader and output 8 is set as *Grouped*.

Note

When grouped together, every output must have the same format and the group bandwidth is limited to capacity 2 (total pixel space is limited to 4096x2160).

Output group examples:

- one output at 3840x2160
- two outputs at 4096x1080
- four outputs at 1920x1080

Background content optimization

It is possible to set a 4K image or live input as background content for an output group composed of four HDTV outputs.

The content used in background does not need to be divided beforehand as this is performed by the LivePremier unit.

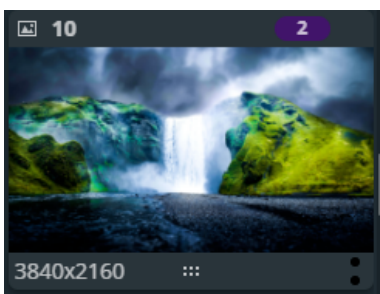
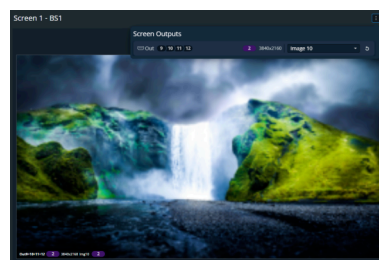

Image 4k (3840x2160)



BS of 4K screen composed of 4 HD screens

Note

- By default, all outputs are set in a 1x1 group.
- Rotation is possible for the output group but not for independent outputs inside groups.
- Individual output settings are still available in the Output menu (color space, patterns, HDCP, audio channels, etc.).
- Using a group of two or more outputs adds a one frame latency.

6.3.3. Set an output group for a Screen



Preconfig > Outputs

1. In **Configuration**, select **Screen** mode and **Group** type.
2. Select the output group layout (**1x1** by default).
Selecting a higher group layout automatically groups the following output(s).
3. If needed, enable rotation for the output group.
4. In **Output Format**, set the format applied to every output of the group.
Capacities are automatically assigned when setting a format.

Latency and rotation

- Using a group of two or more outputs adds a one frame latency.
- Enabling output rotation adds a one frame latency.
- Using both rotation and multi-output group at the same time only adds one frame latency.
- Enabling output rotation for a 1x1 output with capacity 2 disables the next output plug.

For more information on output rotationSee  Set output rotation ^[p.83].

6.3.4. Set a DPH104 output for a Screen

Good to know

If the internal rate is set to 30Hz or less, an output with a DPH104 is set to capacity 1.

This means an Aquilon Cmax with 24 DPH104 can feed up to 96 1920x1080@30 displays.



Preconfig > Outputs

1. In **Configuration**, select **Screen** mode and **DPH104 Slicer** type.
2. Select the Layout (**4x1**; **2x2** or **1x4**).
3. If needed, enable rotation for every output of the DPH104.
4. In **DPH104 Format**, set the format applied to every output of the DPH104.

Output resolutions supported by the DPH104

- 4x 1600x1200
- 4x 1920x1080
- 4x 1920x1200

6.3.5. Set an output for an Aux Screen



Preconfig > Outputs

1. Click an output.
2. In **Configuration**, select **Aux** mode.
3. Select the Layer quantity (**2** by default).
Selecting a higher layer quantity automatically preempts the following output(s).
4. In **Output Format**, set the format applied to the output.

6.3.6. Output cloning and Aux output duplicate

All outputs can reuse the content from other outputs to send an identical signal while saving processing resources.

6.3.6.1. Output cloning

An output clone will send the same signal as another output without consuming processing resources.

Output cloning limitations

An Output clone cannot:

- be affected to any Screen or Aux Screen
- clone a Screen, only another output group of the same type or size
- clone a signal that it cannot support (insufficient bandwidth, audio, HDCP, 4:4:4, etc.)
- clone an output used as Aux (use Aux output duplication).



Preconfig > Outputs

1. Select an output and set it just like the clone source.
2. In Clone, toggle **Allow Cloning** to enable the duplication.
3. Select the Clone source output group.
The same content will be sent through the output source and the output clone.

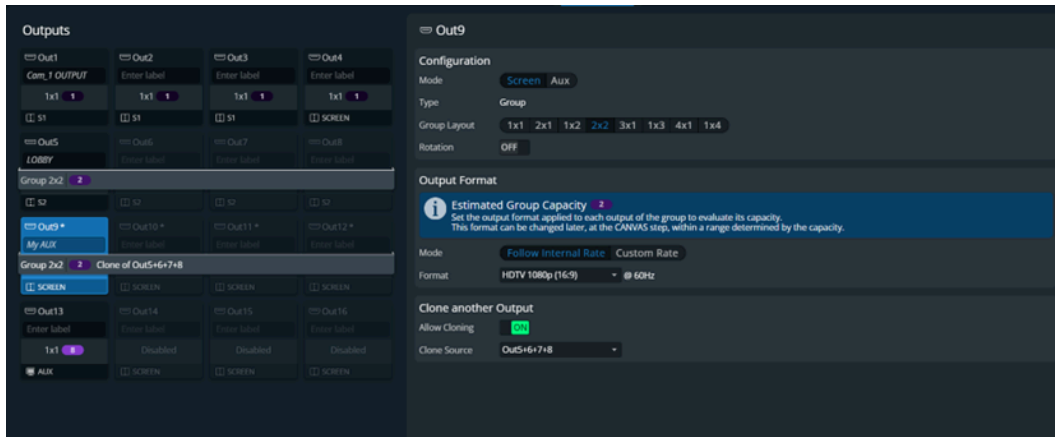

Output clone (ex: group Out9-12 is a clone of group Out5-8 used in Screen 2)

6.3.6.2. Aux output duplication

When an output is set to Aux mode with **4** or more layers, the following output(s) are preempted. These outputs become disabled by default, but they can be set to duplicate the content of the preempting Aux output.

Note

In case of duplication, *Format* and *Adjustment* settings change on one Output is also applied to the other output.



Preconfig > Outputs

1. Set an output to **Aux** mode with 4 or more layers.
The next output(s) are disabled.
2. In Output Duplication, toggle **Allow on Output X** to enable the duplication.
The same content will be sent through the main Aux output and the output with duplication enabled.

Option

It is also possible to enable / disable the duplication when selecting the target output.

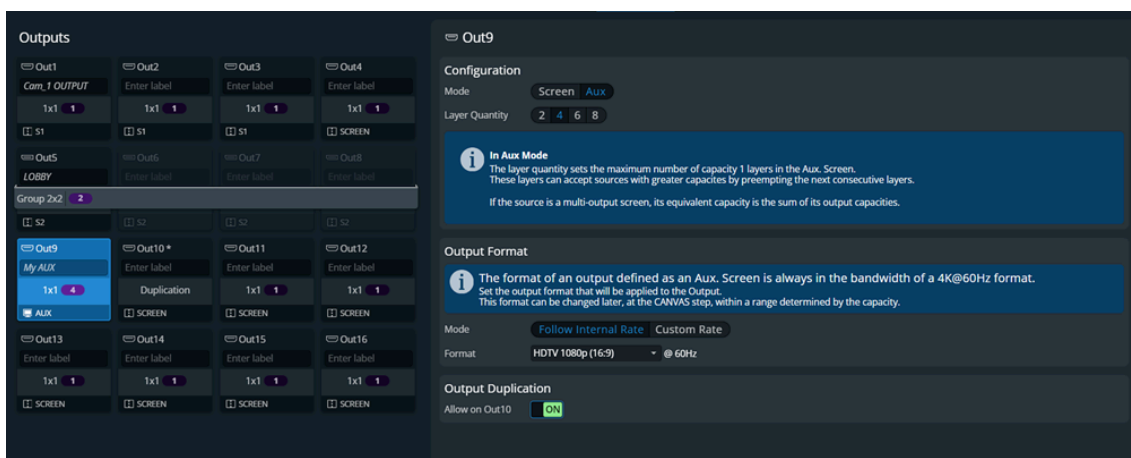

Aux output duplication, the same signal is sent on Out10

6.3.7. Creating Screens

6.3.7.1. Screen regions

By default, all layers can be displayed on every output of a Screen.

Set Screen regions to optimize layer resources by limiting layers to specific outputs of a Screen.

Note

One output can be assigned to only one region and one layer can be assigned to one or more regions.

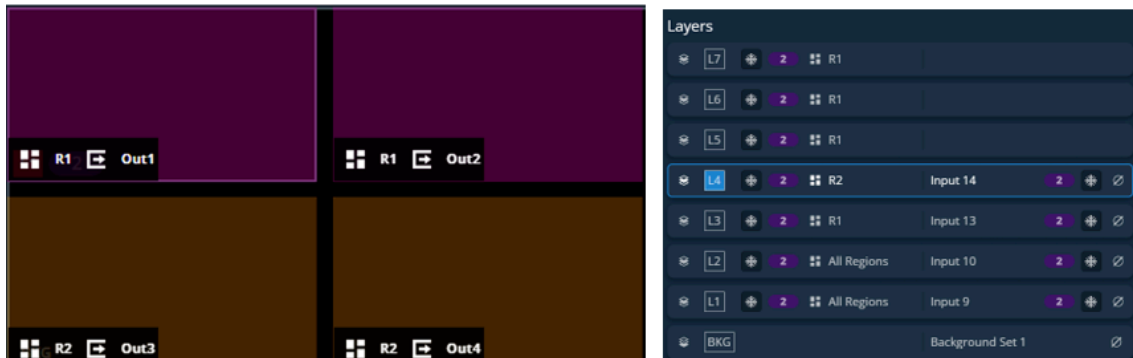

Out1+2 are in R1 and Out3+4 are in R2; L3 and L4 are limited to R1 and R2

6.3.7.2. Create a Screen



Preconfig > Screens

Prerequisite

An output group must be set to **Screen** mode to be assigned in a Screen.

Procedure

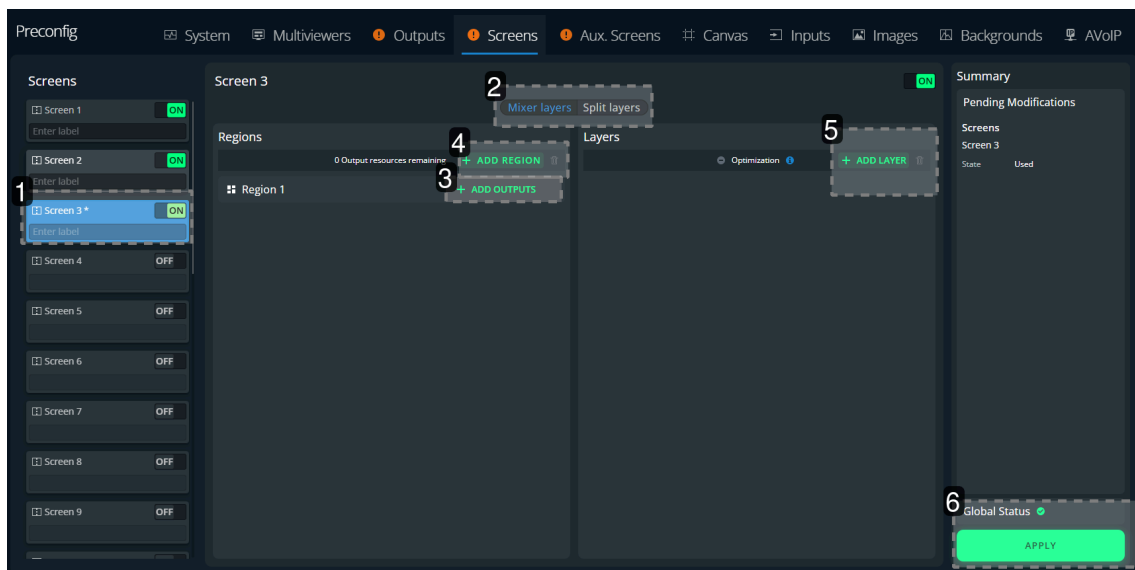

1. Enable the Screen and, if needed, enter the label.
2. Select the Layer mode (Mixing layers or Split layers).

3. Click on Add Outputs.

Select the outputs for Region1 (by default) and click on Add Outputs.



4. OPTIONAL: Add regions.

Repeat step 3 to assign outputs to this region.

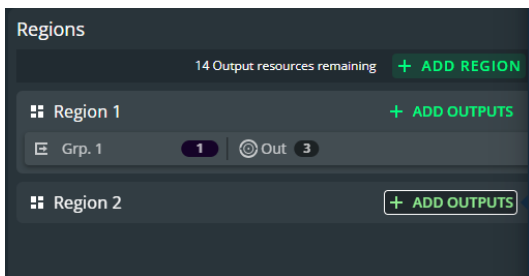

 **To remove outputs**

Click on .

5. Add Layers

and assign them to regions if needed.

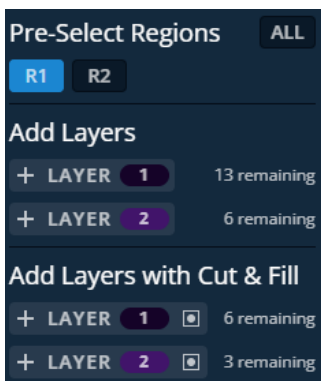

 **Layers quantity**

The number of remaining layers is indicated.

It depends on layers capacity and the use of Cut & Fill .

For more information about using Cut & Fill, see  Cut & Fill effect ^[p.151].

Optimization

Hover over optimization for advice on the best layer allocation.

For more information see  Optimized mode ^[p.65].

Extra

All pending changes are identified with a * and listed in the Summary. If needed, click  to cancel pending changes.



6. Click **Apply** to save new configuration.

A new screen is created and can be further adjusted in Canvas.

6.3.7.3. Create a Screen with no layers

It is possible to create a Screen with no layer (only an unscalable background layer) and display one live input over one or multiple outputs via background sets.

Detailed comparison between Screens with or without layers

See  Screen / Aux Screen comparison ^[p.62].

6.3.8. Create an Aux Screen

Prerequisite

An output must be set to **Aux** mode to be assigned to an Aux Screen.

The Layer quantity is also set in Outputs.



Preconfig > Aux Screens

1. Select an Aux Screen and click Add Output.
2. Select an Aux Output and click Add Output.
3. Click **Apply** to save the new configuration.
4. OPTIONAL: Click on  to remove an Output.

Number of Aux layers

The number of Aux layers depends on the output capacity and the bandwidth of the content used in the layers. For more information, see  Aux Screens and Aux layers ^[p.60].

Extra

All pending changes are identified with a * and listed in the Summary. If needed, click  (on hover) to cancel pending changes.

6.3.9. Rename a Screen

By default, all Screens are named S1, S2, or A1, A2 and so on.



Preconfig > Screens OR Aux Screens

1. Click a Screen or Aux Screen on **Enter Label**.
2. Enter a screen name.

6.4. Preconfig > Canvas

Set:

- pixel space
- outputs settings for each screen (custom rate, position, rotation, AOI, pitch size, blending, etc.).

By default, all output groups are stacked and the screen size is the same as the assigned output group with the highest resolution.

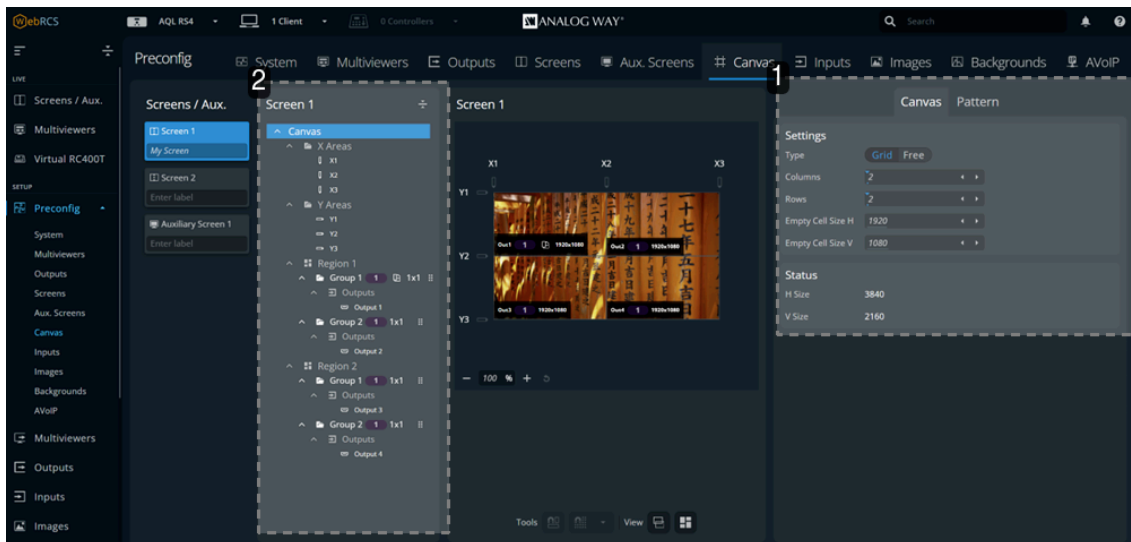

1. Canvas settings

Two types of Screen canvas settings:

Grid type	Recommended for standard shows (a single output screen, a screen with identical displays aligned horizontally or vertically, 2x2, etc.). Covering and gap are simplified in Grid with the X and Y areas.
Free type	Default setting. Recommended for more specific shows that require manual adjustments for each output. Covering is set manually for each output.

Note

Canvas settings are applied to the selected Screen or Group.

Grid and Free type have their own settings and switching between types does not keep the current configuration.

2. Tree view

Select one element to change the corresponding settings in panel (1).

X and Y areas	(Only displayed if the Screen is in Grid type) Create covering or gap between the grid cells Set blending and black areas for covering areas
Groups and DPH104s	Set the position of the output groups (or DPH104) in the Screen canvas Set the format set a format every output in the group (or DPH104) Group Pattern, display patterns to identify the outputs
Outputs	Set the position of the output in the output group Set an AOI for the output

Note

Outputs are placed in groups. And groups are placed in Screens.

An output group fits in one Screen Grid cell. A 2x2 output group fits in a 1x1 Screen Grid.

Tip

In Grid mode, click on  to drag and drop groups and outputs in the cells of the canvas.



: identifies groups which have rotation enabled. The rotation is set in panel (1).

6.4.1. Set output rotation

Output rotation is enabled in Preconfig > Outputs and set in Preconfig > Canvas.

1. In Preconfig > Outputs, select an output group.
2. In Configuration, enable the output **Rotation**, then assign the output to a Screen.
3. In Canvas, select the Screen.
4. In the tree view, select the output group (identified with ).
5. The output group settings are displayed in the right panel.
6. In Rotation, set the rotation angle (**None**, **90°**, **180°** or **270°** counterclockwise).
Output rotation is set for the output group.

Tip

If the physical displays are rotated at 90° clockwise, set the output group rotation at 90°. It is possible to reassign an output to another cell in the virtual canvas.

Note

- Enabling output rotation in Preconfig > Outputs adds a one frame latency.
- Enabling output rotation for a 1x1 output with capacity 2 disables the next output plug.
- When using output rotation on a group, rotation is set individually with each output staying in its position.

2x2 Screen

Display result

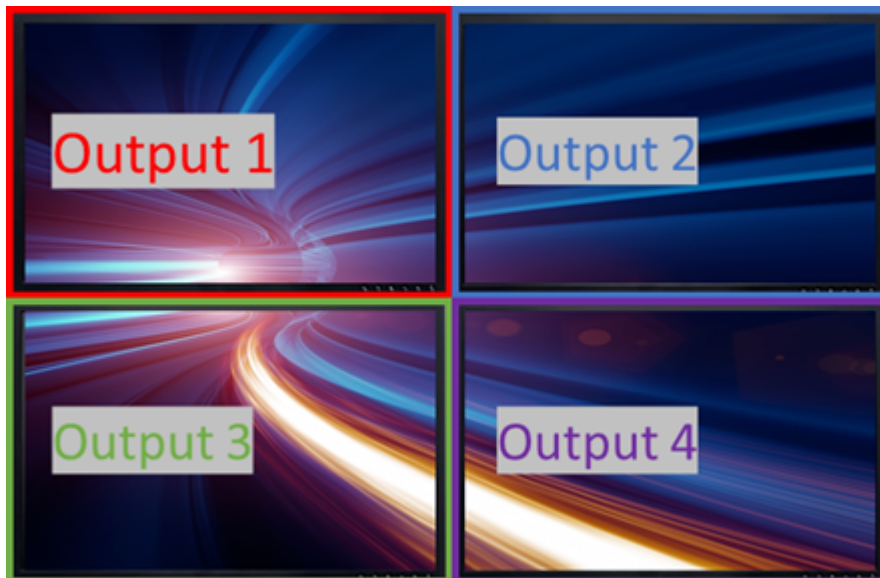

No rotation or 180° rotation



90° rotation CCW or 270° rotation CCW

 3x1 Screen

Display result

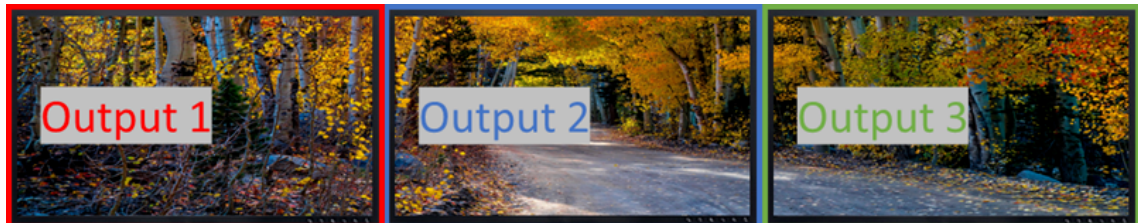

No rotation or 180°



90° or 270°

6.4.2. Patterns

Display patterns are used during the Screen configuration phase to test and control how outputs are displayed in Screens. Use patterns to identify and check if the displays are set correctly (color, position, resolution, etc.).

Screen patterns and Output patterns

It is possible to use Screen patterns and Output patterns.

Screen patterns are displayed on top of Output patterns.

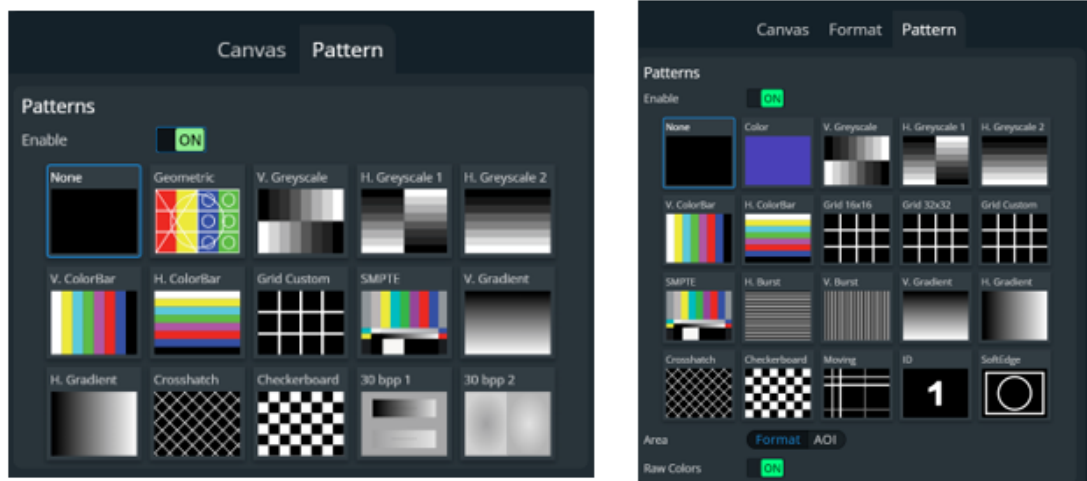

Screen patterns / Output patterns

Note

Enabling a pattern overrides any content displayed in the output.

Make sure to keep all patterns disabled when they are not needed.

6.4.2.1. Screen pattern

Use Screen patterns to apply one pattern on the entire screen.

1. Toggle the enable button to display the pattern in the Screen.
Remember to disable the pattern when not needed.
2. Select the pattern to display.

Customizable patterns

Geometric is fully customizable to adapt to any screen.

Grid Custom, Crosshatch and *Checkerboard* are customizable patterns with units in pixels.

6.4.2.2. Output pattern

Use Output patterns to test and control how outputs are displayed in Screens.

1. Toggle the enable button to display the pattern in the Screen.
Remember to enable and disable patterns on all outputs.
2. Select the pattern to display.
3. OPTIONAL:
 - In Area: Set the pattern to fit the format used or the AOI.
 - Enable raw colors to disable all **Adjustments** settings (ex: Colorimetry, User Gain, etc.).

Raster Box

Click **Format** to enable raster box on whole format.

Click **AOI** to enable raster box on AOI.

Customizable patterns

Grid Custom, Crosshatch and *Checkerboard* are customizable patterns with units in pixels.

6.4.3. Grid canvas

In Grid type, create a grid and assign output groups to corresponding cells to create the Screen canvas.

Tip

An output group fits in one Screen Grid cell. A 2x2 output group fits in a 1x1 Screen Grid.

6.4.3.1. Create a Grid canvas



Preconfig > Canvas

1. Select a Screen.
2. Select the **Grid** canvas type.
3. Enter the number of columns and rows for the Screen Grid.
4. If needed, enter the size for the empty cells of the grid (in pixels).

The canvas is updated with the corresponding values and the total Screen size is indicated.

5. In the Tree view, click an output group and use drag and drop to assign it to a grid cell in the canvas.

OR

Go to **Group Canvas** in the right panel and set its position using the Column and Row settings.

6. In **Group Format**, set a format for every output in the group.

7. In **Group Pattern**, display patterns to identify the outputs.

8. Repeat steps 5 to 7 for all outputs / output groups.

6.4.3.2. Create a covering in Grid canvas (blending)

Edge blending is a feature that gradually fades out the overlapping area from both projectors to create a seamless projection. For an effective blending, align the projected images so they are square with each other.

In Grid type, use X and Y areas to create coverings between outputs.

Note

In Grid type, coverings are equal for all outputs of the same row / column.



Preconfig > Canvas

1. Select a Screen with Grid canvas type.
2. Select the X or Y area where the covering will be created.
3. In **Configuration**, select Covering and enter the size in pixels.

The canvas is updated with the corresponding values.

4. If needed, in **Blending Curve**, enable the blending and set the Gamma or Bezier curve.
5. If needed, set the black area and black levels.

6.4.3.3. Create a gap in Grid canvas (bezel)

In Grid type, use X and Y areas to create gaps between outputs.

Note

In Grid type, gaps are equal for all outputs of the same row / column.



Preconfig > Canvas

1. Select a Screen with Grid canvas type.
2. Select the X or Y area where the gap will be created.
3. In **Configuration**, select Gap and enter the size in pixels.

The canvas is updated with the corresponding values.

6.4.4. Free canvas

Free type is separated in two modes:

- Auto mode to set the position of each output or group freely.
The canvas size is automatically computed and optimized for the created Screen.
- Custom mode to set the Screen size then position each output or group inside the created Screen.

6.4.4.1. Bottom bar buttons – Output position

In Free type, it is possible to use drag and drop in the virtual canvas to position the outputs.

Use the bottom buttons to help positioning outputs in the virtual canvas.

All bottom bar buttons are On/Off Toggle buttons.



Snap to Screen border and other outputs borders



Snap to grid cells. Click the arrow to set the grid (columns and rows).



Hide content to display only layers wireframe



Show Screen regions and layers

6.4.4.2. Create a canvas in Auto mode

Auto mode is recommended for complex shows with unknown canvas size.

In Auto mode, select outputs and enter their H position and V position or use drag and drop to create the Screen canvas.



Preconfig > Canvas

1. Select a Screen.
2. Select the **Free** canvas type and **Auto** size mode.
3. In the tree view, select an output group.
4. Use drag and drop in the canvas to place the output group.

Or

Go to **Group Canvas** in the right panel and enter H and V position for the output group (in pixels).

5. In **Group Format**, set a format for every output in the group.
The canvas is updated with the resolution and position settings.
6. In **Group Pattern**, display patterns to identify the outputs.
7. Repeat steps 3 to 5 for all outputs / output groups.



Tip

Use the tools in the bottom bar to snap to a custom grid and/or other outputs.

6.4.4.3. Create a canvas in Custom mode

Custom mode is recommended for complex shows where the canvas size is known.

In Custom mode, enter a H and V size to create the custom Screen canvas. Then enter position or use drag and drop to position each output inside the canvas.



Preconfig > Canvas

1. Select a Screen.
2. Select the **Free** canvas type and **Custom** size mode.
3. Click **H Size** and **V Size** to enter canvas size.
The canvas size in the virtual screen is updated to match the settings.
4. In the tree view, select an output group.
5. Use drag and drop in the canvas to place the output group.
Or
Go to **Group Canvas** in the right panel and enter H and V position for the output group (in pixels).
6. In **Group Format**, set a format for every output in the group.
The canvas is updated with the resolution and position settings.
7. In **Group Pattern**, display patterns to identify the outputs.
8. Repeat steps 4 to 6 for all outputs / output groups.



Tip

Use the tools in the bottom bar to snap to a custom grid and/or other outputs.

6.4.4.4. Create a covering in Free canvas (blending)

Edge blending is a feature that gradually fades out the overlapping area from both projectors to create a seamless projection. For an effective blending, align the projected images so they are square with each other.



Recommendation

Use manual blending in Free canvas for complex shows only.

For a standard show (ex: 2x2 or 3x1 Screen configuration), use Grid canvas.



Preconfig > Canvas

1. Select a Screen with **Free** canvas type.
2. Select an output where the covering will be created.
3. Go to **Areas** in the right panel and select a side of the output to apply covering.
4. In **Configuration**, enter the covering size in pixels.
The canvas is updated with the corresponding values.
5. If needed, in **Blending Curve**, enable the blending and set the Gamma or Bezier curve.
6. If needed, set the black area and black levels.

7. Repeat steps 2 to 6 for the side(s) of other the output(s).

6.4.4.5. Preview regions and layers in Canvas

After creating the canvas it is possible to show regions and layers to check if the configuration meets the requirements of the show.

Example

See example in  Preconfig - Canvas ^[p.82].



Preconfig > Canvas

1. Select a Screen with multiple regions.
2. In the bottom bar, click  to show the regions and layers.
3. Hover over a layer letter to see the regions where it can be displayed.
4. If needed, return to *Preconfig > Screens* to adjust regions or layer association.

6.4.5. Advanced output settings (in Preconfig > Canvas)

These settings are applied to the selected output(s) and can be used in all canvas types.

6.4.5.1. Canvas settings for DPH104

All DPH104 outputs are limited to a grid created according to the Layout selected in *Preconfig > Screens* (4x1; 2x2 or 1x4).



Preconfig > Canvas

1. Select a Screen.
2. Select a Screen type and place the output groups in the Screen canvas.
3. If needed, set rotation for all the outputs of the DPH104.
4. If needed, change/swap the positions of the DPH104 outputs.

Note

When connecting the DPH104 outputs to multiple video projectors, the LivePremier Web RCS can set outputs overlap. However, blending adjustments must be set using the projectors.

6.4.5.2. Create an area of interest (AOI)

The AOI is a cropped area of the display in the output format. Use AOI to remove unseen or useless display areas and operate exclusively on the output area actually displayed.

The AOI can be set with Overscan size or Custom size.



Preconfig > Canvas

1. Select a Screen.
2. Select an output.
3. In AOI, click **Overscan** and set the overscan.

Or

Click **Custom** and set the size and position of the AOI.**Tip**

Use arrows for fine adjustment.

6.4.5.3. Pitch compensation

Some Screens using multiple outputs can have outputs with different pitches, especially LED video walls. Using pitch compensation corrects the outputs with different pitches for a screen with homogeneous scaling.



Preconfig > Canvas

1. Select a Screen.
2. Select an output group to set a different pitch.
The reference output group should use a 1:1 pitch.
3. In Pitch, set the H and V ratio of the output group compared to the reference output group.

6.5. Preconfig > Inputs

Set:

- input group
- input format
- input visibility.

6.5.1. Input group

Input group

Grouping inputs optimizes the processing resources of the VPU and saves layers in Screens. It allows more inputs in the same VPU.

It is possible to group up to four inputs together (ex. four 1920x1080 inputs can be used as one 3840x2160 source for a 4K output).

**Not supported for NDI inputs.*

How it works

- An input can only be grouped with the following input in the same input card.
- It is possible to group four live inputs.
- The group leader is always the input with the lowest number (ex: If input 7 and 8 are grouped together, then input 7 is the leader and input 8 is set as *Grouped*).
- Input settings available in the input menu are common for all inputs in the group (color space, patterns, crop, keying, etc.).

Note

- When grouped together, every input must have the same format and the group bandwidth is limited to capacity 2 (total pixel space is limited to 4096x2160).
- If the Internal rate is set above 60Hz, input resolutions beyond 2560x1600 will not be supported no matter the frame rate.

Input group examples

Group four live inputs (in 1x4, 2x2 or 4x1) and use them as one source in one layer.

Or

Set a quad HDTV live input as background content for a 4K output group.

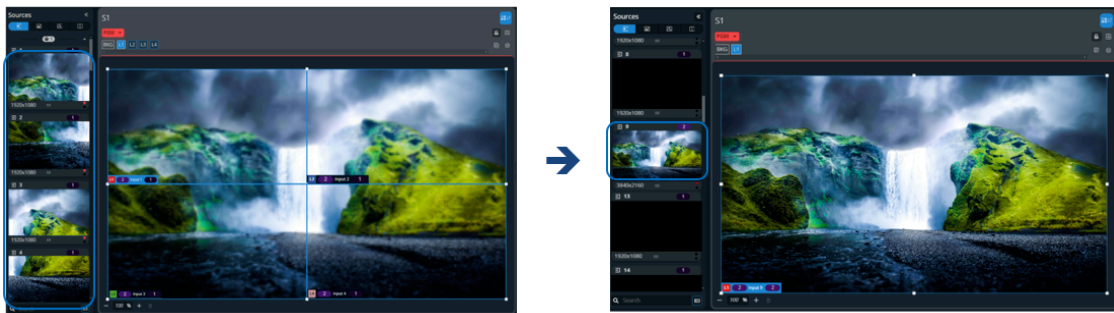

Four HD inputs used as one 4K input source

6.5.2. Set an input group



Preconfig > Inputs

1. Select one or more inputs.
2. In **Configuration**, select the input group layout (**1x1** by default).
Selecting a higher group layout automatically groups the following input(s).
3. In **Expected Signal**, set the format applied to every input of the group.

Or

Click  to automatically fit to the detected signal.

The capacity is indicated for this input group.

Capacities

- An input group with capacity 2 can only be displayed in a layer with capacity 2.
- An input group with capacity 2 uses 2 Aux layers (one layer will be preempted).

6.5.3. Set four 3G-SDI inputs for 2SI format

Tip

It is possible to connect four 3G-SDI inputs in any order as long as they are connected to the same input card and the SDI signal is encoded in 2SI format.

1. Connect the four 3G-SDI on the same input connector card on the rear panel.
2. In Preconfig > Inputs, select the first SDI input of the group.
3. In **Configuration**, set the group layout to **2x2**.
4. In **Expected Signal**, set the format applied to every input of the group.

The content is automatically recomposed by the LivePremier device and the content is ready to be used as a single 4K source.

6.5.4. Set an NDI input

The IP/SDI input card can accommodate up to 4 full bandwidth NDI streams in parallel, or 4 12G-SDI sources, or any combination of the two.

Note

The NDI inputs cannot be grouped. The only possible configuration is 1x1.

1. Connect an RJ45 cable and, if needed, a required number of 12G-SDI sources on the same input connector card on the rear panel.
2. In Preconfig > Inputs, select an IP/SDI input.
3. In **Configuration**, select an NDI plug (or SDI for 12G-SDI).
4. In **Expected Signal**, set the format applied to every input.
5. Click **Apply**.

The input connector is modified according to the selected plug type.

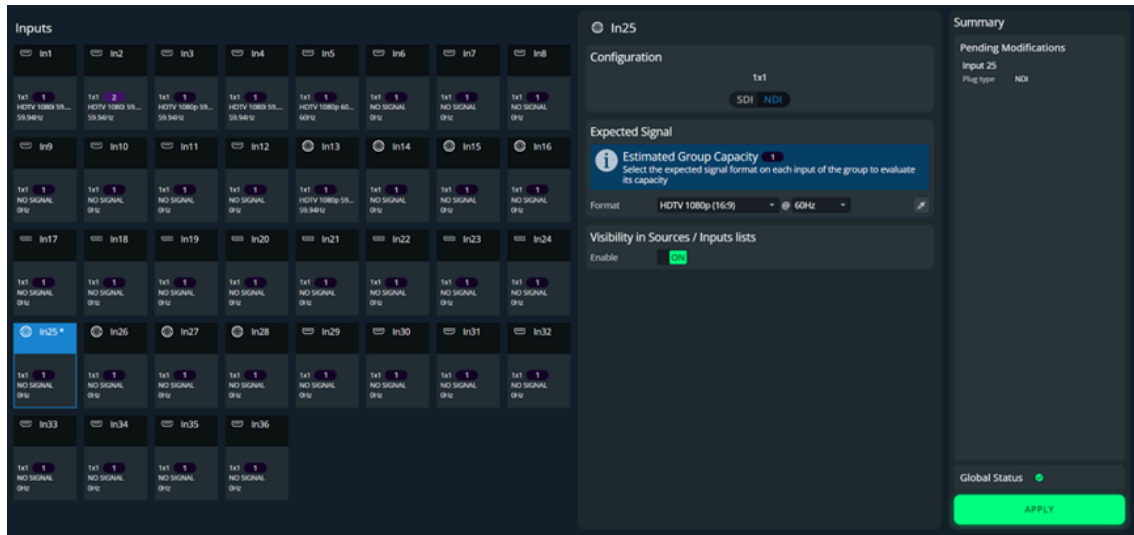

NDI and SDI inputs on IP/SDI card

6.5.5. Set an input visibility



Preconfig > Inputs

1. Select one or more inputs.
2. In **Configuration**, enable / disable the input(s) visibility in Sources and Inputs lists.

6.6. Preconfig > Images

Set:

- the expected image resolution for image slots
- image visibility.

6.6.1. Image slots

The number of available image slots displayed at the same time depends on the number of IPU of the unit and the image slots capacity.

Number of IPUs	Image slots available
1	24 image slots at capacity 1
	12 image slots at capacity 2
2	48 image slots at capacity 1
	24 image slots at capacity 2

Image slots capacities

Image slots of capacity 1 and 2 can be displayed at the same time.

An image slot with capacity 2 uses the resources of the next slot and preempts it, no matter the real image resolution.

An image slot with capacity 2 can only be displayed in a layer with capacity 2.

An image slot with capacity 2 uses 2 Aux layers (one layer will be preempted).

More information on IPU

See  IPU^s [p.67].

6.6.2. Set images preset capacity



Preconfig > Images

1. Select one or more image slots.
2. In the right panel, set the expected image resolution for the image slot(s).
The capacity is indicated for this image slot.
The slot capacity stays the same when changing the image in the slot.

Note

If the Internal rate is set above 60Hz, some image resolutions may not be supported.

6.6.3. Set images visibility



Preconfig > Images

1. Select one or more image slots.
2. In the right panel, enable / disable the image(s) visibility in Sources and Images lists.

6.7. Preconfig > Backgrounds

Create background sets for each Screen.

Up to eight Background sets can be saved per screen.

6.7.1. Background sets

Each Screen is composed of one or more output groups. Assign inputs and images to these output groups to create background sets.

Background sets can only be used in Screens.

Note

- One input can be set as a background source for multiple output groups if they have the same format.
- Aux Screens use a custom monochrome color as background (set in the layer properties in Live – Screens / Aux Screens).

6.7.2. Background set for a Screen with one output group

Important

The content and output capacities must match.

Otherwise, it is not possible to assign it to the background set.

The procedure is the same for one output and for one output group with multiple outputs.

Example

Screen 1 is a single output screen using Output 1.

1. Select **BS1** in **Screen 1**.
2. Click a source icon to open the Inputs or Images sources.
3. Click  in the top right corner of background canvas to display the Output capacity and resolution and add content from the dropdown list.

Or

Drag a content and drop it directly in the virtual canvas.

Background set 1 is set and saved.

Repeat the procedure with BS2, BS3, etc. to create more Background Sets for Screen 1.

6.7.3. Background set for a Screen with multiple output groups

Important

The content and output capacities must match.

Otherwise, it is not possible to assign it to the background set.

Example

Screen 2 is a 4x1 screen using Outputs 3, 4, 5 and 6, each output is a 1x1 output group.

1. Select **BS1** in **Screen 2**.
2. Click a source icon to open the Inputs or Images sources.
3. Click  in the top right corner of background canvas to display all the Screen Outputs, their capacity and resolution and add content from the dropdown list.

Or

Drag a content and drop it directly in the virtual canvas of Output 3.

4. Repeat for other outputs.

Background set 1 is set and saved.

Repeat the procedure with BS2, BS3, etc. to create more Background Sets for Screen 2.

6.7.4. Reset a background set



Preconfig > Backgrounds

1. Select a Background Set.
2. Hover over the top right corner of the virtual canvas and click  to clear the background set.

Option

Select each output and press the **Del** key to remove the assigned content one by one.

6.7.5. Remove a source from all background sets



Preconfig > Backgrounds

1. Click  in the top right corner of a source content.
2. Click **Remove from all BKG Sets**.

6.8. Preconfig > AVoIP

- Click on an input / output connector to display status information of a corresponding AV over IP device (IP/SDI, SDVoE or Dante).
- Modify selected settings.

6.8.1. IP/SDI

IP/SDI input card can accommodate up to four NDI full bandwidth streams.

Any unused NDI input may be changed to an SDI input by modifying a plug type in Preconfig > Inputs.



Recommendation

- Use TCP protocol for NDI encoder for optimum performance.
- Limit UDP protocol use to multicast only.



How it works

Click on an IP/SDI card connector to display the corresponding NDI properties and:

- Define the IP/SDI card network.
- Find NDI sources.
- Assign a source to a selected input and set a video buffer size.

6.8.1.1. Define IP/SDI card network



1. Enter the **Host Name** in the **NDI** menu.
2. In **Network** tab below, enable DHCP to automatically define the IP address of the IP/SDI input card or manually enter the network information and click **Apply**.

6.8.1.2. Find NDI sources

The mDNS service is enabled by default and allows to automatically find the available streams.

In **NDI Sources** tab in the right panel, click on  under **Detected Sources** to display a list of streams.

To display more sources:



- Enable Discovery Server (if present) and enter its IP address. Click on  to update the list of detected sources.
- Enable Static IP list and enter the IP address of a streaming device. Click on  to update the list of detected sources.

IP addresses

- Click on **Add Server IP** to enter up to 100 static IP addresses per IP/DSI input card.
- Use **On/Off** button to activate them as need or  to remove them.

6.8.1.3. Assign a source to an input

If an NDI source is currently assigned to an input, a colored LED in front of an input on the interactive rear panel indicates the stream status:

-  Stream correctly decoded in progress
-  Decoding speed degradation
-  Decoding error

Tip

Open the **Input** tab in the **NDI** menu to see the details of decoding error.

To assign a source to input:

1. Select an input on the interactive rear panel.
The selected input is highlighted.
2. In the **Input** tab on the right panel, select a source from a drop-down list.
3. In the **NDI** menu above, check the real time load indications of the IP/SDI card (CPU, Network; GPU, FPGA) to determine the size of the buffer necessary to maintain a proper audio/video synchronization.
4. Enter the buffer size.

 **Load indicator**

- A load indicator at 100 % indicates an overload. Please check the ACC-AQL-IN-IP-SDI Datasheet for the recommended NDI decoding performance.
- If the NDI stream does not include audio channels, the buffer can be set to 0. Increasing the buffer size may be necessary in case of unstable network connection to prevent audio pops or audio/video desynchronization problems.

6.8.2. SDVoE

Click on an SDVoE input / output card connector to display the SVDoe properties and check the card status and network.

6.8.3. Dante

LivePremier can manage Dante routing for up to 64 input channels and 64 output channels at 48 kHz.

Click on Dante connector to display the status of the card (serial number, module, version, etc.) and:

- Click Reboot to restart the Dante card.
- Click Factory Reset to reset the firmware of the Dante card.
- Click on the tabs below to display network information and the current routing (Channels Receivers and Channels Transmitters).

 **Dante update**

The update of the Dante card is integrated in the firmware update of the LivePremier unit. A pre-requisite is to install AW Dante Firmware v3.7.0.X (available on Analog Way's website) using the Dante Firmware Update Manager tool before updating the LivePremier firmware.

7. Multiviewers

In  Multiviewers, set:

- Label
- Format
- Signal parameters
- Image correction
- Patterns.

More options

- Go to Preconfig > Multiviewers to enable One Multiviewer or Two Multiviewers screens.
- Go to Live > Multiviewers to set the Multiviewers layout and Widgets.

7.1. Multiviewers settings

Click a Multiviewer output to open its settings. The selected output is highlighted in the interactive rear panel.

Options

- Enter the label to rename the Multiviewer.
- On the interactive rear panel, hover over an output connector to display information about this output.
- On the interactive rear panel, click an output to open its settings.
- Click  to capture the video signal into an image file.

7.2. Multiviewers format

In  Multiviewers, select an output and adjust the settings:

Setting name	Description / Setting selection
Mode	Set to follow internal rate or select a custom rate in the list
Format	Set the format for the Multiviewer display

7.3. Multiviewers signal

In  Multiviewers, select one Multiviewer.

In **Signal**, adjust the following settings:

Setting name	Description / Setting selection
Pixel Encoding	Auto or RGB Full (8 or 10 bits), RGB Limited (8 or 10 bits), YCbCr 4:4:4 (8 or 10 bits), YcbCr 4:2:2 (12 bits), or YcbCr 4:2:0 (8 or 10 bits)
Color Space	Auto, ITU-R BT.709, or ITU-R BT.2020
DVI mode	Enable to change HDMI signal into DVI signal if using a DVI connector on the Multiviewer display
DDC Bus Speed	Slow, Medium or Fast (HDMI only)
HDCP	Disable*; Auto; HDCP 1.x; or HDCP 2.x

* Disabling HDCP reduces potential problems when the content is not fully HDCP compliant. When output HDCP is disabled, HDCP-protected inputs are not displayed.

Recommendation

Always use high quality cables to prevent connection and bandwidth errors when using HDCP.

Good to know

- The actual Pixel encoding and Color space used can be different from the one set in the output format. It is indicated in the details of the signal status in the table.
- DDC Bus Speed is set to **Fast** by default. Using **Slow** or **Medium** speed can be needed to resolve compatibility issues when using HDMI over fiber extenders.

7.4. Multiviewers adjustment (image correction)

In  Multiviewers, select one Multiviewer.

In **Adjustments**, change the following settings:

Setting name	Description / Setting selection
Brightness	Adjust Global, Red, Green and Blue for Brightness (Global and RGB are cumulative)
Contrast	Adjust Global, Red, Green and Blue for Contrast (Global and RGB are cumulative)
Colorimetry	Adjust Saturation and Hue
Temperature	Adjust Temperature
Gamma	Adjust Gamma level

7.5. Multiviewers pattern

In  Multiviewers, select one Multiviewer.

In **Pattern**, change the following settings:

Setting name	Description / Setting selection
Patterns	
Enable	On/Off toggle. Display the pattern in Multiviewer
Patterns	Select the pattern to display
Area	Set the pattern to fit the format used or the AOI
Raw Colors	On/Off toggle. Using raw colors disables all Adjustments settings (ex: Colorimetry, User Gain, etc.)
Raster Box	
Format	Click to enable raster box on whole format
AOI	Click to enable raster box on AOI

 **More information on pattern types**

See  Patterns ^[p.86].

8. Outputs

In  Outputs, set for each output group:

- Label
- Format
- Signal parameters
- Image correction
- Patterns.

Output preview

The thumbnail preview is only possible for outputs used in Screens.
Outputs used in Aux. Screens have a black thumbnail.

More options

Go to Preconfig > Outputs to set output resources.

8.1. Outputs main screen

Go to  Outputs

The outputs main screen displays all outputs in a Grid view.

The following information are displayed per output:



1. Format, rate and resolution
2. Output capacity
3. Output number and label
4. Screen number using that output

8.2. Output settings

In  Outputs, click an output to open its settings.

The selected output is highlighted in the interactive rear panel and all output information is listed next to the Output preview.



Options

- Click **All** to return to the outputs Grid.
- Enter the label to rename the selected output.
- On the interactive rear panel, hover over an output connector to display information about this output.
- On the interactive rear panel, click an output to open its settings.

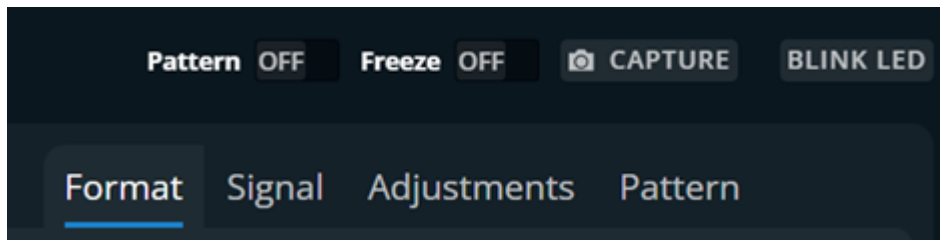
Settings panel



Output settings

- Toggle **Pattern** to replace the content with a pattern (see  Output pattern ^[p.108]).
- Toggle **Freeze** to pause the content of this output group.
- Click  to capture the Program output video signal into an image file.
- Click **Blink LED** to identify the selected output connector on the physical rear panel of the unit.

8.2.1. Output format

In  Outputs, select an output and adjust the settings.

Output format settings are identical for all outputs of the same group.

Setting name	Description / Setting selection
Mode	Set to follow internal rate or select a custom rate in the list
Format	Set the format for each output of the group
Configuration (only with DPH104)	<p>OSD ON/Off toggle: Display / hide On Screen Display DPH104 information</p> <p>Audio:</p> <ul style="list-style-type: none"> Select Mirror to send all 8 audio channels on all outputs Select Split to send audio channels 1&2 to DPH104 Output 1, audio channels 3&4 to DPH104 Output 2, and so on
Phase Shift	<p>Set Horizontal and Vertical offsets for each output of the group</p> <p>: indicates that an output group has a phase shift set.</p>

8.2.2. Output signal

In  Outputs, select an output.

In **Signal**, depending on Internal Profile, adjust the following settings:

Setting name	Description / Setting selection
Settings	
Pixel Encoding	Auto or RGB Full (8 or 10 bits), RGB Limited (8 or 10 bits), YcbCr 4:4:4 (8 or 10 bits), YcbCr 4:2:2 (12 bits), or YcbCr 4:2:0 (8 or 10 bits)
Color Space	Auto, ITU-R BT.709, or ITU-R BT.2020
Dynamic Range	Auto, SDR, HDR10 or HLG
Luminance	Select the nit level used for this output
SDI Mapping	Auto, Quad Link Four Quadrants or Quad Link 2SI (SDI 2x2 group only)
SDI 3G Standard	Level A or Level B (SDI output only)
HDCP	Disable*, Auto, HDCP 1.x, or HDCP 2.x
DVI mode	Enable to change signal into DVI signal if using a DVI connector on the display
DDC Bus Speed	Slow, Medium or Fast (HDMI only)
HDMI/DP/SDI Interface	Reset the output interface to restore the connection

* Disabling HDCP reduces potential problems when the content is not fully HDCP compliant. When output HDCP is disabled, HDCP-protected inputs are not displayed. Please note that for SDVoE connectors, the HDCP status must be specified on the network, using the external SDVoE controller.

More information on dynamic range settings

see *LivePremier LUT Architecture* application note available on www.analogway.com [http://www.analogway.com/].

Recommendation

Always use high quality cables to prevent connection and bandwidth errors when using HDCP.

Good to know

- The actual Pixel encoding and Color space used can be different from the one set in the output format. It is indicated in the details of the signal status in the table.
- DDC Bus Speed is set to **Fast** by default. Using **Slow** or **Medium** speed can be needed to resolve compatibility issues when using HDMI over fiber extenders.

Setting name	Description / Setting selection
Conversion Mode	
Mode	Auto or LUT
Conversion LUT	In LUT Conversion mode, select a LUT from the Conversion LUT library
Mapping	For SDR with HLG as internal profile only <ul style="list-style-type: none"> • Inverse Tone Mapping: use if if internal processing and main input are using Limited Range color space • Direct Mapping
Reference	For HLG ↔ SDR conversion only <ul style="list-style-type: none"> • Scene Referred: for camera content • Display Referred: for computer content
OETF	For Scene Referred only: Square Root or Strict

Importing a LUT in the library

See  Importing a LUT [p.131].

8.2.3. Output adjustment (manual image correction)

In  Outputs, select an output.

In **Adjustments**, in **Manual** correction mode, change the following settings:

Setting name	Description / Setting selection
Brightness	Adjust Global, Red, Green and Blue for Brightness (Global and RGB are cumulative)
Contrast	Adjust Global, Red, Green and Blue for Contrast (Global and RGB are cumulative)
Colorimetry	Adjust Saturation and Hue
Temperature	Adjust Temperature
Gamma	Adjust Gamma level

8.2.4. Output adjustment using Correction LUT

In  Outputs, select an output.

1. In **Adjustments**, select **LUT** correction mode.
2. In **Correction LUT**, select a LUT from the Correction LUT library.
The Correction LUT is applied to the corresponding output group.

Importing a LUT in the library

See  Importing a LUT ^[p.131].

8.2.5. Output pattern

In  Outputs, select an output.

In **Group Pattern**, change the following settings:

Setting name	Description / Setting selection
Patterns	
Enable	On/Off toggle. Display the pattern in all outputs of the group
Patterns	Select the pattern to display
Area	Set the pattern to fit the format used or the AOI
Raw Colors	On/Off toggle. Using raw colors disables all Adjustments settings (ex: Colorimetry, User Gain, etc.)
Raster Box	
Format	Click to enable raster box on whole format
AOI	Click to enable raster box on AOI



More information on pattern types

See [Patterns](#)^[p.86].

9. Inputs

In  Inputs, set:

- Label
- Signal parameters
- Aspect
- Keying
- Image correction
- Patterns
- NDI source (for NDI plugs only).

Note

Input settings are identical for all inputs of the same group.

More options

Go to Preconfig > Inputs to set Input resources.

9.1. Inputs main screen

Go to  Inputs

The inputs main screen displays all inputs in a Grid view.

The following information are displayed per input:

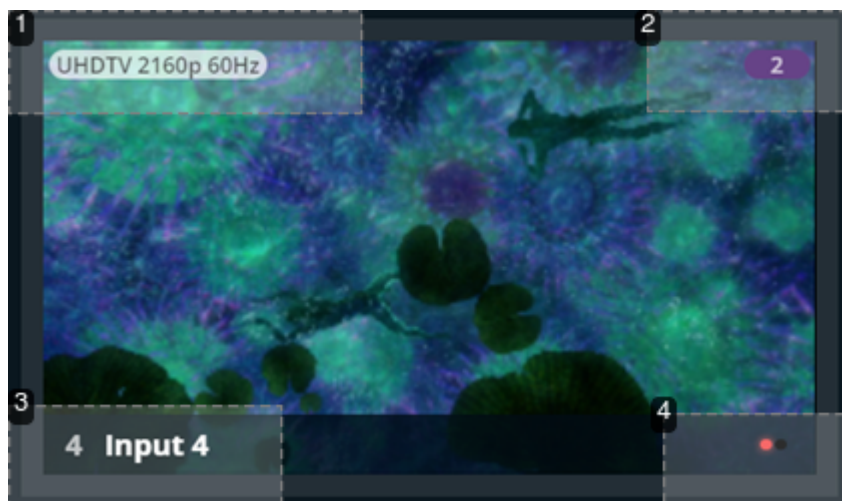

1. Format, rate and resolution
2. Input capacity
3. Input number and label

4. The tallies

The tallies turn red and green if the input is used in a ● **Program** and/or ● **Preview** Screen.

9.2. Input settings

In  Inputs, click an input to open its settings.

The selected input is highlighted in the interactive rear panel and all input information is listed next to the Input preview.



Options

- Click **All** to return to the Inputs Grid.
- Enter the label to rename the selected input.
- On the interactive rear panel, hover over an input connector to display information about this input.
- On the interactive rear panel, click an input to open its settings.

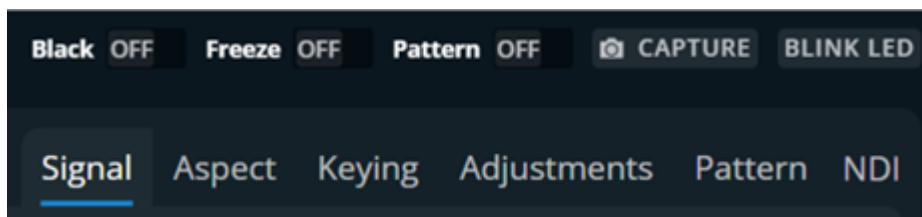
Settings panel



Input settings

- Toggle **Black** to display a black image in all layers using this input.
- Toggle **Freeze** to pause the content in all layers using this input (this does not pause the playback of a media).
- Toggle **Pattern** to replace the content with a pattern (see  Input pattern ^[p.116]).
- Click  to capture the input video signal into an image file.
- Click **Blink LED** to identify the selected input connector on the physical rear panel of the unit.

9.2.1. Input signal

In  Inputs, select an input.

In **Signal**, depending on Internal Profile, adjust the following settings:

Setting name	Description / Setting selection
Settings	
Signal Type	Auto, YUV, RGB Full (0-255) or RGB Limited (16-235)
Dynamic Range	Auto, SDR, HDR10 or HLG

Luminance	Select the nit level used for this input
SDI Mapping	Auto, Quad Link Four Quadrants or Quad Link 2SI (SDI 2x2 group only)
HDCP	None*, Default, HDCP 1.x Only or HDCP 1.x and 2.x
HDMI/DP/SDI Interface	Reset the output interface to restore the connection
Conversion Mode	
Mode	Auto or LUT
Conversion LUT	In LUT Conversion mode, select a LUT from the Conversion LUT library
Mapping	For SDR with HLG as internal profile only <ul style="list-style-type: none"> • Inverse Tone Mapping: use if if internal processing and main input are using Limited Range color space • Direct Mapping
Reference	For HLG ↔ SDR conversion only <ul style="list-style-type: none"> • Scene Referred: for camera content • Display Referred: for computer content
OETF	Square Root or Strict

* Disabling HDCP reduces potential problems when the content is not fully HDCP compliant. When input HDCP is disabled, HDCP-protected inputs are not displayed. Please note that for SDVoE connectors, the HDCP status must be specified on the network, using the external SDVoE controller.

More information on dynamic range settings

See *LivePremier LUT Architecture* application note available on www.analogway.com [http://www.analogway.com/].

Recommendation

Always use high quality cables to prevent connection and bandwidth errors when using HDCP.

Importing a LUT in the library

See  Importing a LUT [p.131].

9.2.2. Input aspect

In  Inputs, select an input.

In **Aspect**, set the Aspect ratio or set input crop.

 **Important**

Aspect ratio and Crop replaces the input content and affects every layer using it. If needed, use crop at layer level in Live or duplicate the input with a splitter.

9.2.2.1. Set input aspect ratio

Change the input aspect ratio in all layers. Use these settings to correct the input aspect ratio if needed.

Setting name	Description / Setting selection
Aspect Ratio	
Content ratio	Force an aspect ratio for the input if it needs correction (non-square pixels) Native; 5:4; 4:3; 16:10; 15:9; 16:9; 21:9 or 64:27
Transform to	Set the final aspect ratio for the input. This is the aspect ratio used for the Layer fill option. Native; 5:4; 4:3; 16:10; 15:9; 16:9; 21:9 or 64:27
Layer fill option	1:1; Centered; Fullscreen or Cropped

 **Option**

To keep the input unchanged, modify aspect ratio at layer level.

9.2.2.2. Set input crop

Crop input (ex: black bars) and keep only wanted area in layers.

Setting name	Description / Setting selection
Crop	
Finder	On/Off toggle. Display cropping area in output, use during setup and disable Finder to show the crop result output.
Top, Bottom, Left, Right	Enter cropping values (in pixels)

 **Note**

Input crop affects the whole group. Input crop is not possible for individual inputs inside a group.

9.2.3. Input keying

In  Inputs, select an input.

In **Keying**, key the content using Chroma Keying, Luma Keying, CremaTTe 3D LUT or Cut & Fill.

Input keying applies to all inputs in the same input group.

Options

- Use Chroma Keying to key a color (or hue).
- Use Luma Keying to key a Luma level (or brightness).
- Use CremaTTe 3D LUTs for advanced keying with dedicated AW tool (*Not available for 8-plug HDMI input card*).
- Use Cut & Fill to key an input without losing extra layers.

Free AW tool

AW CremaTTe 3D is a free tool used to create a keying LUT using the inputs of a LivePremier. It is available on www.analogway.com [<http://www.analogway.com/>].

9.2.3.1. Set Chroma Keying

In  Inputs, select an input.

1. Click Keying and **Chroma** mode.
2. Enable Freeze on the content.
3. In Value, select the Hue to Key (color).
4. Or use the assistant to pick directly from the content:
 - a. Enable the assistant.
 - b. Select the area to pick in the preview.
 - c. Click **Pick** to get the Hue value from the content.
 - d. Disable the assistant.
5. Enable the **Color** mask.
The content becomes blue, gray and red.
6. In Tolerance, adjust the settings until the Keying is correct:
 - The preserved content is displayed **blue**.
 - The keyed content is displayed **red**.
7. In Colorimetry, adjust the Color Correction to fade the selected hue.
8. Enable / Disable Freeze and Color mask to view the keying result and adjust settings until satisfied

Option

The **Black and White** mask is similar with the preserved content displayed in white and the keyed content in black.

9.2.3.2. Set Luma Keying

In  Inputs, select an input.

1. Click Keying and **Luma** mode.
2. Enable Freeze on the content.
3. In Value, select the Luma to Key (Brightness level).

4. Or use the assistant to pick directly from the content:
 - a. Enable the assistant.
 - b. Select the area to pick in the preview.
 - c. Click **Pick** to get the Luma value from the content.
 - d. Disable the assistant.
5. Enable the **Color** mask.
The content becomes blue, gray and red.
6. In Tolerance, adjust the settings until the Keying is correct:
 - The preserved content is displayed **blue**.
 - The keyed content is displayed **red**.
7. Enable / Disable Freeze and Color mask to view the keying result and adjust settings until satisfied

Option

The **Black and White** mask is similar with the preserved content displayed in white and the keyed content in black.

9.2.3.3. Keying using a CremaTTe 3D LUT from the Library

In  Inputs, select an input.

1. Click Keying and **CremaTTe 3D** mode.
The input's color space must be the same as the color space set for processing in system pre-configuration.
2. Enable Freeze on the content.
3. In CremaTTe 3D LUT, select a LUT from the CremaTTe 3D LUT library.
The LUT is used for the keying of the input group.
4. Enable / Disable Freeze and Color mask to view the keying result.

Importing a LUT in the library

See  Importing a LUT ^[p.131].

9.2.3.4. Set Cut & Fill

In  Inputs, select an input.

1. Click Keying and **Cut & Fill** mode.
2. Select the cut content from the dropdown list.
The cut content must have the same format and capacity as the fill input and come from the same input card.
3. If needed, use the Curve setting to adjust the transparency level of the Cut & Fill.
4. If needed, enable the Black and White or the Color mask to ease the setting operations.

9.2.4. Input adjustment (manual image correction)

In  Inputs, select an input.

In **Adjustments**, in Manual mode, modify the following settings:

Setting name	Description / Setting selection
Brightness	Adjust Global, Red, Green and Blue for Brightness (Global and RGB are cumulative)
Contrast	Adjust Global, Red, Green and Blue for Contrast (Global and RGB are cumulative)
Colorimetry	Adjust Saturation and Hue
Sharpness	Low, Medium or High

9.2.5. Input adjustment using LUT Correction

Not available for 8-plug HDMI input card.

In  Inputs, select an input.

1. In **Adjustments**, select LUT correction mode.
2. In **Correction LUT**, select a LUT from the Correction LUT library.
The Correction LUT is applied to the corresponding input group.

Importing a LUT in the library

See  Importing a LUT ^[p.131].

9.2.6. Input pattern

When enabled, a pattern overrides any input signal. Most patterns offer adjustment to isolate a particular color for easier troubleshooting and calibration.

Important

A pattern applies to all inputs in the same input group.

In  Inputs, select an input.

In **Pattern**, change the following settings:

Setting name	Description / Setting selection
Patterns	
Enable	On/Off toggle. Display the pattern in input.
Patterns	Select the pattern to display.

 **More information on pattern types**

See  Patterns ^[p.86].

9.2.7. Input NDI source

In  Inputs, select an input.

1. Click on **NDI** tab in right panel.
2. Click on  to update the list of detected sources.
3. Select a source from a drop-down list.
4. Enter or modify the existing buffer according to the real time NDI status (CPU, GPU, FPGA and network load).

 **Tip**

NDI sources cannot be changed automatically by a preset call. To quickly change an NDI source, click on  in any NDI input thumbnail to update the list of NDI sources, select a new stream and if necessary, adjust the buffer size.

10. Images and Library

Image management is separated in two menus:



Image Library: to transfer images to the LivePremier unit.



Images: to assign uploaded images to image slots to be used in layers.

10.1. Library

LivePremier units can store up to 200 images, within 950 MB limit.

Image Library

54.34 MB / 950.00 MB



Go to Image Library.

All imported images are displayed in a Grid view.

The following information are displayed per image:

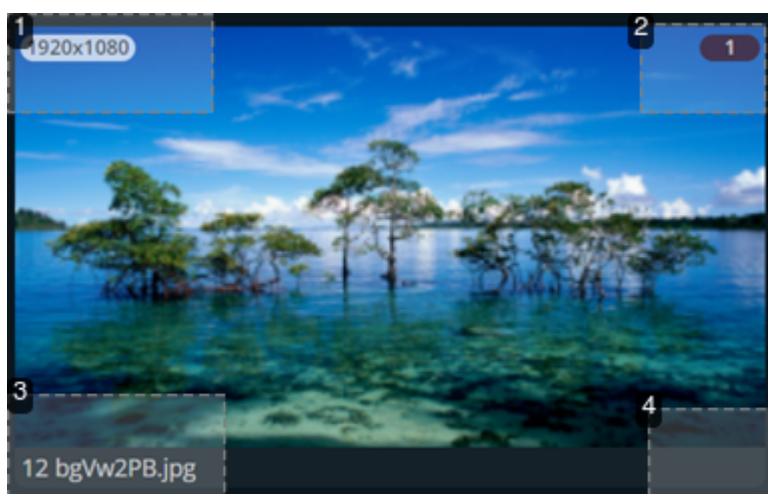

1. Resolution
2. Image recommended capacity
3. Image number (in Library) and Image file name
4. Options available on hover:



Download to PC



Upload from PC



Delete from library

10.1.1. Image formats

LivePremier units support the following image formats:

BMP GIF* JPG PNG TIF

* not animated

Animated images (ex: animated GIF) are not supported

10.1.2. Image specifications

- Maximum width: 16 384 pixels
- Maximum height: 8 192 pixels
- Maximum width x height: 8 847 360 pixels (= 4096x2160)
- Maximum file size: 35 MB

Note

Images cannot be resized or renamed in the Library. If needed, download the image, modify it and then re-upload it.

10.1.3. Transfer images from the computer to the unit

1. Select one or multiple image files (or a folder) on the computer file browser.

Only one folder can be imported at a time.

2. Drag and drop the selection in the **Drop images or folder of images** block in Image Library .

Or

Click the **Drop images or folder of images** block in Image Library  to open the file explorer and select image file(s) to transfer.

3. Click **Upload Images**

The selected images are imported into the Library and can be loaded into image slots in Images .

10.1.4. Capture a video signal into an image file

In Image Library:

Procedure

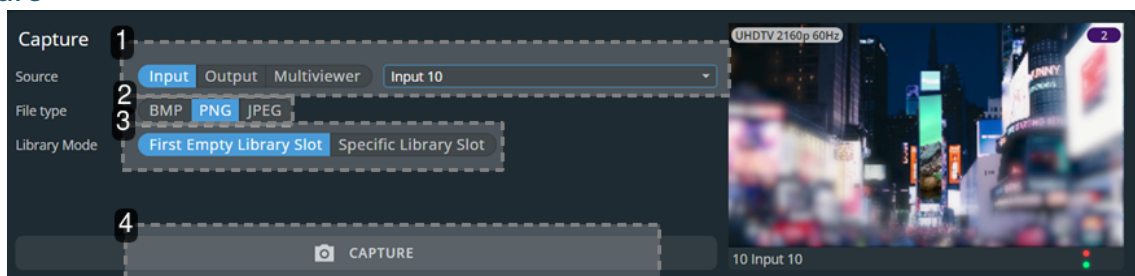

1. Select the source to capture.
2. Select the image format for the capture.
3. Select a slot to save the capture.
4. Click to capture the video signal into an image file.

The image is created in the Library and can be loaded into image slots in Images .

Option

Image capture is also possible directly from the *Live, Multiviewers, Outputs and Inputs* pages.

Procedure

1. Click on  **Capture**.

The image is created in the Library and can be loaded into image slots.

10.1.5. Download an image file from the unit

In  Image Library

- Hover over an image then click .

The selected image is downloaded to the computer.

10.1.6. Upload an image file to the unit

In  Image Library

- Hover over a slot then click .

Or

- Drag and drop an image directly to a slot.

The selected image is uploaded to the unit

10.1.7. Delete an image file from the unit

In  Image Library

- Hover over an image then click .

The selected image is deleted from the Library.

10.1.8. Manage Image Library from the front panel

It is also possible to manage Library images from the front panel in the **Export** menu:

- Download images from a USB drive to the Library (one at a time).
- Download images from the Library to a USB drive (one at a time).
- Delete one or all images from the Library.

Option

Export and Import the entire Library by exporting the Device configuration and filtering only Images.

10.2. Images

LivePremier units can have up to 48 image slots.

Up to 48 images can be displayed simultaneously in layers.

10.2.1. Images main screen

Go to  Images

All images presets are displayed in a Grid view.

The following information is displayed per image slot:



1. Resolution
2. Image slot capacity
3. Image slot number and image slot label
4. The tallies

The tallies turn red and green if the input is used in a  **Program** and/or  **Preview** Screen.

More options

Image slots capacities are set in Preconfig > Images.

10.2.2. Image slots settings

In  Images, click an image slot to open its settings.

The selected image slot is highlighted in the interactive slot grid and all image slot information is listed next to the image slot preview.

Options

- Click **All** to return to the image slot Grid.
- In the header, rename the selected image slot.
- On the interactive slot grid, hover over an image slot to display the image slot preview.
- On the interactive slot grid, click an image slot to open its settings.

10.2.3. Downscale to capacity

When an image resolution is higher than the image slot capacity, the unit can either resize the image to fit the capacity or display nothing.

This option named **Allow downscale** is available for each image slot.

10.2.4. Assign an imported image to an image slot

In  Images, click an image slot to open its settings.

Use the arrows to browse through the image slots.

1. In Identification > Label, enter a label to rename the Image slot.
2. In Option, enable **Allow downscale** to resize the image when the image slot capacity is too low for the image resolution.
3. In Display, select an image from the Library to be used in this image slot.

The selected image is now loaded to an image slot and is ready to be displayed in layers.

10.2.5. Assign a timer to an image slot

Timers can be assigned to image slots. They can then be used in layers just like regular images.

Tip

Timers can be displayed in Multiviewers without being assigned to image slots.

In  Images, click an image slot to open its settings.

1. In Identification > Label, enter a label to rename the Image slot.
2. In Option, enable **Allow downscale** to resize the image when the image slot capacity is too low for the image resolution.
3. In Display, select a timer to be used in this image slot.

The selected timer is now loaded to an image slot and is ready to be displayed in layers.

10.2.6. Image signal

In  Images, select an image slot.

In **Signal**, adjust the following settings:

Setting name	Description / Setting selection
Settings	
Dynamic range	Select the Dynamic range used for this image slot (Auto, SDR)
Luminance	Select the nit level used for this image slot
Conversion Mode	
Mapping	For SDR with HLG as internal profile only <ul style="list-style-type: none"> • Inverse Tone Mapping: use if if internal processing and main input are using Limited Range color space • Direct Mapping
Reference	For HLG ↔ SSDR conversion only <ul style="list-style-type: none"> • Scene Referred: for camera content • Display Referred: for computer content
OETF	Square Root or Strict

10.2.7. Image aspect

Important

- Aspect ratio and Crop replace the image slot content and affect every layer using it. If needed, use crop at layer level in Live.
- Aspect ratio and Crop set for an image slot remain when changing the image source.

In  Images, select an image slot.

In **Aspect**, set the Aspect ratio or set image crop.

10.2.7.1. Set image aspect ratio

Change the image aspect ratio in all layers. Use these settings to correct the image aspect ratio if needed.

Setting name	Description / Setting selection
Aspect Ratio	
Transform to	Set the final aspect ratio for the image. This is the aspect ratio used for the Layer fill option. Native; 5:4; 4:3; 16:10; 15:9; 16:9; 21:9 or 64:27
Layer fill option	1:1; Centered; Fullscreen or Cropped

 **Option**

To keep the image unchanged, modify aspect ratio at layer level.

10.2.7.2. Set image crop

Crop input (ex: black bars) and keep only wanted area in layers.

Setting name	Description / Setting selection
Crop	
Finder	On/Off toggle. Display cropping area in output, use during setup and disable Finder to show the crop result output.
Top, Bottom, Left, Right	Enter cropping values (in pixels)

11. Formats and EDID

11.1. Formats

Create and manage up to 16 custom formats for:

- LED wall applications
- non-standard display applications (ex: pixel frequency over 165MHz or Dual-link outputs with single link formats 2400x700@60Hz)
- creating custom EDIDs (to reset or request the preferred EDID of connected outputs and inputs).

How it works

Custom format creation is based on existing templates and features two modes:

- In **CVT mode**, set the width, height and rate of the format and indicate if the format has reduced blanking intervals. The system computes the remaining format parameters according to the CVT 1.1 standard.
- In **FULL mode**, set all the parameters of the format (H&V front porch, H&V sync, H&V back porch, width, height, sync polarity, ...).

Reminder

- Max horizontal timings: 8192 pixels
- Max vertical timings: 4096 lines
- Max frequency/rate: 144Hz

11.1.1. Create a custom format

In  Formats

1. Select a Template format to prefill the settings.
2. Enter a label for the new custom format.
3. Select CVT or Full mode.
4. Enter the format settings (use the help in the right panel).
5. Click **Check** to verify if the custom format is valid and can be processed by the unit.
The format validity and format capacity are returned.
6. If format is valid, click **Save as** then select a memory slot.
7. Click **Save**.

The custom format is added to the formats library and can be used as a format preset.

11.1.2. Edit a custom format

In  Formats

1. Select the Custom format memory slot to edit as Template.
2. Edit the format settings.
3. Click **Check** to verify if the custom format is valid and can be processed by the unit.
4. If format is valid, click **Save as** then select the same memory slot.
5. Click **Overwrite**.

11.1.3. Delete a custom format

In  Formats

- Hover over Custom format then click .

The selected Custom format is deleted from the formats library.

11.2. EDID

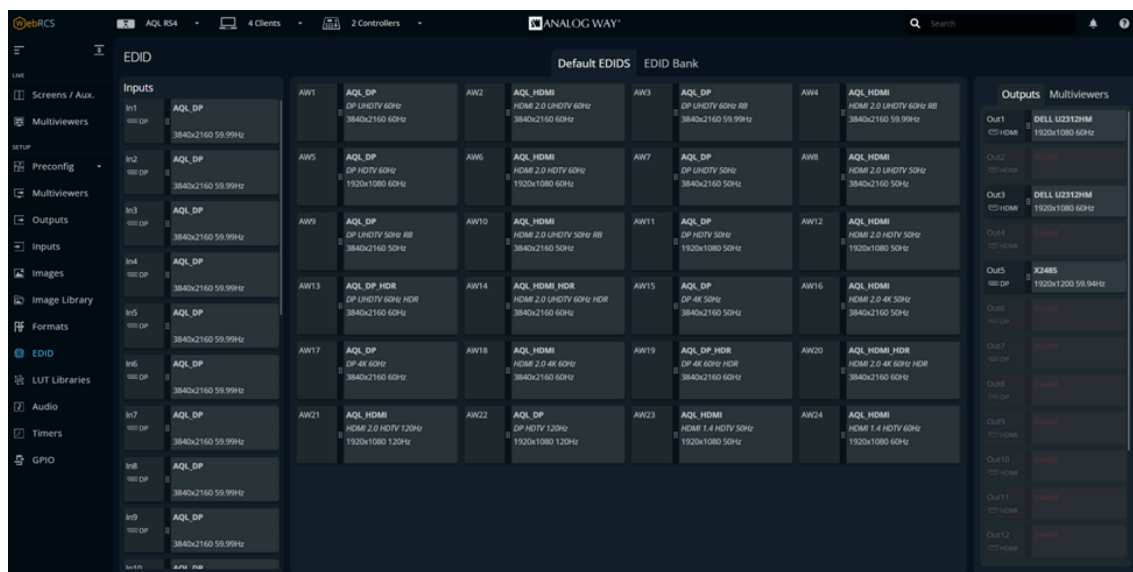

EDID menu

EDID is a metadata format used by displays to indicate their preferred format. A LivePremier unit receives EDIDs from connected inputs and outputs.

It is possible to store these EDIDs in a memory called EDID bank.

It is then possible to overwrite the preferred format of inputs and outputs.

More options

Extended EDID and DisplayID are also supported by LivePremier devices.

11.2.1. EDID bank

LivePremier units have, by default, 24 preinstalled EDIDs which correspond to standard formats for DisplayPort and HDMI outputs. In addition, the EDID bank can store up to 100 EDID memories saved from connected input / outputs, custom formats or EDIDs files imported from computer.

11.2.2. Save an EDID from inputs and outputs

To save EDIDs in the EDID bank:

- Drag and drop EDIDs from inputs and outputs to the EDID bank.

11.2.3. Replace an Input EDID with an EDID from the bank

To set a new preferred format on an Input:

- Drag and drop an EDID from the bank to the input slot.



Note

If an EDID in the bank was modified, drag and drop it to the input to update it.

To reset an input preferred format:

- Hover over the input and click the reset icon



11.2.4. Set a template format for an EDID

In  EDID

1. Hover over an input EDID or an EDID created in the bank and click  in the top right corner to show more settings.
2. Click **Template** and select the format to use as EDID.
3. Click **Apply to EDID**.

The EDID is now usable as an input preferred format.

11.2.5. Set a custom format for an EDID

It is possible to change the preferred format of an input EDID with the settings of a created Custom format.

In  EDID

1. Hover over an input EDID or an EDID created in the bank and click  in the top right corner to show more settings.
2. Click **Custom format** and select the memory to use as EDID.
3. Click **Apply to EDID**.
The EDID with custom format is now usable as an input preferred format.

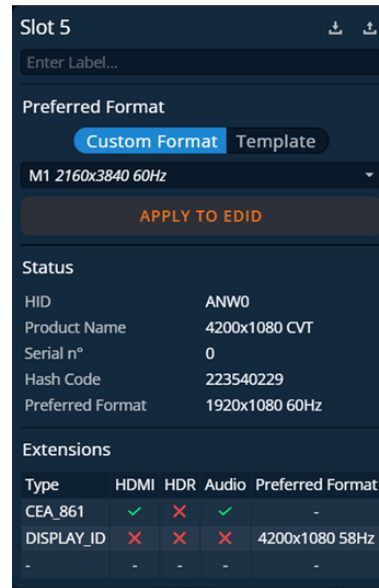



Tip

Clicking  also displays more EDID information such as extensions (CEA, and Display ID).



11.2.6. Export an EDID to computer

In  EDID

1. Hover over an EDID and click  in the top right corner to show more settings.
2. Click  to download the EDID to the computer.

11.2.7. Import an EDID from computer

In  EDID

1. Hover over an EDID and click  in the top right corner to show more settings.
2. Click  and select the EDID file to upload from the computer to the unit.

11.2.8. Delete a custom EDID

In  EDID

- Hover over an EDID in the EDID bank then click .

The selected custom EDID is deleted from the EDID bank.

11.2.9. AW EDID Editor

Free AW tool

The AW EDID Editor is a free software available on www.analogway.com [http://www.analogway.com/].

AW EDID Editor is a software developed by Analog Way to create, edit and import/export EDID files. Import the EDID file in the Web RCS to change the preferred format of any input and solve compatibility issues. AW EDID Editor supports EDID, DisplayID and CEA-861-G extension.

12. LUT Libraries

Manage Lookup Tables (LUTs)

LivePremier uses 33x33x33 3D LUTs to instantly transform the colors of an Input or Output according to a mapping table.

The LUTs are separated in three types:

Conversion LUTs	Used to convert the signal of an input (ex: SDR to HDR)
Correction LUTs	Used to change the color tone of an input or output (ex: cooler or warmer colors, black and white, etc.)
CremaTTe 3D LUTs	Used to key an input according to a LUT created with AW CremaTTe 3D

12.1. Creating a CremaTTe 3D LUT using a LivePremier live input

Free AW tool

AW CremaTTe 3D is a free tool used to create a keying LUT using the inputs of a LivePremier device. It is available on www.analogway.com [<http://www.analogway.com/>].

1. Run AW CremaTTe 3D.
 - a. In the Connection Wizard STEP 1, enter the IP address of the LivePremier device and click **Connect**.
 - b. In STEP 2, select the input to key and a slot in the CremaTTe 3D LUT library.

The input's color space must be the same as the color space set for processing in system pre-configuration.

- c. Click **Apply and go**.

When AW CremaTTe 3D is connected, the selected input is set to CremaTTe 3D Keying mode using the selected LUT slot.

In the AW CremaTTe 3D main window, a capture of the selected input is displayed in the preview.

2. If needed, **Freeze** the input in the Web RCS and click **Capture Again** in AW CremaTTe 3D.
3. On the image preview, click a pixel in the area to key.

The preview is updated with the CremaTTe 3D keying to show the background image.

The CremaTTe 3D LUT is automatically saved in the selected LUT library slot

Option

If needed, click Export.cube to export the LUT file or download it from the LUT library in the Web RCS.

12.2. Importing a LUT

Go to  LUT Libraries

1. In the Conversion, Correction or CremaTTe 3D LUT library, click **Upload LUT File** on an empty slot to open the file explorer and select a custom LUT to transfer.

The Upload LUT form is displayed.



2. Enter LUT label and fill the parameters corresponding to this LUT.

Make sure to set the parameters correctly as they will be used for processing.

3. Click **Upload**.

The selected LUT is imported to the corresponding library.

12.3. Using a LUT

Conversion and Correction LUTs can be used in the  Inputs and  Outputs menus.

A CremaTTe 3D LUT can be used in the  Inputs > Group Keying menu.

12.4. Export a LUT to computer

In  LUT Libraries

- Hover over an LUT slot and click  to download the LUT to the computer.

12.5. Delete a LUT

in  LUT Libraries

- Hover over an LUT slot then click .

The selected LUT is deleted from the LUT library.

13. Audio, Timers and GPIO

13.1. Audio

LivePremier units can manage audio routing with and without Dante audio network.

Using the Dante audio, LivePremier can manage up to 64 input channels and 64 output channels at 48 kHz.

Assign audio channels from inputs and Dante receivers to:

- outputs
- multiviewers
- Dante transmitters.

Note

- LivePremier can manage Dante routing. For Dante control, use Dante software.
- Dante audio can only be controlled from the Dante ports.
- Dante primary & secondary connections have a dedicated LAN separated from LivePremier control.

13.1.1. Audio routing

In  Audio > Routing

- Assign audio channels from receivers to transmitters

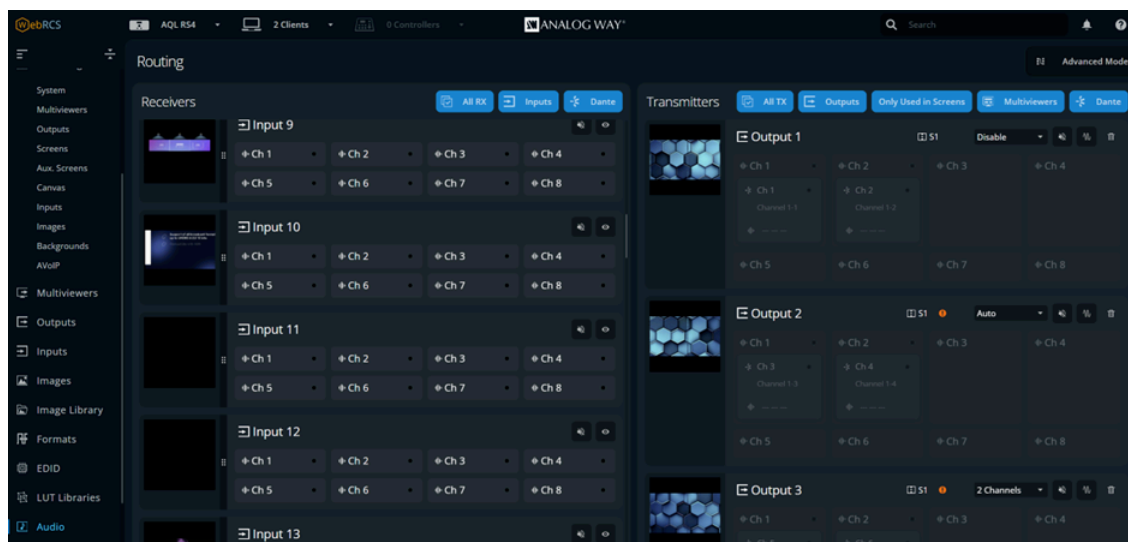

Audio routing menu

LivePremier units can mix all audio channels. It is possible to route:





- inputs to outputs (and multiviewers)
- inputs to Dante
- Dante to outputs (and multiviewers)

- Dante to Dante.

Note

8-plug HDMI inputs support up to 4 audio channels per input.

Audio routing menu:

- Click  to mute the selected audio channels.
- Click  to highlight transmitter channels using this receiver channels.
Channel transmitters (Outputs and Dante OUT) audio channels are in the right-side panel:
- Click  to mute the selected audio channels.
- Click  to send audio test tone.
- Click  to delete the audio routing.
- Set the number of channels to send (outputs only)
- Enter (or reset) channel labels (Dante only)

Top bar:

- Use the filter buttons to show/hide audio channels.
- Enable **Advanced Routing Mode** for single channel routing.

13.1.2. Default audio routing

Default audio routing assigns all audio channels of a receiver to the audio channels of a transmitter.

In  Audio > Routing

- Drag and drop a receiver channel to a transmitter channel.
All audio channels of the receiver are routed to all audio channels of the transmitter.

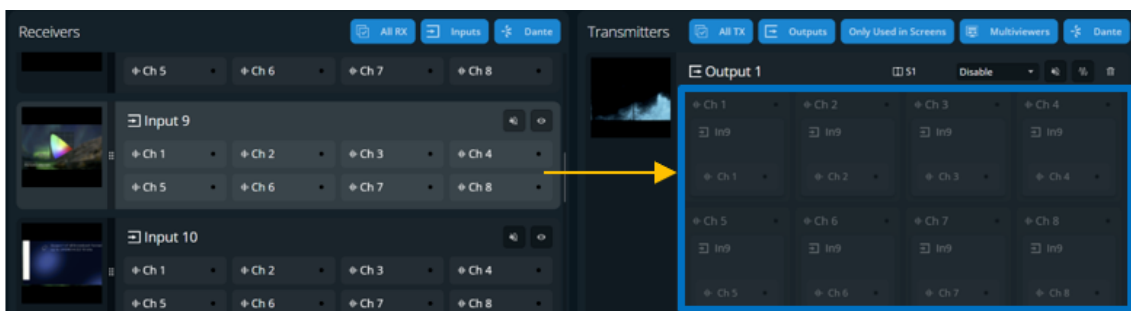

Default audio routing

13.1.3. Advanced audio routing (single channel)

Advanced audio routing assigns one single audio channel of a receiver to one audio channel of a transmitter.

In  Audio > Routing

1. In the top bar, enable **Advanced Routing Mode**.
2. Drag and drop a receiver channel to a transmitter channel.

The selected audio channel of the receiver is routed to the selected audio channels of the transmitter.

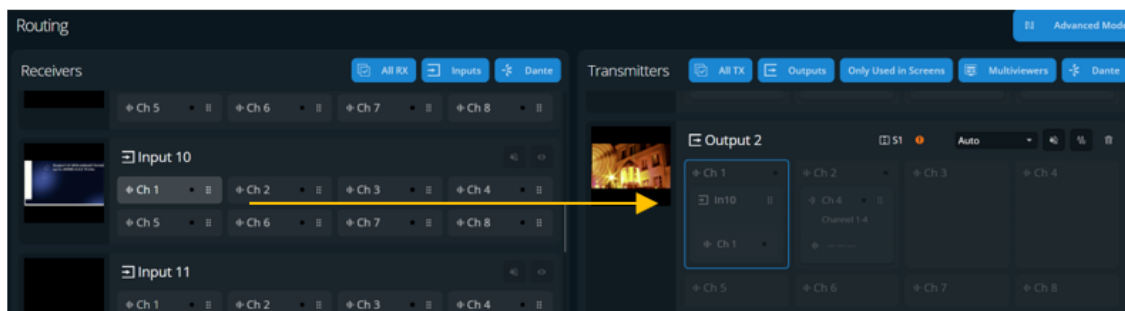

Advanced audio routing (single channel)

13.2. Timers

Timers are time-based contents to be displayed in Screens, Aux Screens and Multiviewers.

LivePremier units can generate up to four timers in three different modes:

- Current time
- Count down
- Count up (Stopwatch)

13.2.1. Create a timer

In  Timers



1. Select a timer to use and enter a label if needed.
2. Select the timer type:
 - a. In **Current time** mode, select the display format and set timer offset if needed.
 - b. In **Count down** mode, select the display format and set the countdown duration.
 - c. In **Count up** mode, select the display format.
3. For Count down and Count up modes, use the buttons at the top to run, pause and stop the counters.
4. In **Color**, enter the hexadecimal color code or click the color preview to open the color setter to set a color and opacity for the content and the background.

Note

Current time displays the device time set in Device > Device Overview.

13.2.2. Control counter timers in Live menus

It is possible to run, pause and stop the counters directly in the source panel in *Live > Screens* and *Live > Multiviewers*.

1. In  Screens or  Multiviewers, open the timers source panel.
 2. Hover over a timer and click  to show control options.
 3. Click Setup to enter timer settings.
- Or
- Use the buttons to run, pause and stop the counter.

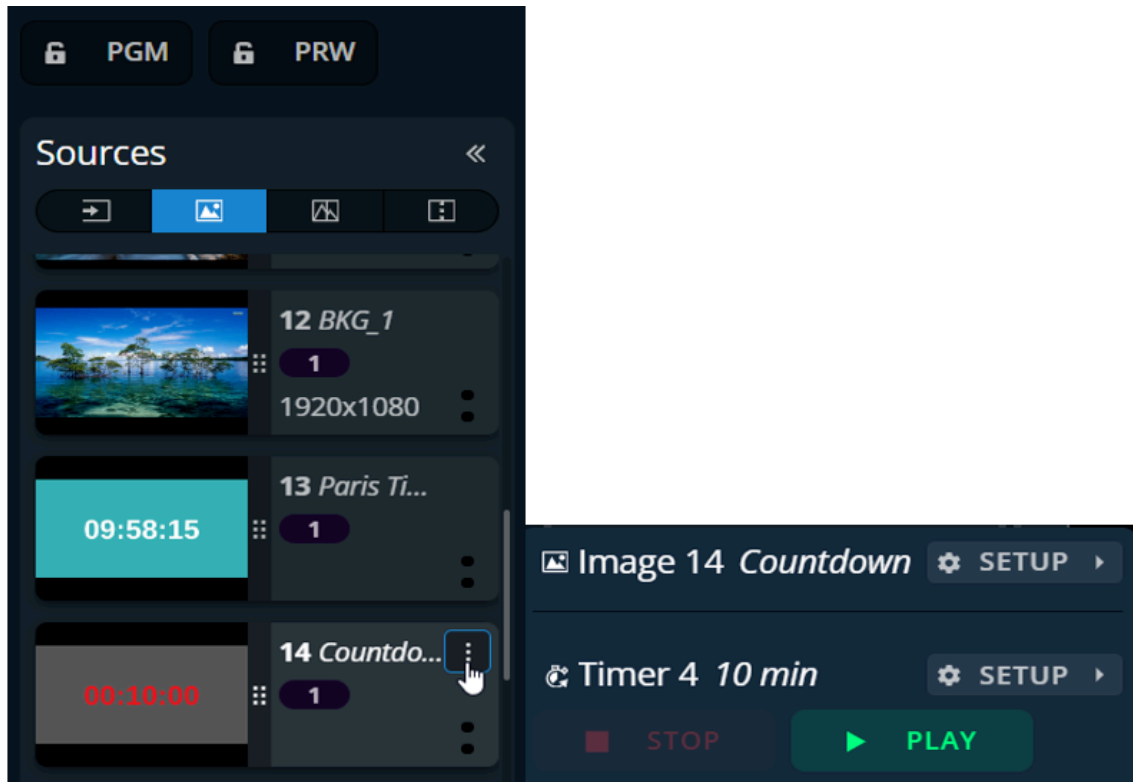

Timer controls in Screens

13.2.3. Use timers in Screens and Aux. Screens

Timers can be assigned to image slots. They can then be used in layers just like regular images.

In  Images

1. Click an image slot.
The image slot settings are displayed.
2. In Identification > Label, enter a label to rename the Image slot.
3. In Option, enable Allow downscale to resize the image when the image slot capacity is too low for the image resolution.
4. In Content, select a timer to be used in this image slot.
The selected timer is now loaded as an image slot and is ready to be displayed in layers.

Tip

Timers can be displayed in Multiviewers without being assigned as image slots.

13.3. GPIO

The GPIO (or Tally) is a set of inputs / outputs to control the device externally and get a feedback from the device. LivePremier units are equipped with 2x GPI and 8x GPO.

13.3.1. Pins table and GPIO connection

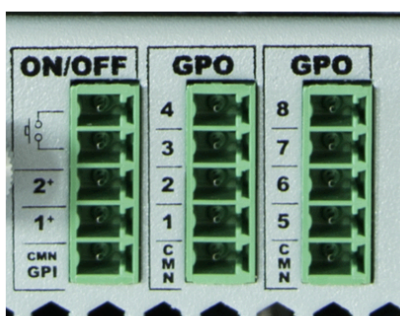

ON/OFF 2	GPO 4	GPO 8
ON/OFF 1	GPO 3	GPO 7
GPI 2	GPO 2	GPO 6
GPI 1	GPO 1	GPO 5
GPI return (common)	GPO return (common)	GPO return (common)

GPIO pins table

GPIO are optically isolated MOSFET, working as mechanical relays.

- GPI 1 and 2 have a common pin.
- GPO 1, 2, 3 and 4 have a common pin.
- GPO 5, 6, 7 and 8 have a common pin.

Each GPI can sink a current between 10mA/3V to 45mA/48V.

Each GPO can sink a current of up to 300mA maximum in the closed state and can accept up to 48V in the opened state.

The courant leakage is less than 1µA when opened and the resistance is less than 2 ohms when closed.

More information

See  GPIO Phoenix connection ^[p.137].

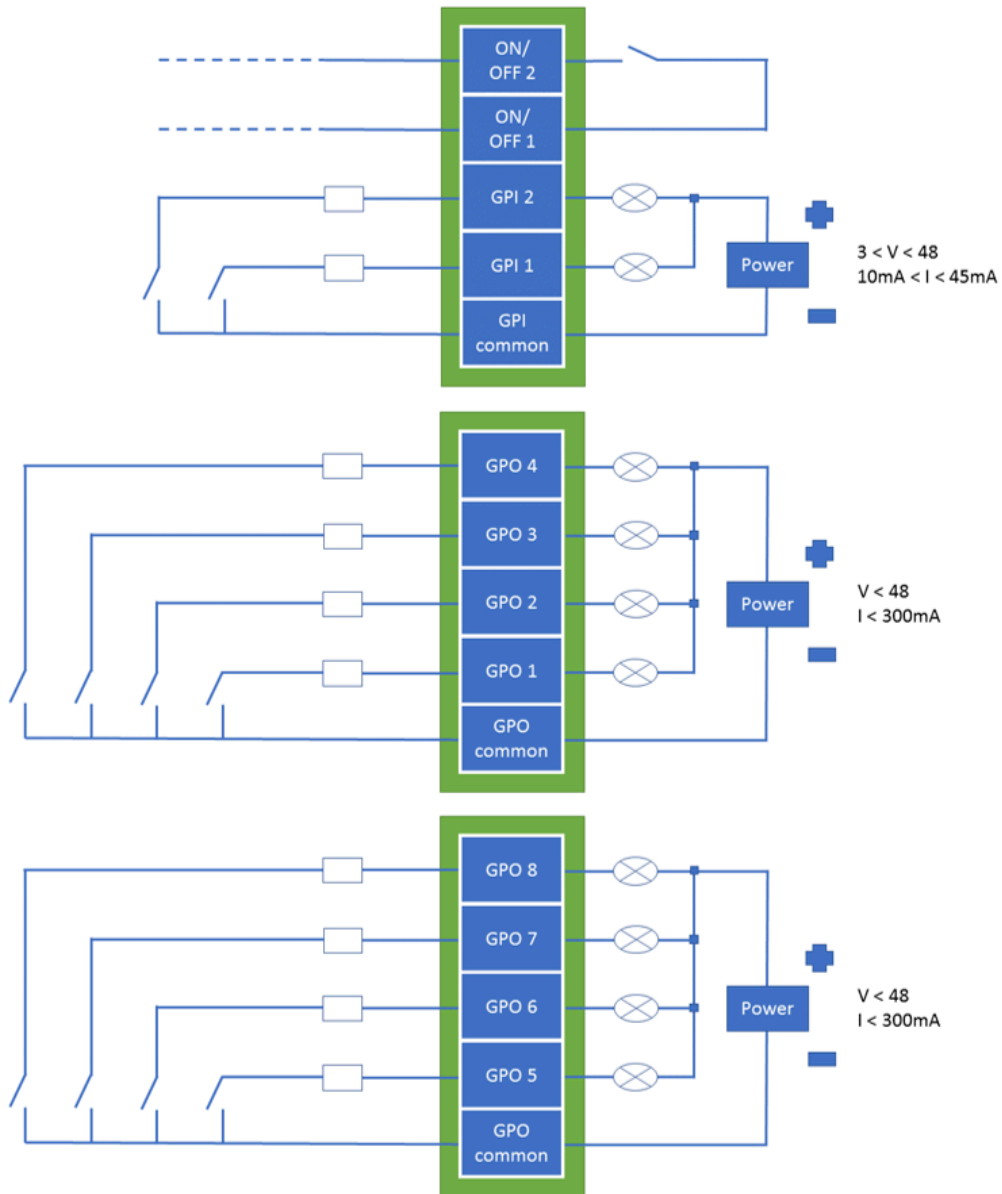

GPIO Phoenix connection example

13.3.2. On/Off switch pins

A switch can be placed between the On/Off pins to turn the LivePremier unit on and off. It will work as the front panel switch: when the device is on, closing the switch will request the device to power down. If the switch remains closed for more than four seconds, a forced power down is performed. When the device is off, closing the switch will turn on the device.

13.3.3. Set GPIO in the Web RCS

In  GPIO

- Set the GPI and GPO actions.

GPI actions

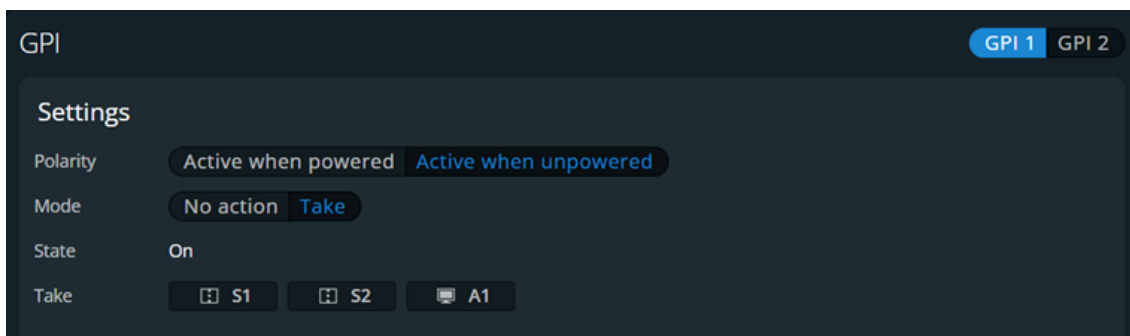

GPI

Setting name	Description / Setting selection
Polarity	Set when the GPI connector is active (when powered or when unpowered)
Mode	Select No action to disable triggers from this GPI Select Take and associate a Screen to trigger the transition when using the GPI
Take	In Take mode, select the Screen to take when triggering the GPI
State	Check if the GPI is currently On or Off

GPO actions

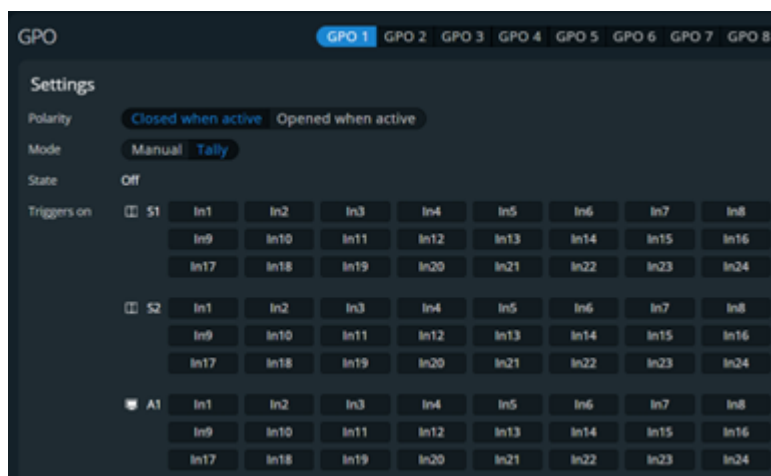

GPO

Setting name	Description / Setting selection
Polarity	Set the GPO connector status when active (Closed or Opened)
Mode	In Manual mode, the state can be defined by a user action through the Web RCS or by an automation controller In Tally mode, the tally level will change when a defined input is used in a Screen
Screen X (one line per enabled Screen in Tally mode)	Set the association of Input-Screen for Tally mode Select one input per Screen to return in the tally
State	In Manual mode, set if the GPO is currently On or Off In Tally mode, check if the GPO is currently On or Off

14. Screens / Aux.

Screens / Aux. is the main page for controlling a show after all pre-configurations are set:

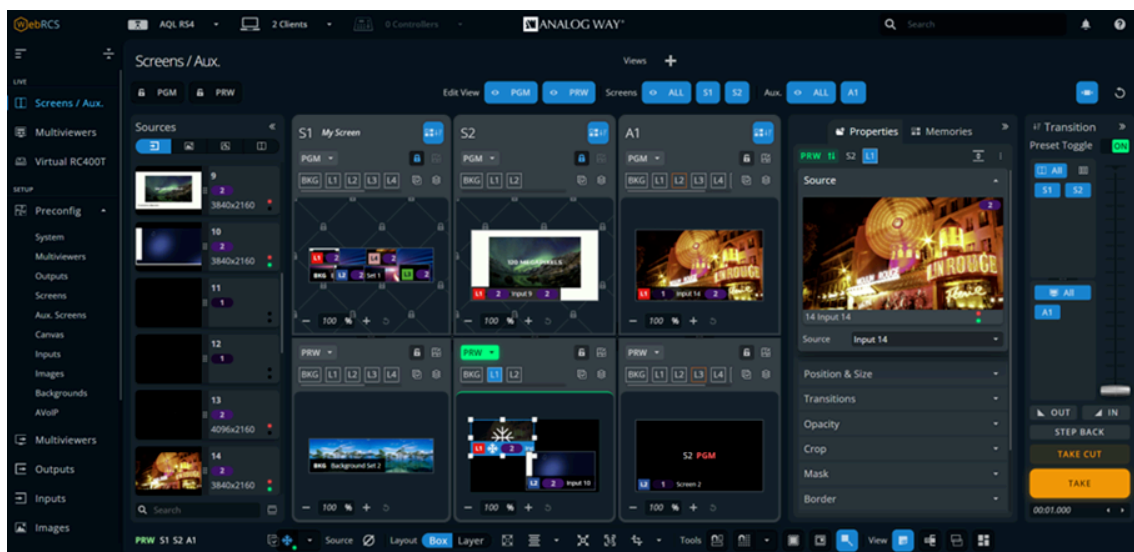

- Display content in layers in Screens and Aux Screens
- Create dynamic layer transitions
- Freeze inputs and Screen layers
- Transition Preview to Program
- Save and Load Screen memories and Master memories



Live – Screens / Aux. menu

14.1. Screens menu interface

Easily adjust various working areas with the following tools:

- Click on  to reduce the side menus and display more screen space.
- Slide the horizontal scroll bars to display any hidden items (e.g. Screens, layers).
- Click on  /  (or use Ctrl key and the mouse wheel) for a closer view of a selected screen area.

Tip

Hold down the **Alt** key and use the mouse wheel to change the position of the screen within the Screen area.

14.1.1. Program and Preview



Screens / Aux. is composed of **Program** (PGM) and **Preview** (PRW) windows for each screen, as well as access to sources, layer properties, memories and transition panel. Program windows are always displayed on top of Preview windows and are locked by default.



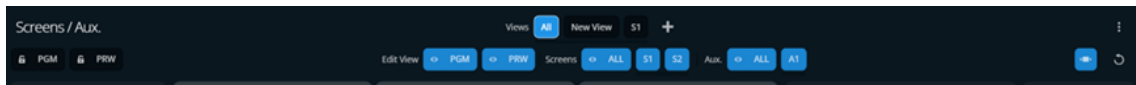

14.1.2. Views

The Live menu offers a customizable view of the workspace for Screens and Aux Screens.

14.1.2.1. View filters – Top bar buttons



View filters

Setting name	Description / Setting selection
 PGM / PRW	Toggle to lock / unlock all the Screens and Aux Screens Prevent edits during Live, or lock Program to only edit in Preview Layers cannot be modified; Memories cannot be loaded but transition can be triggered
 PGM / PRW / ALL	Toggle to show/hide all Program, Preview, Screens and/or Aux. Screens Use the scroller when displaying more than five Screens.
	Reset to default view (Screens visibility, size and order)
	Toggle to adjust the view to your screen size.

Note

Hiding and locking Screens do not affect the Transition. To exclude a Screen from transition, see [Transitions - Right panel](#) [p.146].

14.1.2.2. Resize and reorder Screen windows

In addition to showing and hiding Screens, it is also possible to resize and reorder the Screens in the interface.

- Use drag and drop on a border to resize the Screen width or height.
- Use drag and drop on a Screen name to move it and change the Screens order.

14.1.2.3. Save a view memory

The user can save custom views in memories.

Note

Screen locks are excluded from view memories.

In  Screens / Aux.

1. Edit the workspace.
2. In Edit View, select the Screens and Aux. Screens to show/hide.
3. Resize and reorder the Screens.
4. In Views, click  to create a view memory with the current view.

5. Enter a name for the View memory

14.1.2.4. Load / edit a view memory

In  Screens / Aux.

1. Click a view memory.

The selected view memory is loaded to the workspace.

If changes are made to the view, a * appears in the view memory.



2. Click the view memory to show more options.



3. Click **Save** to overwrite the view memory with the new settings.

Or

Click **Revert** to reload the view memory.

14.1.2.5. Rename, hide or delete a view memory

In  Screens / Aux, click  in Views to open a detailed view of all view memories.

- Click the label to rename a view memory.
- Click  to hide a view from the bar.
- Click  to delete a view memory.

14.1.3. Sources - Left panel

The Sources are located in the left panel. Click the icons to show the corresponding sources:



Note

- Program Screens can only be used as content for Aux Screens and Split layers.
- Backgrounds can only be used in Background layers.

The following information are displayed per source content:

- Source number
- Source label
- Source capacity
- Resolution
- The tallies turn red and green if the content is used in a

 **Program** and/or  **Preview** Screen.

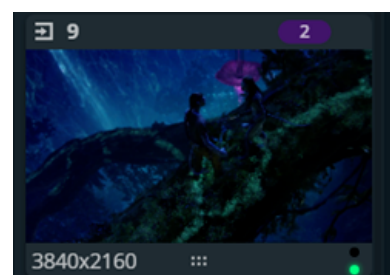

Options

On hover, click  in the top-right corner of a source thumbnail to open options (ex: Freeze an input, access the setup menu for the selected source or select an NDI source, if available).

Tip

- Use the search bar at the bottom of the Sources panel to find a source or to display a batch of sources with the same char in the label.
- Click on the icon next to the search bar to downsize or expand the sources snapshots.

14.1.4. Layer selection

This bar shows tools and all available layers for the corresponding Screen

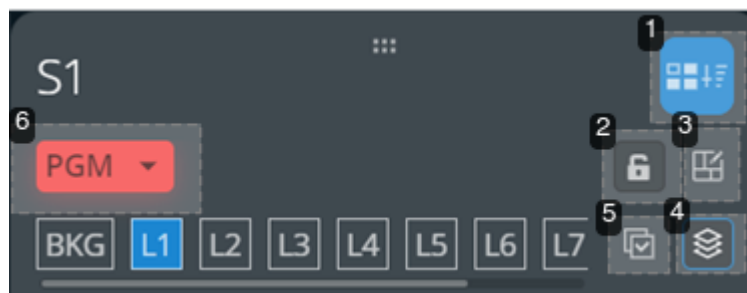

1. Transition selection

Toggle to include / exclude the Screen or Aux from transition selection.

2. Lock

Toggle to lock / unlock the selected PGM or PRW Screen.

When locked, layers cannot be modified; Memories cannot be loaded but transition can be triggered.

3. Layout editor

Open the layout editor.

For more information, see  Screen layout editor ^[p.143].

4. Detailed view of all layers

Open a detailed view of all layers in the selected Screen (layer capacity, associated regions, source label and source capacity).

- Click  to empty the layer content and keep other properties.

- Click  to freeze layer* / input.

* only current layer content is frozen; layer properties can still be modified

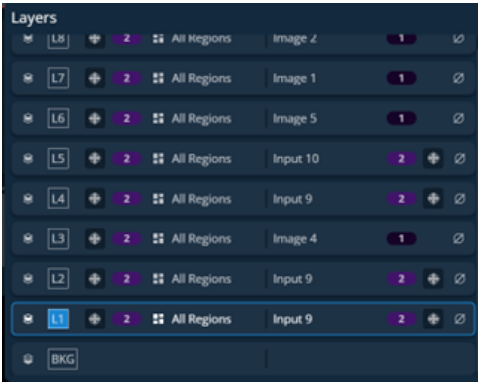

5. Select all layers



Select all layers in this Screen.



Deselect all layers in this Screen.

6. PGM or PRW Screen options

Open the Screen options.

For more information, see [PGM and PRW buttons – Screen controls \[p.144\]](#).



Tip

- Hold **Ctrl** or **Shift** to select multiple layers.
- Scroll the slide bar under the Layer letters to access the layers that are not displayed.

14.1.5. Screen layout editor

Click  to open the layout editor, a smart tool to place layers in the Screen easily.

Layout editor view	Setting	Description / Setting selection
	Mode	<p>Mosaic places layers in custom grid. Mosaic layout automatically arranges the layers in rows. The last slot is empty if the number of layers is odd.</p> <p>Cascade places all layers in cascade except Layer 1 in Fullscreen.</p>
	Columns & Rows	Create a custom grid for the Mosaic mode
	Margin	Reduce the area of this layout (ex: Top: 50% will ignore the top half of the Screen)
	Spacing	In Mosaic mode, set gaps between columns and/or rows
	Autofill	Select the source content to put in layers
	Layers	Select layers to include/exclude from this layout

 **Note**

The layout editor is only available for Screens with layers.



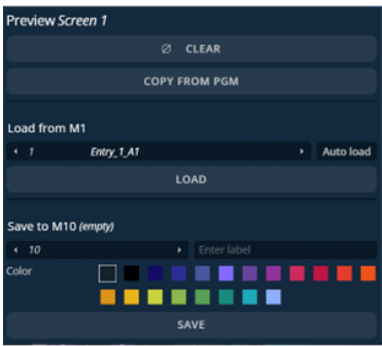

14.1.6. PGM and PRW buttons – Screen controls





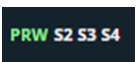









Click the **PGM** or **PRW** button in any Screen to open options.

Screen controls view	Setting	Description / Setting selection
	Clear	Empty the layers content and keep other properties for this PGM or PRW Screen
	Copy from PGM	Copy layers settings from the corresponding PGM Screen (PRW only)
	Load from	Load the Layer settings from a selected Screen Memory
	Auto load	Enable auto load to display on Screen directly when selecting the Screen memory
	Save to	Save the current Layer settings for this PGM or PRW Screen in a selected Screen memory
	Label	Enter a label for the Master Memory. Select a color for the memory slot



14.1.7. Bottom bar buttons

In addition to the layout editor, use the buttons in the bottom bar to help setting the layers in Screens.

Button	Button description
Action buttons	
	Screen selection for transition (same as the Screen transition filter in the right panel)
	Select all layers in the Screens selected for transition (indicated on the left side)
	Deselect all layers
	Freeze current layer selection (PGM or PRW) Freeze current layer selection simultaneously on PRW & PGM
	Empty the layers content and keep other properties for the selected layers
Mode	<p>Box mode: the selected layers are handled as one block. A change is applied to an entire block (ex: Middle center position puts the block in the center of the Screen while maintaining the layers layout within the Screen)</p> <p>Layer mode: a change is applied individually to each selected layer (ex: Middle center position puts each layer in the center of the Screen, overlapping)</p>

	Scale the layer selection to full screen
	Align the layer selection (Top, Bottom, Left, Right, Corner, Center, Horizontal or Vertical)
	Set layer size to source ratio (reduce size to cancel empty area of the layer)
	Set layer size to content size (5:4, 4:3, 16:10, 15:9, 16:9, 21:9 or source size)
	Set layer size to an aspect ratio
Assist buttons (On/Off toggle buttons)	
	Snap to Screen border and other layer borders
	Snap to grid cells Click the arrow to set the grid (columns & rows)
	Force layers outside of Screen to snap to Screen borders
	Force layers to stay inside of Screen borders
	Keep aspect ratio
Interface buttons (On/Off toggle buttons)	
	Hide empty and preempted items (layers and sources)
	Hide content outside of Screen borders
	Hide content to display only layers wireframe
	Show Screen regions and outputs

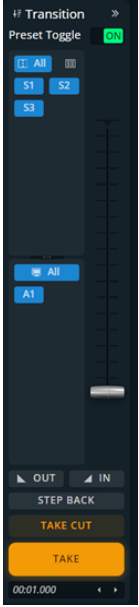
14.1.8. Transitions - Right panel







Transitions panel view	Setting	Description / Setting selection
	Preset Toggle	<p>Copy Program to Preview after the transition</p> <p>If Preset Toggle is enabled for a Screen, the layers in PGM replace the layers in PRW during a Take or Take Cut ("swap" effect).</p> <p>If Preset Toggle is disabled, the layers in PRW are copied to PGM and remain in PRW Screens during a Take or Take Cut.</p>
	Panel size	Adjust the size of the Screens/ Aux selection panels and change number of columns by clicking on 
	Screen transition filter	Select the Screens and Aux affected by transition (by default, all Screens and all Aux are selected). Also indicated in the bottom bar.
	Fade Out	Fade the selected screens to black
	Fade In	Fade the selected screens to return from black
	T-Bar	Transition the selection manually
	Step Back	Revert the last change in layer settings. Does not work with a deletion.
	Take Cut	<p>Instant transition. Replace PGM layers with the PRW layers for the selected Screens with an immediate cut effect.</p> <p>The Global transition duration and the layers settings for Transitions, Speed and Timing are Not applied.</p>
Take	<p>Replace the PGM layers with the PRW layers for the selected Screens.</p> <p>Set the Global transition duration under the Take button (minutes:seconds.milliseconds).</p> <p>The layers settings for Transitions, Speed and Timing are applied to the Take.</p>	

14.2. Layer properties

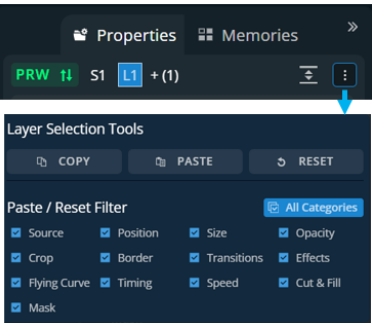
When a layer is selected, the following layer settings are available in the Properties tab:

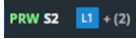
Setting	Description / Setting selection
Source	Select a content for this layer
Position & Size	Select the anchor point for adjustments of layer's position and size Set layer Vertical and Horizontal position in pixels Set layer Height and Width in pixels
Transitions	Set Opening and Closing transition during Take
Cut & Fill	Set Cut & Fill. Displayed if enabled at layer level in Preconfig For more information, see  Cut & Fill effect ^[p.151] .
Opacity	Set layer transparency
Crop	Set layer cropping (zoom effect with content resized) in percentage or pixels (top, bottom, left and right) and layer aspect (None; 1:1; Centered; Fullscreen; Cropped)
Mask	Set layer masking (content not resized) in percentage or pixels (top, bottom, left and right)
Border	Set a layer border and layer shadow
Effects	Set color filters (Black and white; Negative; Sepia; Solar) and Horizontal or Vertical flip
Speed	Set the acceleration curve for the transition during Take
Timing	Set the timings for delayed layer transition during Take

14.2.1. Layer selection and tools

Layer selection view	Setting	Description / Setting selection
		Keep the layer selection and toggle to Program or Preview
		Current layer selection. The layer indicated is the Reference layer. The following layers will have the same settings applied if possible.
	Copy / Paste / Reset 	Click  to open the selection menu. Copy, paste or reset multiple layer properties. By default, all layer properties are selected.
		Expand to open all layer properties details
		Collapse all layer properties

14.2.2. Layer position and size

Note

A layer with an orange frame indicates a content visibility issue due to a layer position - the layer is partially unprocessed. Toggle Regions visibility for a better overview of the issue and adjust the layer position.

14.2.2.1. Set layer position with the layout editor

Layouts are predefined templates arranging layers automatically in one Screen.

In  Screens / Aux.

1. Click  in the selected Screen to open the layout editor.
2. Create a custom layout in Mosaic or Cascade mode.
3. Auto-fill the layers with a type of source.
4. Select layers to include/exclude from the layout.
5. Apply the layout on Screen.

All the Screen layers are arranged automatically.

More information

See  Screen layout editor ^[p.143].

14.2.2.2. Set layer position and size manually

In  Screens / Aux.

1. Select a layer.

The selected layer is highlighted.
2. Use drag and drop on the layer to move it in the Screen.
3. Use drag and drop on a layer border point to change its size.

Option

It is also possible to use the Properties panel:

1. Go to Properties, click **Position** and **Size** to show the corresponding settings.
2. Set the Position and Size by entering values or using drag and drop.

Note

It is possible to change the layer's anchor point to focus the modification of layer's position and size around this point.

 **Tip**

- In the **Size** property, click  to keep the aspect ratio when changing the size values.
- Use bottom bar buttons (Keep aspect ratio, snap to items) to have layers of equal size or alignment. When enabling snap to item, layer borders are automatically attracted to other objects (Screen border, layer border, grid snap point) to match their position or size.

14.2.3. Layer source

14.2.3.1. Assign content to a layer

In  Screens / Aux.

1. Click a source icon in the left panel.
2. Select a Layer or make sure it is available for drag and drop.
3. Drag a content and drop it in the layer.

The content thumbnail is displayed in the layer with the source label and capacity at the bottom.

 **Other ways to assign a content:**

- Drag and drop the selected content into the layer letter icon on the top of each screen.
- Select a Layer then go to Properties > Source and select the content in the drop-down list.



14.2.3.2. Select NDI source for a layer

 **Note**

You must have at least one NDI input to select an NDI source for a layer.

NDI inputs are set in Preconfig > Inputs. For more information, see  Set an NDI input ^[p.94].

In  Screens / Aux.

1. Select **Inputs** in sources panel.
2. Click  in the bottom-right corner of an NDI input thumbnail.
3. Click on  to update the list of detected sources.
4. Select a source from the drop-down list.
5. Enter or modify the existing buffer.

Real-time status indicates CPU, GPU, FPGA and network load.

Adjust a buffer size accordingly to maintain a quality of audio/video in case of network deficiency.

6. Drag a content and drop it in the layer.

14.2.3.3. Set a colored layer

In  Screens / Aux.

1. Select a layer.
2. In **Properties**, click **Source** to show the corresponding settings.
3. In the Source drop-down list, select **Color**.
4. In Color, enter the hexadecimal color code or click the color preview to open the color picker.

14.2.3.4. Assign content to a Screen backgrounds

In  Screens / Aux.

1. Click the Backgrounds icon  in the left panel.
2. Drag a Background set to a Screen background layer or BKG icon.
The Background set content is displayed in the Screen background.

More information on Background sets

See  Preconfig > Backgrounds ^[p.96].

14.2.3.5. Set a colored background

In addition to the eight background sets, each Screen can display a color in the background layer.

In  Screens / Aux.

1. Select a background layer (BKG).
2. In **Properties**, click **Source** to show the corresponding settings.
3. In the Source drop-down list, select **None**.
4. In Color, enter the hexadecimal color code or click the color preview to open the color picker.

Note



- The background color is always present and can be displayed during a background set Crossfade.
- By default, all Screens display a background with black color (#000000).

14.2.3.6. Remove a content from a layer

In  Screens / Aux.

1. Select one or multiple layers.
2. Press the **Del** key to remove all layer's content (this cannot be reversed).
The selected layers are empty but other properties are kept.

 **Other ways to remove content:**

- Use the PGM or PRW buttons to clear the entire Screen.
- Click  next to the layer letter icons then click  to clear the corresponding layer.
- Go to Properties > Source, then click  or select None in the source drop-down list.

14.2.4. Cut & Fill effect

Cut & Fill keys the content of a layer using an input or an image as the alpha channel. Usually, the Cut content (or mask), is a grey level content: the darker the grey level, the more transparent the Fill content.

 **Note**

If a colored content is used as Cut, the Luma level of the content is used to key the Fill content.



Layer with Fill content



Cut content



Layer with Cut & Fill 

14.2.4.1. Resource used by Cut & Fill

 **Prerequisite**

The Cut & Fill feature must be enabled in the Preconfig as it uses the resources of two layers of same capacity.

Go to **Preconfig > Screens** to add the Cut & Fill feature  to the corresponding layer. Only this layer will be able to use Cut & Fill.

 **More information on layer creation in Preconfig**

See  [Create a Screen \[p.79\]](#).

14.2.4.2. Set Cut & Fill in layer

In  Screens / Aux.

1. Select a layer with Cut & Fill .
2. Assign a content in the layer.
3. In **Properties**, click **Cut&Fill** to show the corresponding settings.
4. Toggle the enable button.
5. In **Source**, click the drop-down list and select the Cut content.

The Cut & Fill effect is set.

Optional

- Use the Curve setting to adjust the transparency level of the Cut & Fill.
- Enable the Negative filter to invert the cutting levels (bright content becomes transparent).
- Set flipping or cropping for the Cut content.

14.2.5. Set layer opacity

In  Screens / Aux.

1. Select a layer.
2. In **Properties**, click **Opacity** to show the corresponding setting.
3. Set the transparency level with a value from 0 to 256.

14.2.6. Set layer crop and aspect

Layer crop is set for a layer and only affects the content used in this layer without changing the native content.

In  Screens / Aux.

1. Select a layer.
2. In **Properties**, click **Crop** to show the corresponding settings.
3. Set the cropping per side in percentage or pixels.
4. In **Aspect**, set how the content is filling the layer (**1:1**; **Centered**; **Fullscreen, Cropped** or **None**).

Note

- The aspect set at layer level overrides the aspect set at content level (input or image).
- When multiple layers are selected, the crop is set on the following layers in percentage so the ratio stays the same even with content with different resolutions.

14.2.7. Set layer mask

Layer mask looks like an erasing effect and the content is not resized. It is set for a layer and only affects the content used in this layer without changing the native content.

In  Screens / Aux.

1. Select a layer.
2. In **Properties**, click **Mask** to show the corresponding settings.
3. Set the masking per side in percentage or pixels.

 **Note**

When multiple layers are selected, the crop is set on the following layers in percentage so the ratio stays the same even with content with different resolutions.

14.2.8. Set layer border

In  Screens / Aux.

1. Select a layer.
2. In **Properties**, click **Border** to show the corresponding settings.
3. Toggle **Edge** to apply layer border settings.
4. Toggle **Smooth** to create a fading effect on the borders.
5. In **Edge / Smooth**, enter the hexadecimal color code or click the color preview to open the color picker.
6. Set the H size, V size and Opacity.
7. If needed, toggle **Round** to apply round corners settings and set the round corner radius.

14.2.9. Set layer smooth border

Setting a smooth border without enabling **Edge** creates a smooth effect around the content.

In  Screens / Aux.

1. Select a layer.
2. In **Properties**, click **Border** to show the corresponding settings.
3. Keep the **Edge** toggle disabled.
4. Toggle **Smooth** to create a fading effect around the content.
5. In **Edge / Smooth**, set the H size, V size and Opacity.
6. If needed, toggle **Round** to apply round corners settings and set the round corner radius.

14.2.10. Set layer shadow

In  Screens / Aux.

1. Select a layer.
2. In **Properties**, click **Border** to show the corresponding settings.
3. Toggle **Shadow** to apply layer shadow settings.
4. Set the X and Y positions for the shadow direction.
5. Set the shadow Opacity level.
6. If needed, toggle **Round** to apply round corners settings and set the round corner radius

14.2.11. Set layer color filter

In  Screens / Aux.

1. Select a layer.
2. In **Properties**, click **Effects** to show the corresponding settings.
3. In **Filter**, toggle the On/Off buttons to enable the corresponding effects (**Black and White**; **Negative**; **Sepia**; **Solar**).

14.2.12. Set layer Horizontal and Vertical flip

In  Screens / Aux.

1. Select a layer.
2. In **Properties**, click **Effects** to show the corresponding settings.
3. In **Transform**, toggle the On/Off buttons to enable the corresponding effects (**H flip** and **V flip**).

14.3. Layer transition

The transition is the animations of the layers during **Take**. Each layer can be defined by an opening and a closing transition. The opening effect is triggered when the layer switches from one source to another or when the layer appears on Screen. The closing effect is triggered if the layer is not used in the new screen.

The global transition Timing is set under the **Take** button.

Note

- Transition effect, timing and speed are not applied when using the **Take Cut** button.
- When the output rate is set to 120Hz or higher, the transitions refresh every other frame.

14.3.1. Set layer transition effect

In  Screens / Aux.

1. Select a layer.
2. In **Properties**, click **Transitions** to show the corresponding settings.
3. In **Opening**, select a transition type and transition direction.
4. In **Closing**, select a transition type and transition direction.
5. If needed, enable Cross effect and Cross depth.

Cross Effect	Seamless effect between two contents (ex: Crossfade). When disabled, the first content disappears before the next one appears.
Cross Depth	Same content changing Layer (ex: L1 to L4). The layer moves in depth to reach new z-position. When disabled, the transition is done inside the Layers. The content closes inside one layer and opens in the new layer.

 **Note**

Cross effect and Cross depth are seamless features that only apply to mixing layers.

14.3.2. Set layer transition timing

In  Screens / Aux.

1. Select a layer.
2. Set the global transition timing under the **Take** button.
3. In **Properties**, click **Timing** to show the corresponding settings.

The Opening and Closing graphs display the timings for all the layers in the selected Screen.
4. In **Opening**, enter a starting time and an ending time for the selected layer.
5. In **Closing**, enter a starting time and an ending time for the selected layer.

It is also possible to use drag and drop directly on the graphs.

14.3.3. Set layer transition speed

In  Screens / Aux.

1. Select a layer.
2. In **Properties**, click **Speed** to show the corresponding settings.
3. Toggle **Linear** to use a linear speed and hide the other settings.

If Linear is Off, the Speed curve is displayed.
4. Set the starting and ending speed to create a custom speed.

14.4. Aux Screens

Outputs used in Aux Screens can display up to 8 layers with capacity **1**.

Aux layers are dynamic, assigning a content with a capacity higher than **1** will preempt the next Aux layer(s).
One capacity needed = one layer preempted.

 **Example**

An Aux Screen is set with 6 layers. Assigning a 7860x2160 Program Screen (capacity **4**) to layer 1 will preempt layer 2, 3 and 4. Layer 5 and 6 remain available.

 **Aux layers limitations**

Aux layers support most of the same features as Screen split layers (input, image/timer, and screen program as source; size, position, crop, timings, etc.).

The Aux background layer can only support one monochrome color as a source (no input, image or background set).

Aux layers do not support:

- Seamless transitions, one content will disappear before the new one is visible.

- Alpha channels, transparent content is displayed in the same color as the background layer.
- Border settings.
- Cut & Fill effect.
- Layer freeze.

15. Memories

 **Memories** are used to save layers settings.

Master memory	Saves / loads multiple Screen memories at once (one per screen)*
Screen memory	Saves / loads the layers settings for one Screen or Aux Screen
Layer memory	Saves / loads the settings for one layer

+ More info on Master memory*

Master Memories are not loaded to Program if one of the Program Screens is locked.

The LivePremier can save up to 500 Master memories, 1000 Screen memories and 50 Layer memories. Memories can be saved from and loaded to Program or Preview Screens.

Note

Using Link Connector or 8-plug HDMI input card can modify the inputs mapping affecting previously saved Memories.



15.1. Memories tab

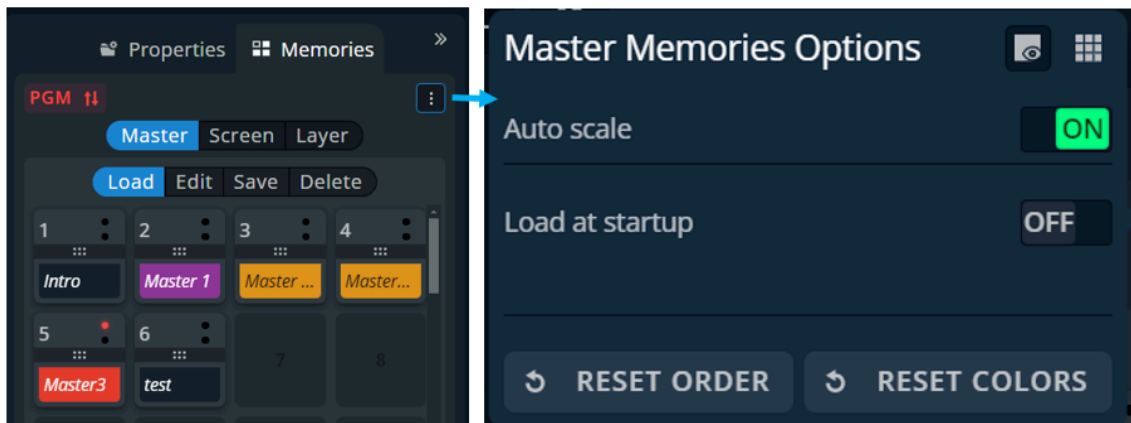

In  Screens / Aux.

 **Memories** tab is located in the right panel, next to the Properties tab.



Memories tab

Button / Setting	Description / Setting selection
	Show / hide empty Memory slots
	Toggle the number of Memory slot per column (1; 2 or 4 per column)

Auto Scale	Toggle to rescale the layers to fit the Screen(s) on load or keep the parameters as saved in the Memory
Load At Startup	(Master Memories only) Enable and select a Master memory slot to be loaded in Preview and Program Screens when starting the LivePremier unit
Reset order	Toggle to replace the memory slots in default order
Reset colors	Toggle to remove colors previously assigned to each memory
	The tallies turn red and green if the content is used in a  Program and/or  Preview Screen

15.2. Master Memories

15.2.1. Save a Master Memory from current Screens

Master Memory is the default saving mode and can be used alone as it loads settings on all Screens. A Master Memory saves the selected Screens in the current settings.

Using Filters, select which Screens, Aux, Layers and Layer settings to save in the Master Memory.

By default, all Layers and all Layer settings are selected.

A Master Memory is made of multiple Screen Memories. Saving a Master Memory saves one Screen Memory per Screen. These Screen Memories can be accessed in **Screen** mode.

Note

When a Master memory is loaded to Preview, only the Screens included in the memory are selected for Transition.

In  Screens / Aux.

1. Click the  **Memories** tab in the right panel.
2. Select **Master** mode and click **Save** to open the Save Master Memory window:

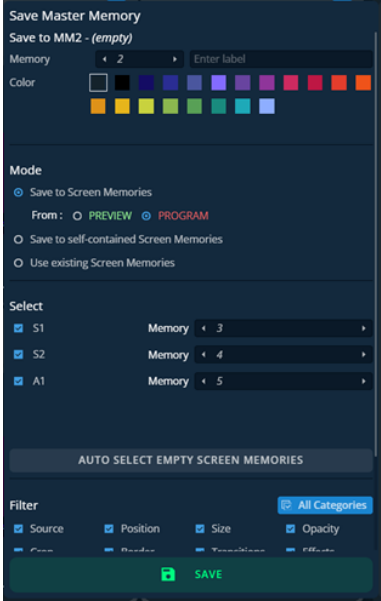
Save Master Memory view	Setting	Description / Setting selection
	Save to	Select the Master Memory slot to use Enter a label for the Master Memory Select a color for the memory slot
	Mode	Select to save the current layers settings from Program or Preview Screens with or without creating Screen/Aux Memories (self-contained mode)
	Select	Select the Screens and Aux to include/exclude from the Master Memory Select the Screen Memory slots to use in the corresponding Screens Click Auto select... to reset the choice using the first empty slots
	Filter	Select the layer settings to include/exclude from the Master Memory Select the layer to include/exclude from the Master Memory

3. Select the settings to save in the Master memory Memory using the table above.
4. Click **Save**.

 **Note**

- Selecting existing Screen Memories and Master Memories slot will overwrite them.
- Changing (and deleting) a Screen Memory also affects a Master Memory using it. If needed, create a duplicate of the Screen Memory before making changes.

 **Tip**

Use the horizontal scroll bar to display all settings of a Save Memory window.

15.2.2. Save a Master Memory from existing Screen Memories

Master Memory is made from Screen Memories therefore it is also possible to create a Master Memory by using existing Screen Memories.

In  Screens / Aux.

1. Click the  **Memories** tab in the right panel.
2. Select **Master** mode and click **Save** to open the Save Master Memory window:

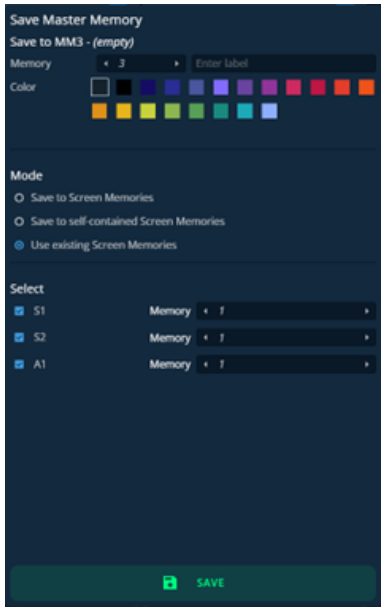
Save Master Memory view	Setting	Description / Setting selection
	Save to	Select the Master Memory slot to use Enter a label for the Master Memory Select a color for the memory slot
	Mode	Select Use existing Screen Memories
	Select	Select the Screens and Aux Screens to include/exclude from the Master Memory Select the Screen Memory slots to use in the corresponding Screens

3. Select the settings to save in the Master memory Memory using the table above.
4. Click **Save**.

Note

Changing (and deleting) a Screen Memory also affects a Master Memory using it.
If needed, create a duplicate of the Screen Memory before making changes.

15.2.3. Load a Master Memory

In  Screens / Aux.

1. Click the  **Memories** tab in the right panel.
2. Select **Master** mode, and click **Load** and click on a memory slot to load.
3. If needed, enable **Auto Scale** to adapt the loaded memories to fit the Screens.
4. Click a layer in Program or Preview.
5. Click a Master Memory slot.

The Master Memory is loaded to Program or Preview in the Screens selected in the Master Memory.

The Screens selected in the Master Memory are enabled for transition in the Screen selection filter.

Option

It is also possible to drag a memory slot to a Program or Preview Screen.



15.2.4. Load a Master Memory at startup

Load a user defined Master Memory on Program and Preview when turning the LivePremier device on.

Note

Master Memory load at startup does not support Auto-scale. Use Screen Memories that match the Screen size in the Master Memory to load at startup.

In  Screens / Aux.

1. Click the  **Memories** tab in the right panel and click .
2. Enable **Load At Startup** and select **Last known state** or a Master Memory slot to load at startup.
3. Toggle **Load At Startup** to disable the feature.

15.2.5. Edit a Master Memory

1. Load a Master Memory.
2. Click **Save** to open the Master Memory saving window.
3. Select the settings to save.
4. Select the existing Master Memory slot to edit.
5. Click **Save** to overwrite the previous Master Memory.

15.3. Screen Memories

15.3.1. Save a Screen Memory

A Screen Memory saves the selected Screen in the current settings.

Using Filters, select which Layers and Layer settings to save in the Screen Memory. By default, all Layers and all Layer settings are selected.

In  Screens / Aux.

1. Click the  **Memories** tab in the right panel.
2. Select **Screen** mode.

3. Click **Save** to open the Save Screen Memory window:

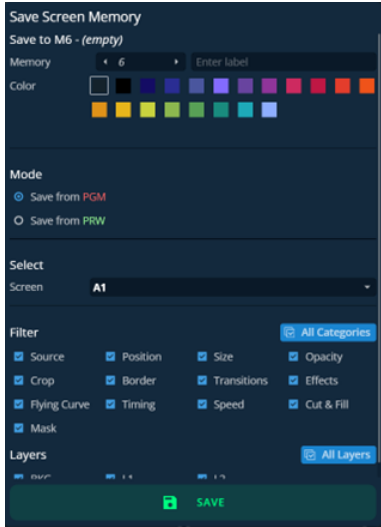

Save Screen Memory view	Setting	Description / Setting selection
	Save to	Select the Screen Memory slot to use Enter a label for the Screen Memory Select a color for the memory slot
	Mode	Select to save the current layers settings from Program or Preview Screen
	Select	Select the Screen to save
	Filter	Select the layer settings to include/exclude from the Screen Memory Select the layer to include/exclude from the Screen Memory

4. Select the settings to save in the Screen Memory using the table above.

5. Click **Save**.

15.3.2. Load a Screen Memory

In  Screens / Aux.

1. Click the  **Memories** tab in the right panel.
2. Select **Screen** mode, click **Load** and click on a memory slot to load click **Load**.
3. If needed, enable **Auto Scale** to adapt the loaded memory to fit the Screen.
4. Use the  buttons or Screen transition filter to select the Screen(s).

The Screens selected for Screen Memory loading are also indicated under the  **Memories** tab:

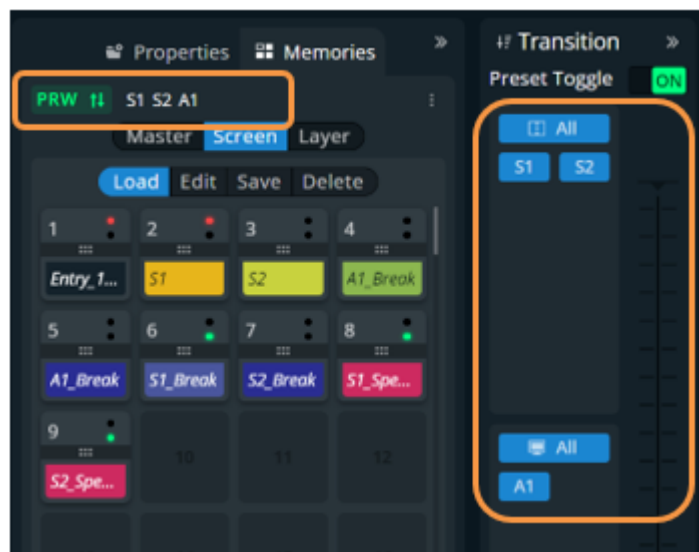

5. Click a Screen Memory slot.

The Screen Memory is loaded to all Screens selected for transition in Program or Preview.

Tip

To affect a Screen Memory to only one Screen, it is also possible to drag a memory slot to a Program or Preview Screen.

15.3.3. Edit a Screen Memory

1. Load a Screen Memory.
2. Click **Save** to open the Screen Memory saving window.
3. Select the settings to save.
4. Select the existing Screen Memory slot to edit.
5. Click **Save** to overwrite the previous Screen Memory.

15.3.4. Quick overwrite or revert

When a Screen Memory is loaded in a Screen, a button with the memory slot number appears. If changes are made to the Screen, a * appears next to the memory slot number.

1. Click the memory button to show more options.
2. Click **Save** to overwrite the Screen Memory with the new layer settings.
Or
Click **Revert** to reload the Screen Memory.

15.4. Layer Memories

15.4.1. Save a Layer Memory

A Layer Memory saves the selected Layer in the current settings.

Using Filters, select which Layer settings to save in the Layer Memory. By default, all Layer settings are selected.

Note

- If multiple layers are selected, the memory saves the layer settings of the Reference Layer. The Reference Layer is the first layer selected; it is indicated in the Properties tab.
- Master memories and Screen memories cannot point to Layer memories.

In  Screens / Aux.

1. Click the  **Memories** tab in the right panel.
2. Select **Layer** mode and click **Save** to open the Save Layer Memory window:

Save LayerMemory view	Setting	Description / Setting selection
	Save to	Select the Layer Memory slot to use Enter a label for the Layer Memory Select a color for the memory slot
	Select	Shows the selected layer
	Filter	Select the layer settings to include/exclude from the Layer Memory

3. Select the settings to save in the Layer Memory using the table above.
4. Click **Save**.

15.4.2. Load a Layer Memory

In  Screens / Aux.

1. Click the  **Memories** tab in the right panel.
2. Select **Layer** mode, click **Load** and click on a memory slot to load.
3. If needed, enable **Auto Scale** to adapt the loaded memory to fit the Screen.
4. Click a layer in Program or Preview.
5. Click a Layer Memory slot.

The Layer Memory is loaded to the selected Layer in Program or Preview.

Option

It is also possible to drag a memory slot to a Program or Preview Layer.



15.4.3. Edit a Layer Memory

1. Load a Layer Memory.
2. Click **Save** to open the Layer Memory saving window.
3. Select the settings to save.
4. Select the existing Layer Memory slot to edit.

5. Click **Save** to overwrite the previous Layer Memory.



15.5. Rename a Memory

In  Screens / Aux.

1. Click the  **Memories** tab in the right panel.
2. Select **Master**, **Screen** or **Layer** mode.
3. Click **Edit**.
4. Click  in the top right corner of the memory slot to open the **Label** and **Color** fields.
5. Enter a new name for the memory slot.

15.6. Change the color of a Memory slot

In  Screens / Aux.

1. Click the  **Memories** tab in the right panel.
2. Click **Edit**.
3. Click  in the top right corner of the memory slot to open the **Label** and **Color** fields.
4. Select a color for the memory slot.

Tip

To reset all memory slots to default colors, click  on top of the memory slots and click **Reset colors**.

15.7. Reorder Memories

In  Screens / Aux.

1. Click the  **Memories** tab in the right panel.
2. Select **Master**, **Screen** or **Layer** mode.
3. Click **Edit**.
4. Drag a memory slot to a new place to organize the memory slots in a custom order.

Note

- Reordering memory slots does not change the memory slot number and does not impact external controllers and RC400T.
- Reordering Screen Memories does not impact Master Memories.

Tip

To reset to default order, click  on top of the memory slots and click **Reset order**.

15.8. Delete a Memory

In  Screens / Aux.

1. Click the  **Memories** tab in the right panel.
2. Select **Master**, **Screen** or **Layer** mode.
3. Click **Delete**.
4. Select one or multiple memory slots to delete.
5. Click **Delete** at the bottom of the slots.

16. Multiviewers

Prerequisite

Go to  **Multiviewers** after all pre-configurations are set.

This menu displays one or two Multiviewers screens, depending on what is set in Preconfig > Multiviewers.

Set:

- Multiviewers layout
- Widgets.

A Multiviewer is an output displaying a user customizable selection of Widgets as display resources.

A Widget works like a layer and can display a program, preview, input, image or timer. One Multiviewer can display up to 64 Widgets.

More options

Go to Setup  **Multiviewers** to set the Label, Signal parameters, Patterns and Image correction.

16.1. Tips and recommendations

- Widgets cannot be placed on top of each other (overlap error).
- The same source cannot be used in more than one widget per Multiviewer.
- Two widgets using the same source in both Multiviewers are displayed at the same resolution (smallest widget).

16.2. Multiviewers menu interface

The menu  **Multiviewers** behaves much like the menu  **Screens**:

- Sources on the left panel: Inputs, Images, Timers and Screens.
- Widget letter icons and Bottom bar icons.
- Widget properties and Memories on the right panel.
- Collapsible side menus and screen area zoom.

Note

- There are no transition or Program/Preview features in Multiviewers.
- Orange FX (Effect) sign at the bottom of a widget indicates **Take** in progress.

16.2.1. Sources - Left panel

The Sources are located in the left panel. Click the icons to show the corresponding sources:



Note

Widgets can display Program and Preview for Screens and Program only for Aux Screens.

The following information are displayed per source content:

- Source number
- Source label
- Source capacity
- Resolution
- The tallies turn red and green if the content is used in a

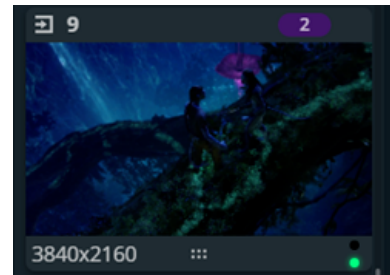

● **Program** and/or ● **Preview** Screen.

Options

On hover, click  in the bottom-right corner of a source thumbnail to open options (ex: Freeze an input, access the setup menu for the selected source or select an NDI source, if available).



Tip

- Use the search bar at the bottom of the Sources panel to find a source or to display a batch of sources with the same char in the label.
- Click on the icon next to the search bar to downsize or expand the sources snapshots.

16.2.1.1. Control counter timers in Multiviewers

It is possible to run, pause and stop the counters directly in the source panel in Live > Multiviewers.

In  **Multiviewers**

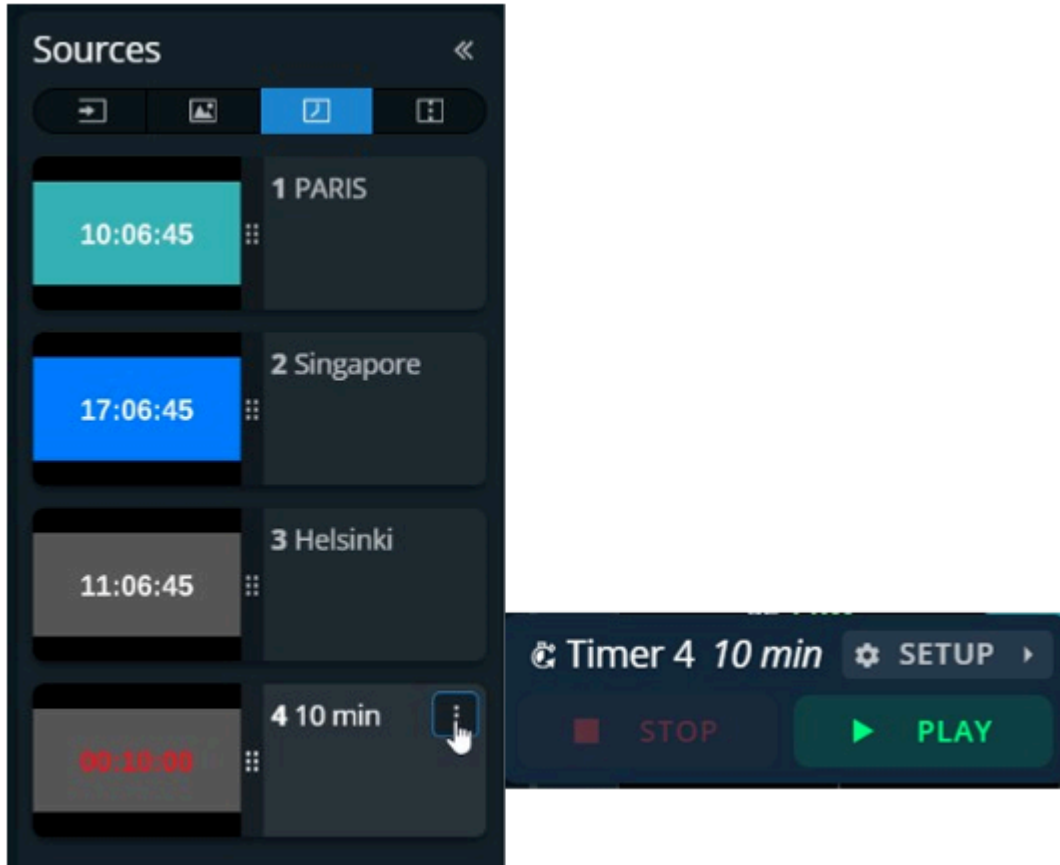

1. Click  Timers in the source panel.
 2. Hover over a timer and click  to show control options.
 3. Click Setup to enter timer settings.
- Or
- Use the buttons to run, pause and stop the counter.



Timer controls in Multiviewer

16.2.1.2. Set Preview mode for Preview Screen widgets

In  Multiviewers

1. Click  Screens in the source panel.
2. Hover a Preview Screen and click  to show preview options:

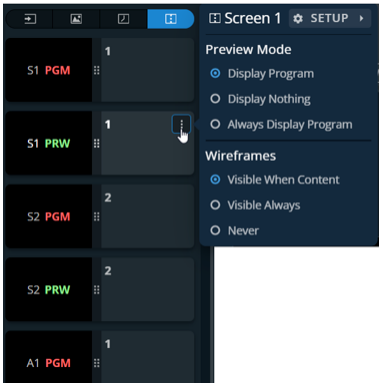





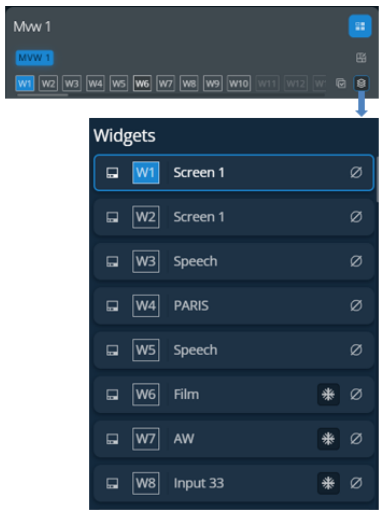

Preview Screen	Setting	Description / Setting selection
	Preview Mode	Select what is displayed in the Preview widget: <ul style="list-style-type: none"> - Display Program during transitions - Display Nothing during transitions - Always Display Program content in the Preview widget
	Wireframes	Select the visibility of the wireframes of the Preview Screen layers: <ul style="list-style-type: none"> - Layers wireframes displayed when content - Layers wireframes are always displayed - Layers wireframes are never displayed

Tip

It is possible to monitor both Program and Preview of a Screen in one Widget by using Always Display Program content and display Preview layers wireframe.

16.2.2. Widget selection

This bar shows tools and all available layers for the corresponding Screen.

Widget selection	Setting	Description / Setting selection
		Select the Multiviewer for Memory load or <i>Select all widgets</i> button in bottom bar
		Open the layout editor, see Multiviewer layout editor [p.170]
		Open a detailed view of all widgets in the selected Multiviewer (source number) - Click  to empty the widget content and keep other properties - Click  to freeze input
		Select all widgets in this Multiviewer
		Deselect all widgets in this Multiviewer

Tip









- Hold **Ctrl** or **Shift** to select multiple widgets.
- Scroll the slide bar under the Widget letters to access the widgets that are not displayed.

16.2.3. Multiviewer layout editor

Click  to open the layout editor, a smart tool to place widget in the Multiviewers easily.

Layout editor	Setting	Description / Setting selection
	Columns & Rows	Create a custom grid
	Margin	Reduce the area of this layout (ex: Top: 50% will ignore the top half of the Multiviewer)
	Spacing	Set gaps between columns and/or rows
	Autofill	Select the source content to put in layers
	Widgets	Select widgets to include/exclude from this layout

16.2.4. Bottom bar buttons

Button	Button description
Action buttons	
	Select all widgets in the selected Multiviewers (indicated on the left side)
	Deselect all widgets
	Empty the widgets content and keep other properties for the selected widgets
Assist buttons (On/Off toggle buttons)	
	Snap to Multiviewer border and other widgets borders
	Snap to grid cells Click the arrow to set the grid (columns and rows)
	Keep aspect ratio
Interface buttons (On/Off toggle buttons)	
	Hide empty and preempted items (layers and sources)
	Hide content to display only widgets wireframe

16.3. Widget properties

When a widget is selected, the following widget settings are available in the Properties tab:

Setting	Description / Setting selection
View	Enable: Toggle to show/hide the widget OSD (On Screen Display): - Off: Hide OSD information - Basic: Only show the title of the source in widget OSD - Detailed: Show full OSD information on the widget
Source	Select a content for this widget
Position/Size	Set widget Vertical and Horizontal position in pixels Set widget Height and Width in pixels

16.3.1. Widget position and size

16.3.1.1. Set widget position with the layout editor

Layouts are predefined templates arranging widgets automatically in one Multiviewer.

In  **Multiviewers**

1. Click  in the selected Multiviewer to open the layout editor.
2. Create a custom layout in Mosaic or Cascade mode.
3. Auto-fill the widgets with a type of source.
4. Select widgets to include/exclude from the layout.
5. Apply the layout on Multiviewer.

All the Multiviewer widgets are arranged automatically.

More information

See  Multiviewer layout editor ^[p.170].

16.3.1.2. Set widget position and size manually

The maximum display size for sources in Multiviewers is their 1:1 format. They can be resized to fit smaller widgets.

In  **Multiviewers**

1. Select a widget.
The selected widget is highlighted.
2. Use drag and drop on the widget to move it in the Screen.
3. Use drag and drop on a widget border point to change its size.

OPTION

It is also possible to use the Properties panel:

1. Go to Properties, click **Position** and **Size** to show the corresponding settings.
2. Set the Position and Size by entering values or using drag and drop.

TIP

- In the **Size** property, click  to keep the aspect ratio when changing the size values.
- Use bottom bar buttons (Keep aspect ratio, snap to items) to have widgets of equal size or alignment. When enabling snap to item, widgets borders are automatically attracted to other objects (Multiviewer border, widget border, grid snap point) to match their position or size.

16.3.1.3. 2x2 Slicer mode with DPH104

When using a Multiviewer output in 2x2 Slicer mode with a DPH104, the signal is automatically divided in 2x2 following the selected format.

TIP

Use the layout editor to make sure the widgets are placed in their corresponding $\frac{1}{4}$ of the Screen.

16.3.2. Widget source - Assign content to a widget

In  **Multiviewers**

1. Click a source icon in the left panel.

To change NDI stream, click on  in any NDI input thumbnail to update the list of NDI sources, select a stream and adjust the buffer size.
2. Select a widget or make sure it is available for drag and drop.
3. Drag a content to the widget.

The content thumbnail is displayed in the widget with the source label at the bottom.

Other ways to assign a content

- Drag and drop the selected content into the widget letter icon on the top of each Multiviewer.
- Select a widget then go to Properties > Source and select the content in the drop-down list.

16.4. Multiviewers memories

A Multiviewer memory saves the selected Multiviewer in the current settings. All widgets' settings are saved/loaded. The LivePremier can save up to 50 Multiviewer memories.



16.4.1. Save a Multiviewer memory

In  **Multiviewers**

1. Click the  **Memories** tab in the right panel.
2. Click **Save** to open the Save Multiviewer Memory window.
3. Select the Multiviewer to save.
4. Select the memory slot and enter a label.
5. Select a color for the memory slot.
6. Click **Save**.

16.4.2. Load a Multiviewer memory

In  **Multiviewers**

1. Click the  **Memories** tab in the right panel.
2. Click **Load**.
3. If needed, click on  to enable **Auto Scale** to adapt the loaded memory to fit the Multiviewer.
4. Click on a Multiviewer(s) to select one (or both).
5. Click a Multiviewer memory slot.

The Multiviewer memory is loaded to the selected Multiviewer.



Option

It is also possible to drag a memory slot to a Multiviewer.

16.4.3. Load a Multiviewer memory at startup

Load a user defined Multiviewer memory when turning the LivePremier device on.

In  **Multiviewers**

1. Click the  **Memories** tab in the right panel and click .
2. Enable **Load At Startup** and select a Multiviewer memory slot to load at startup for each Multiviewer output.
3. Toggle **Load At Startup** to disable the feature.



16.4.4. Edit a Multiviewer memory

1. Load a Multiviewer memory.
2. Click **Save** to open the memory saving window.
3. Select the Multiviewer to save.
4. Select the existing Multiviewer memory slot to edit.

5. Click **Save** to overwrite the previous Multiviewer memory.



16.4.5. Rename a Memory

In  **Multiviewers**

1. Click the  **Memories** tab in the right panel.
2. Click **Edit**.
3. Click  in the top right corner of the memory slot to open the **Label** and **Color** fields.
4. Enter a new name for the memory slot.

16.4.6. Change the color of a Memory slot

In  **Multiviewers**

1. Click the  **Memories** tab in the right panel.
2. Click **Edit**.
3. Click  in the top right corner of the memory slot to open the **Label** and **Color** fields.
4. Select a color for the memory slot.

Tip

To reset all memory slots to default colors, click  on top of the memory slots and click **Reset colors**.

16.4.7. Reorder memories

In  **Multiviewers**

1. Click the  **Memories** tab in the right panel.
2. Click **Edit**.
3. Drag a memory slot to a new place to organize the memory slots in a custom order.

Note

Reordering memory slots does not change the memory slot number and does not impact external controllers and RC400T.

Tip

To reset to default order, click  on top of the memory slots and click **Reset order**.

17. User Maintenance and Troubleshooting

17.1. User Maintenance – Air filter

The LivePremier unit is equipped with a removable air filter at the front of the unit.

Tip

For optimal performance, this air filter must be cleaned by the user regularly (once a year).

Tools

- Torx T20 screwdriver
- duster or vacuum

1. Turn the unit off and unplug the mains.
2. Remove the four screws on the front panel.
3. Using both hands, gently pull the front panel on a straight axis.
4. Gently tilt it down until mechanical stop.
The front panel is in a safe still position.
5. Pull the air filter and take it out from the unit.
6. Carefully clean the air filter with a duster or vacuum.
7. When the air filter is clean, gently put it back in place.
8. Gently tilt up the front panel until it is aligned.
9. Gently push the front panel back in place on a straight axis.
10. Set the screws back in place.
The unit is now ready for use

17.2. Troubleshooting

The Web browser cannot access the Web RCS

- Make sure to use correct network cables and that they are free from defects.
- Check the IP address of the control computer. It must have a unique IP address on the same network as the LivePremier unit.
- Temporarily disable any other networks on the computer, such as turning off the Wi-Fi connection.
- Refresh the browser.
- Close and restart the browser.

 **Error: timeout of 20000ms exceeded**

- Check that the anti-virus is not blocking the connection. Open your anti-virus program and add the IP address of your units as trusted connection.

 **Modifications triggered from RC400T do not work when synchronized**

- Check that the target Preview and Program Screens are not protected by lock.

18. Appendix: RC400T

The **RC400T** event controller has been designed to instantly access the crucial functionalities of the LivePremier image processor such as screens, layers, sources and memories. The RC400T offers 56 user programmable buttons, a high-resolution T-bar and a three-axis joystick for easy and fast programming (assign source in layers, load memories, etc.). The RC400T can work with the Web RCS at the same time as both selections are synchronized.

Option

It is possible to display and operate an RC400T directly from Web RCS (Live menu), see  Virtual RC400T [p.190].

Caution

The fuse(s) present in the unit have not been designed to be replaceable. In case of problem, contact Analog Way support.

18.1. Installation

The RC400T has been designed to be used directly on a table. It is equipped with a wrist rest and four anti-slip rubber feet. The wrist rest can be removed for a recessed installation of the RC400T.

Recessed installation - Remove the wrist rest

1. Turn the rear panel power switch off and disconnect the power supply.
2. Remove the screws of the wrist rest on both sides of the RC400T using a T10 Torx screwdriver.
3. Safely remove the wrist rest.

The RC400T is ready for recess installation. Before embedding the RC400T, connect all cables and turn the rear panel power switch on or make sure they can be accessed.

RC400T dimensions: L 570 mm x H 122.5 mm x P 382 mm (W 22.44" x H 4.82" x D 15.04").

18.2. Controller description



1. Top area

This area is used mainly for configuring the RC400T (status, network, upgrade, factory reset, etc.). It is composed of:

- a Power button
- an LCD display
- a rotary encoder
- two LED keys (**Confirm** and **Cancel**).

Tip

Use the rotary encoder to move the selection and use the buttons to Confirm / Cancel the choices.

XLR lamp (optional)

The XLR lamp is used to light the RC400T if needed.

To turn the lamp on, go to **front panel settings** and enable **Power on light**.

For more information on the XLR lamp for RC400T visit our website <https://www.analogway.com>.

2. Program/Preview key

Press the Program/Preview key to toggle between Program and Preview modes.

- **Program** mode is enabled when the key is on with a **red light**.
- **Preview** mode is enabled when the key is off.

Note

The **Program/Preview** key affects the entire Selection area.

3. Selection area - Multi-purpose area

The Selection area is used for Screen composition. Select Screens, Aux Screens, Layers, and assign Sources or reload Memories. The Selection area is composed of 4 identical rows of keys. Each row is composed of 12 LED keys with labels in OLED displays, one LCD key and one rotary encoder. Each row can display a predefined group of items depending on the mode selected by the user.

4. User keys area and Joystick

The User keys area is composed of 8 LED keys, one OLED display, one LCD key and one rotary encoder. This area has been designed to be evolutive and user customizable. The user keys are predefined slots for features or actions set by the user (lock/unlock a screen, remove a source content, set transition time, disable the T-bar, etc.).

The Joystick is used to adjust the crop, size and position of one layer. It is used together with the user keys.

5. Transition area

The Transition area is composed of one T-bar and 3 LED keys: **Take Cut**, **Step Back** and **TAKE**:

- **Take Cut** triggers an immediate transition from Preview to Program without effects or duration.
- **Step Back** reloads the former Program to the Preview.
- **TAKE** triggers the transition from Preview to Program with effects, duration, etc.

The T-bar is a manual Take triggered by the user for a smooth transition.

Note

The transition applies only to Screens selected in the Selection area.

6. RC400T rear panel



RC400T - rear panel

The rear panel is composed of:

- One power plug with a switch button
- One Ethernet plug for network connection
- One HDMI plug
- One USB plug.

18.3. Getting started

Note

- In the Web RCS, in Dashboard > Remote Control, make sure the connection with RC400T is enabled.
- Make sure that ports 80, 443, 10591, 10606, 10691, 10692 and 10693 are available on your network and/or not blocked by firewall

18.3.1. Start the RC400T

The RC400T controls LivePremier devices using standard Ethernet LAN networking.

1. Connect the power supply cord on the rear panel.
2. Connect the RC400T to the same network as the LivePremier unit.
3. Turn the RC400T on (rear and front On/Off buttons).

18.3.2. Turn the RC400T off

Press the On/Off button on the front panel and confirm to turn the RC400T off.

18.3.3. Configure the RC400T network

1. On the front panel, go to **Remote Device Network > Remote device LAN settings**.
2. Select a device slot, set the IP address of the LivePremier unit and Apply (192.168.2.140 by default).
3. If needed, repeat in the other device slots to add more connected units.
4. If needed, go to **Console Network**, set the IP address of the RC400T and Apply (192.168.2.130 by default).

The connection status is displayed on screen.

If the connection is not starting:

- Check that both IP addresses are on the same network and subnet.
- Check that no device has the same IP address (prevent IP conflicts).
- Check that all network configurations have been applied.
- Check that the LivePremier unit and RC400T have the latest firmware version installed.
- Check the network cables for the RC400T and a hub or switch (if involved).

18.3.4. Control multiple units with the RC400T

When multiple LivePremier units are enabled for remote control, the **RC400T** displays a new home page to select the device to use (by default, the active unit is the one configured in the first device slot).

- Press the **Exit/Menu** button on the Setting page to display the device selection page.

 **Note**

- An RC400T can be connected to up to four LivePremier units (only one at a time is enabled).
- A LivePremier unit can be connected to up to three RC400T controllers.

18.3.5. Firmware upgrade

 **Prerequisite**

Download the RC400T updater on www.analogway.com [http://www.analogway.com/].

1. Put the updater file on a USB drive.
2. Connect the USB drive on the front panel.
3. The updater file is automatically detected. Otherwise, go to **Console Control > Update from USB**.
4. Extract the updater file.
5. Install the new firmware.

 **Recommendation**

Update the LivePremier unit with the latest firmware.

18.3.6. Reset to default values

1. On the front panel, go to **Console Control > Reset to default values**.
2. Confirm to reset the device to default values.

18.3.7. Enable / Disable the T-bar

The T-bar status is displayed in the corresponding display. The T-bar can be disabled if needed.

- On the **User keys area**, press the **T-bar Enable** key to enable / disable the T-bar.

18.4. LivePremier control with RC400T

18.4.1. Lock / Unlock the screen

To apply any modifications to the program screen it must be unlocked first.

- On the **User keys area**, press the **Lock / Unlock** key to apply the action to the current (PGM or PRW) selection.

18.4.2. Select a row mode

1. On the **Selection area**, press the LCD key of a row. The row is on Mode selection and the available modes are displayed in the OLED screens.
2. Select a mode using the corresponding LED key. The row is now in the selected mode.
3. Use the rotary encoder to change the page if needed.

 **Note**

The same mode can be selected in different rows.

 **Examples of configurations**

Loading Master memories (default view):

- Row 1: Screens / Aux Screens
- Row 2: Master memories 1 to 12 (page 1)
- Row 3: Master memories 13 to 24 (page 2)
- Row 4: Master memories 25 to 36 (page 3)

Assigning inputs to layers:

- Row 1: Screens / Aux Screens
- Row 2: Layers or Scr./Aux. Layers
- Row 3: Inputs 1 to 12 (page 1)
- Row 4: Inputs 13 to 24 (page 2)

18.4.3. Layer selection

The RC400T has two modes for selecting layers.

Layers	Shows all available live layers in the selected Screens as BKG Layer, Layer 1, Layer 2 , etc. This mode allows quick selection of the same layer in multiple screens. It is recommended when programming shows with lots of Screens and Layers.
Scr./Aux. Layers	Shows all available live layers in the selected Screens as S1.BKG, S1.L1, S1.L2 , etc. This mode allows selecting a single layer when multiple Screens are selected. It is recommended when programming shows with less than 36 layers in total.

 **Note**

It is only possible to select a layer when the corresponding Screen or Aux is selected, even when using Scr./Aux. Layers mode.

 **Select one or multiple layer**

Some of the following procedures will require one or multiple layers to be selected.

1. On the **Selection area**, press the LCD key of a row. The row is on Mode selection.
2. Select the **Screens & Aux.** mode using the corresponding LED key. The row is in Screen mode.

3. Select the Screen using the corresponding LED key.
4. On another row, press the LCD key and select the **Layers** mode.
5. Select one or multiple layers. Use the rotary encoder to change the page if needed.

OR

1. On the **Selection area**, press the LCD key of a row. The row is on Mode selection.
2. Select the **Scr./Aux. Layers** mode using the corresponding LED key.
3. Select one or multiple layers. Use the rotary encoder to change the page if needed.

18.4.4. Assign a source to a layer

1. Select the Program or Preview mode.
2. Select one or multiple layers.
3. On another row, press the LCD key and select a source (BKG sets, Inputs or Images).
4. Select a source. Use the rotary encoder to change the page if needed.

The source is now assigned to the selected layers in the selected Screen.

Tip

- When Background and Live layers are selected at the same time, a new source is affected only if the layer is compatible (ex: BG set to BKG layer), otherwise the source stays the same.
- When multiple live layers are selected:
 - If they use the same source content, the key of the source in use is On with a solid orange color



- If they use different contents, the key(s) of the source(s) in use is On with a solid yellow color



More information

See  Button color guide ^[p.188].

18.4.5. Remove a source from a layer

1. Select the Program or Preview mode.
2. Select one or multiple layers.
3. On the **User keys area**, press the **Source None** key.

The selected layers are cleared from any source.

18.4.6. Set a layer position and size

Note

This is only applicable to one layer. If multiple layers are selected, changes will only be applied to the layer leader (first selected).

1. Select the Program or Preview mode.
2. Select one layer.
3. On the **User keys area**, press the **Layer Pos/Size** key.

The selected layer is indicated on the display.

- Rotate the joystick clockwise or counterclockwise to resize the layer while keeping the aspect ratio.
 - For fine adjustment, press a key to select a setting (**Pos X**, **Pos Y**, **Width** or **Height**), then use the rotary encoder.
 - Push the joystick to move the layer.
4. Use the **Back** key to quit the Layer Pos/Size menu.

Tip

To change the default anchor point for position and size adjustments, select **Params > Layer Pos/Size > Anchor** and choose the corresponding value(s).

18.4.7. Set a layer crop

Note

This is only applicable to one layer. If multiple layers are selected, changes will only be applied to the layer leader (first selected).

1. Select the Program or Preview mode.
2. Select one layer.
3. On the **User keys area**, press the **Layer Crop** key.

The selected layer is indicated on the display.

- Rotate the joystick clockwise or counterclockwise to crop the layer equally on all sides.
 - For fine adjustment, press a key to select a side (**Top**, **Left**, **Bottom** or **Right**), then use the rotary encoder.
 - Push the joystick to move the crop area.
4. If needed, use the **Reset Crop** key to reset the layer crop.
 5. Use the **Back** key to quit the Layer Crop menu.

18.4.8. Set an input crop

Note

Input crop replaces the input content and affects every layer using it. If needed, use layer crop or duplicate the input with a splitter.

1. On the **Selection area**, press the LCD key of a row. The row is on Mode selection.
2. Select one layer.
3. Assign an input to this layer.
4. On the **User keys area**, press the **Input Crop** key.

The selected layer is indicated on the display.

- Rotate the joystick clockwise or counterclockwise to crop the input equally on all sides.
 - For fine adjustment, press a key to select a side (**Top**, **Left**, **Bottom** or **Right**), then use the rotary encoder.
 - Push the joystick to move the crop area.
5. If needed, use the **Reset Crop** key to reset the input crop.
 6. Use the **Back** key to quit the Input Crop menu.

18.4.9. Load a Layer memory

1. Select the Program or Preview mode.
2. Select one or multiple layers.
3. On another row, press the LCD key and select a **Layer Memories**.
4. Select a memory. Use the rotary encoder to change the page if needed.

The Layer memory is now loaded to the selected Screen.

18.4.10. Load a Screen memory

1. Select the Program or Preview mode.
2. On the **Selection area**, press the LCD key of a row. The row is on Mode selection.
3. Select the **Screens & Aux.** mode using the corresponding LED key. The row is on Screen mode.
4. Select the Screen using the corresponding LED key.
5. On another row, select the **Screen Memories** mode.
6. Select a memory. Use the rotary encoder to change the page if needed.

The Screen memory is now loaded to the selected Screen.

18.4.11. Load a Master memory

1. Select the Program or Preview mode.
2. On the **Selection area**, select the **Master Memories** mode.
3. Select a memory. Use the rotary encoder to change the page if needed.
The Master memory is now loaded to Screens as set in the Master memory.

18.4.12. Screen selection for Transitions

After loading a memory in Preview, select / deselect the Screens to transition.

1. On the **Selection area**, select the **Screens & Aux.** mode.
2. Select the Screens to transition.
*To select all Screens, press the **Select Scrs&Auxs** key on the User keys area.*
3. On the **User keys area**, press the **Take duration** key and use the rotary encoder to set the transition time.
4. On the **Transition area**, trigger the transition.
The selected Preview Screens are sent to Program.

18.4.13. Load a Multiviewer memory

1. On the **Selection area**, press the LCD key of a row. The row is on Mode selection.
2. Select the **Multiviewers** mode using the corresponding LED key. The row is on Multiviewers mode.
3. Select the Multiviewer output using the corresponding LED key.
4. On another row, select the **Mvw Memories** mode.
5. Select a memory. Use the rotary encoder to change the page if needed.
The Multiviewer memory is now loaded to the selected Multiviewer.

18.4.14. Save a Master Memory

Note

Saving Master Memories from the RC400T will always include all Screens, all layers and all layer properties.

1. Select the Program or Preview mode to save the corresponding Screens.
2. On the **User keys area**, press the **Memories** key.
3. Press the **Master Memories** key.
4. Use the rotary encoder to select a memory slot.
5. Press **Save**.
The Master Memory is now saved.

18.4.15. Save a Screen Memory

Note

Saving Screen Memories from the RC400T will always include all layers and all layer properties.

1. Select the Program or Preview mode to save the corresponding selection.
2. On the **Selection area**, select one Screen to save.
3. On the **User keys area**, press the **Memories** key.
4. Press the **Screen Memories** key.
5. Use the rotary encoder to select a memory slot.
6. Press **Save**.

The Screen Memory is now saved.

18.4.16. Save a Layer Memory

Note

Saving Layer Memories from the RC400T will always include all layer properties.

1. Select the Program or Preview mode to save the corresponding selection.
2. On the **Selection area**, select one Layer to save.
3. On the **User keys area**, press the **Memories** key.
4. Press the **Layer Memories** key.
5. Use the rotary encoder to select a memory slot.
6. Press **Save**.











The Layer Memory is now saved.

18.4.17. Delete a memory

1. On the **User keys area**, press the **Memories** key.
2. Press the **Master, Screen or Layer Memories** key.
3. Use the rotary encoder to select a memory slot.
4. Press the **Delete** key to delete a memory.

18.4.18. Button color guide

Button color	Description
SELECTION	
 Solid green	<ul style="list-style-type: none"> • Item available and not selected

 Solid orange	<ul style="list-style-type: none"> • Screen, Aux or Multiviewer element is selected for edition and for transition • Master Memory is currently loaded • Screen Memory is loaded in all selected Screens • Layer Memory is loaded in all selected Layers • Layer is selected in all the selected Screens • Source is currently used in all the selected Layers • BKG set is currently used in the all the selected Screens
 Solid yellow	<ul style="list-style-type: none"> • Screen Memory is loaded in some of the selected Screens • Layer Memory is loaded in some of the selected Layers • Layer is selected in some of the selected Screens • Source element is currently used in some of the selected Layers • BKG set is currently used in some of the selected Screens • Some of the selected screens are locked
 Blinking yellow	<ul style="list-style-type: none"> • Row waiting for Mode Selection • Set transition duration
 Button Off	<ul style="list-style-type: none"> • Item not available
USER KEYS	
 Solid green	<ul style="list-style-type: none"> • Function available and not selected
 Solid orange	<ul style="list-style-type: none"> • Function enabled or ready for edition
 Solid red	<ul style="list-style-type: none"> • Program mode is active
 Button Off	<ul style="list-style-type: none"> • Preview mode is active • No function or submenu
TRANSITION	
 Solid green	<ul style="list-style-type: none"> • Step back is available
 Solid red	<ul style="list-style-type: none"> • Take is available
 Blinking red	<ul style="list-style-type: none"> • Take in progress

18.4.19. Virtual RC400T

The LivePremier Virtual RC400T behaves like a physical console.

It can be used independently or mirror up to three connected RC400T.

- To mirror the connected RC400T, select the port number corresponding to a physical console.

Tip

Use arrow keys instead of rotary decoder to move pages or change values.

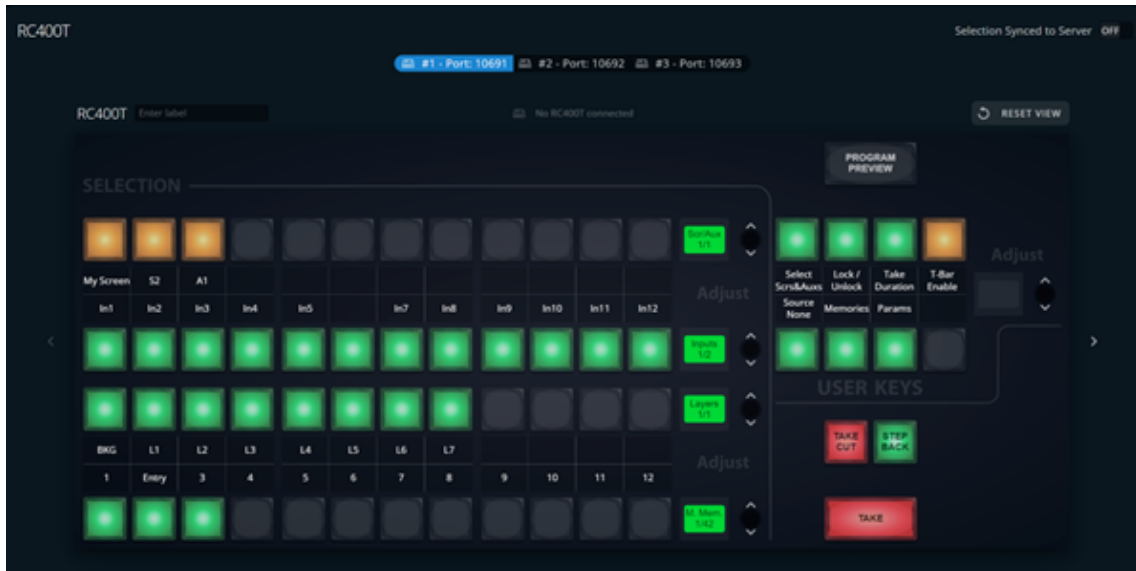

Virtual RC400T

19. Appendix: Other LivePremier control options

LivePremier units are also compatible with the Analog Way **Shot Box²** and **Control Box³** and also with **Companion** or **Universe** installed on a Stream deck.



Shot Box²



Control Box³



Stream deck + Companion or Universe

19.1. Use the Shot Box² and Control Box³ with LivePremier

Analog Way Shot Box² and Control Box³ can be used to recall Memories and trigger transitions.

Tip

With the software **AW Shotbox Control**, Shot Box² and Control Box³ can also be used when connected to a computer on the same network as the LivePremier™ device.

Note

- In the Web RCS, in Dashboard > Remote Control, make sure the connection with External USB Controllers is enabled.
- The Control Box³ (SB124T-3) has been designed specifically for the latest Analog Way product lines. The previous version, Control Box² (SB124T-2 designed for LiveCore products) is still compatible but some features are limited or not supported.

To use these controllers:

1. Connect the controller directly to the LivePremier unit via USB ports.
2. On the unit front panel, go to Control > Controller.

The reference of the controller is indicated.

The tallies indicate the connection status (● = OK; ● = Connecting; ● = No Connection)

3. Enable Identify to display ID on the controller (1 to 4).
4. Select the controller to open its settings:

Controller setting	Description
Enable	Enable or disable the controller
Backlight	Set the keyboard brightness (in %)

Mode*	Choose to recall Screen Memories or Master Memories
Screen*	Choose the Screen
Destination*	Choose to interact with Program or Preview
Autoscale	Enable to rescale Memory to applied Screen canvas size
Take on load	Enable to automatically trigger the transition when loading a Memory on Preview
Reset	Reset the controller configuration

* *only available with the ShotBox²*

5. Use the keys of the controller to recall Memories and trigger transitions.

19.2. Use the Stream deck with LivePremier

Companion and Universe are software that transform the Elgato Stream deck into a shot box that can be used with LivePremier devices.

 **More details**

Please refer to Companion or Universe documentation.

20. Appendix: LINK

Link

The **Link feature** allows the creation of large setups, composed of up to 4 any LivePremier devices in a closed-circuit Leader and Followers configuration. All devices are managed as one unit from a single Web RCS of a Leader device.

The linked system can provide up to:

- 256 x 2K / Dual-resolution or 128 x 4K60p inputs
- 80 x 4K60p outputs
- 8 x 4K30p Multiviewers

Tip

When the Link feature is not needed, the dedicated slot can accommodate any standard output card, adding extra outputs to those already available on a device.

20.1. Link setup

Prerequisite

The **Link feature** requires an installation, in the last output slot, of:

- an embedded Link "host" card (performed by AW Service Center)
- an exchangeable Link connector card.

Cables required to connect a  1 Leader device with a  2 Follower device:

- two sets of 3, color-coded, DAC link cables with QSFP connectors
- one RJ45 cable (light blue on the diagram below).

Note

Each additional device requires a complementary set of 3 DAC link cables and an RJ45 cable.

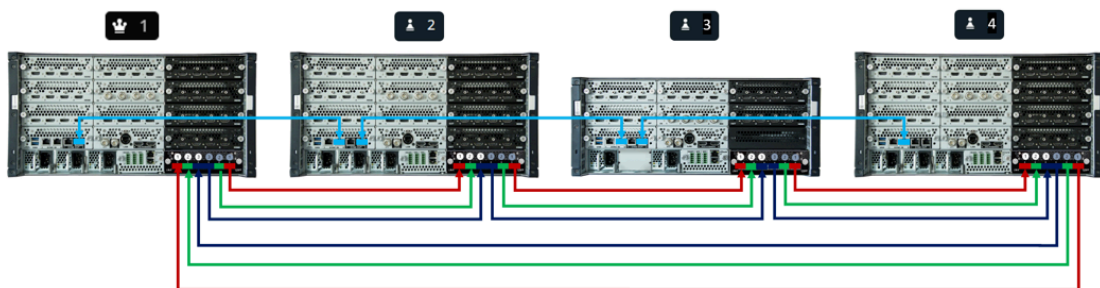

Example of connection diagram for linking a Leader device with Followers

20.1.1. Installation

Recommendation

Set up all devices on the same LAN network for Wake on LAN and for an easier access in case of troubleshooting.

Prerequisite

All devices must be using the same firmware version (v4.0 or above).

Caution

- The size of the Image Library cannot exceed 950MB.
- Do not use the synch or QSFP connectors with equipment other than Analog Way's.
- The device sync and QSFP connections do not require the device to be powered down, but disconnecting them when the device is running will result in disruption to the show and is to be avoided.

Procedure

1. Connect all units via an Ethernet cable linking an RJ45 **out connector 2** of one device to an RJ45 **in connector 2** of the following device (point to point).

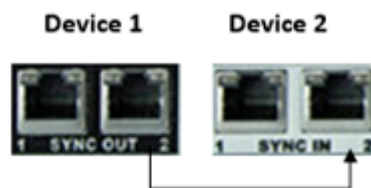

Ethernet cable connection

When properly connected, an orange LED (indicating connection speed) should be on and a green LED (indicating network activity) should be blinking.

2. Connect the Link connector cards of all devices via the DAC link cables, in daisy-chain to create a closed ring.

Note

The first and the last device must be within 3 meters maximum of each other (max length of DAC cables).

3. Connect the first outgoing connector of a Leader unit to the corresponding incoming connector of a Follower unit (**out 1 to in 1**) using one of the DAC cables.

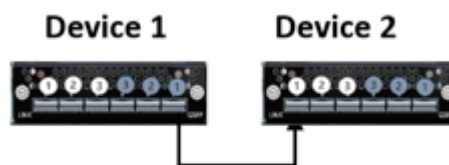

DAC cable connection

4. Repeat the operation with the other connectors: **out 2 to in 2** and **out 3 to in 3**.
5. Connect the following units in the same way up to the last device.
6. Connect the outgoing connectors of the last device to the corresponding incoming connectors of a Leader unit to close the loop: **out 1 to in 1**, **out 2 to in 2** and **out 3 to in 3**.

20.1.2. Configuration

The configuration is done using the WebRCS of a Leader device. The devices are identified by their serial numbers. They must be linked in the order corresponding to their actual placement in the Link chain.

1. In the WebRCS of a Leader, click on  and **Link Device**.
2. Select the Follower units from the dropdown list, adding them in the order corresponding to their physical connection.
3. Click **Check System** to verify if all devices are properly cabled and reconnect the cables displayed in red.
4. Click on **LINK SYSTEM** and confirm the configuration.
All the linked devices restart automatically to complete the configuration.
No additional Follower can be added to a running network.

Tip

Click on  to instantly see all linked devices in Device Overview and display the selected device's back panel.

OR

Click on **Dashboard** to display all of them simultaneously and enter the label for the Link system.

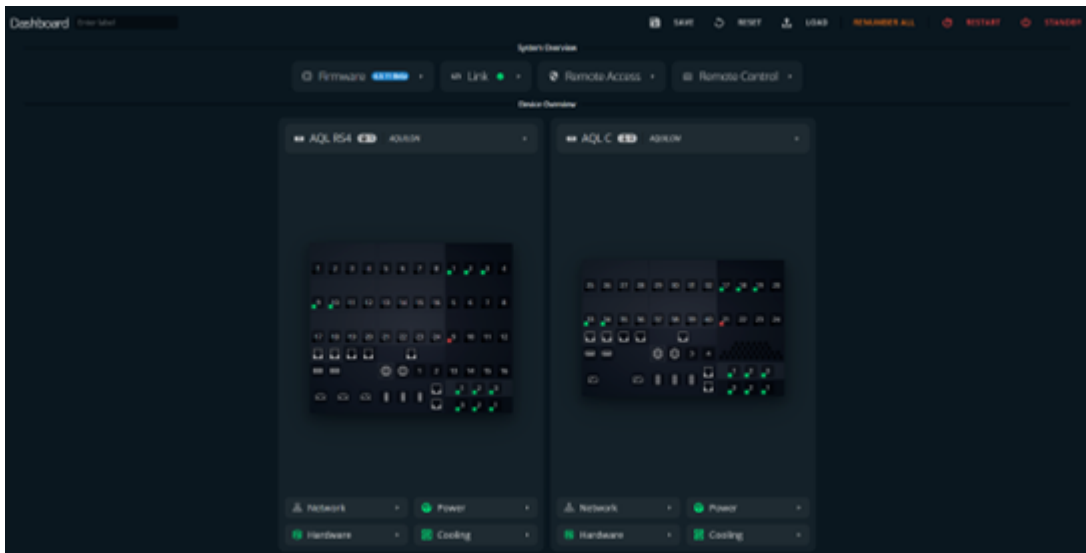

Link Dashboard

20.2. Share setup

The **Link feature** offers two types of sources:

- **Shared:** shared between the devices and available for multi-chassis use:
 - Up to 16 x 2K / Dual resolution or 8 x 4K inputs can be used as shared sources
 - Up to 48 image slots can be defined as shared
- **Local:** processed only on a device receiving the source.

Synchronisation

All devices must be on the same Link network to exchange data in real time and to synchronize the sources on a global level.

20.2.1. Shared sources setup

The sources must be defined as shared.

1. Go to **Preconfig> Inputs** or **Preconfig> Images**.
2. Select any input or an image slot of a Leader and enable **Share**.
The source is marked as Shared  and appears in the Shared sources section.

Sharing images

- Defining an image slot as shared, configures the corresponding slot on each Follower as shared and displays the same image.
- Shared image slots on the Followers are displayed as disabled.
- The number of available shared images slots depends on the number of IPUs of the smallest unit.

20.2.2. Global Multiviewer setup

Global Multiviewers (up to 2), available on a Leader device, can display the sources of all the linked devices and the multi-chassis Screens.

1. Go to **Preconfig> Multiviewer**.
2. Select a Multiviewer and enable **Global**.

Global Multiviewers capacities

- Enabling Global on a Multiviewer uses the resources of the Followers, disabling the first Multiviewer output on each Follower device.
- Multiviewer with capacity **2** preempts all other Multiviewer outputs.
- Multiviewer with capacity **1** displays 2 Global Multiviewers with capacity **1** or one Global and a Local on each linked device.
- Multiviewer can be duplicated on the same device.

20.2.3. Multi-chassis Screen setup

A screen can be composed of outputs of multiple devices. All outputs are treated as of one device and are assigned to one region by default.

A layer belonging to a multi-chassis region must use shared sources to be displayed properly on every output of this region.

Multi-chassis Screen sources use

- Local sources are only visible on the outputs of the device on which they are located.
- A background output can only use a local source.
- Audio channels from shared sources must be de-embedded locally and made available to Dante network for use on another chassis.

Tip

Use regions for an easier visibility of shared / local setups and to optimize the use of sources.

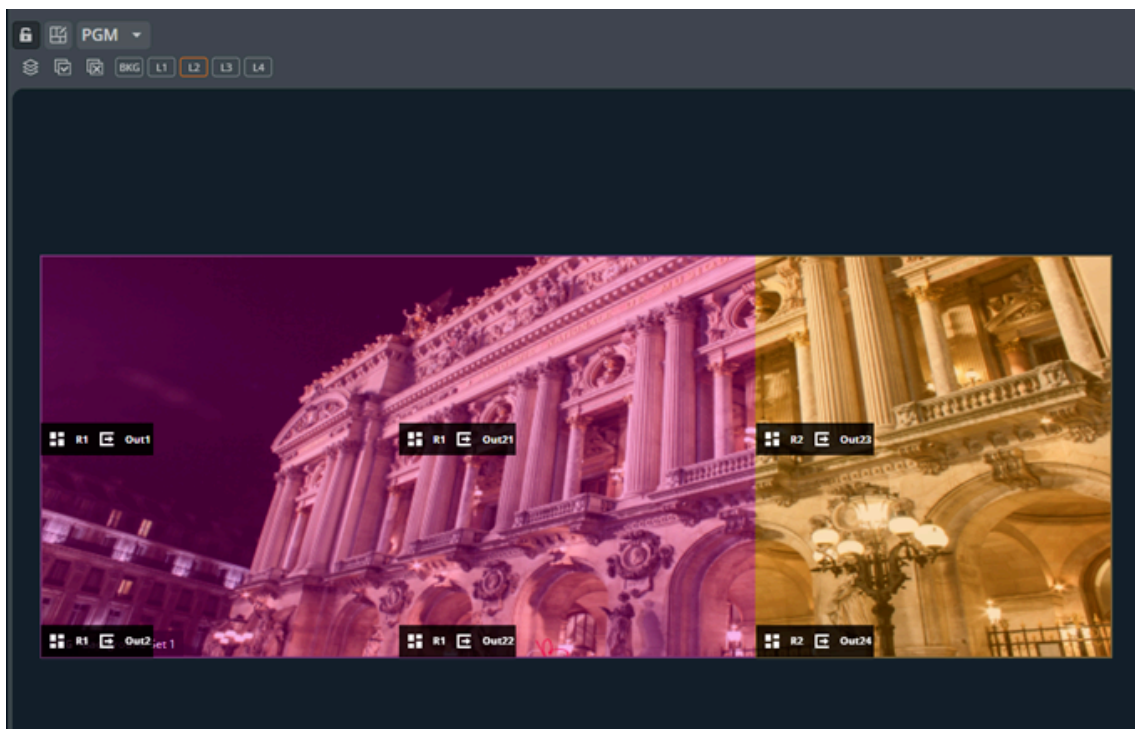

Example of a multi-chassis Screen setup with multi-chassis Region 1 and local Region 2

20.2.4. Settings

Settings (format, signal, aspect, etc.) are modified on the device where the source is located. The source location is indicated on the back panel.



Back panel of a Leader with three Followers

20.3. Linked system settings

20.3.1. Framelock

Only the SDI inputs from a Leader device can be used to synchronize the LivePremier system with an external reference.

Note

Computer timings are not supported.

20.3.2. Firmware update

The updater file extracted on the Leader machine is automatically sent to all the Followers and runs on each device in parallel. The Leader machine restarts when the entire system is updated.

Note

The Default reset can be launched from a Leader device for the entire system, breaking the link configuration.

20.3.3. Configuration import / export

Link configuration is saved on a Leader device. It includes the configuration of the Followers.

New set-up

When a Leader device is used in a new set-up or in a single mode, it requires a reconfiguration of sources. A Follower device returns to its previous, single mode settings.

20.3.4. Reset modes

Default Reset	<ul style="list-style-type: none"> • Link is lost. • Leader configuration is reset. • IP addresses, libraries (Images, Formats, EDIDs, etc.) and selected configurations are maintained.
Out of the box	<ul style="list-style-type: none"> • Link is lost. • Factory reset of the Leader (all settings are reset to default value). • Followers return to their previous configuration.

20.3.5. Power on and off

ON

Each device must be turned on within a 2 minute time-frame to maintain the Link configuration.

Wake on LAN

The activation of Wake on LAN feature for the Followers requires an external waking device connected to a switch through an Ethernet port. A Magic packet must be sent to each device.

OFF

Switching off the Leader unit sends command to all linked devices through Link network.

Front panel

Front panel shutdown can be initiated either on a Leader or a Follower unit.

20.3.6. Front panel

The front panel displays:

- the Link’s status
- the device information (Firmware, label and serial number)

To unlink a device, go to Control menu / Unlink System.

20.4. Navigation

For optimal visibility of the Link setup, it is recommended to display the Web RCS on an UltraWide screen (e.g. 2560 x 1440 or 5120 x 1440) and / or adjust the view using a zoom feature of the explorer.

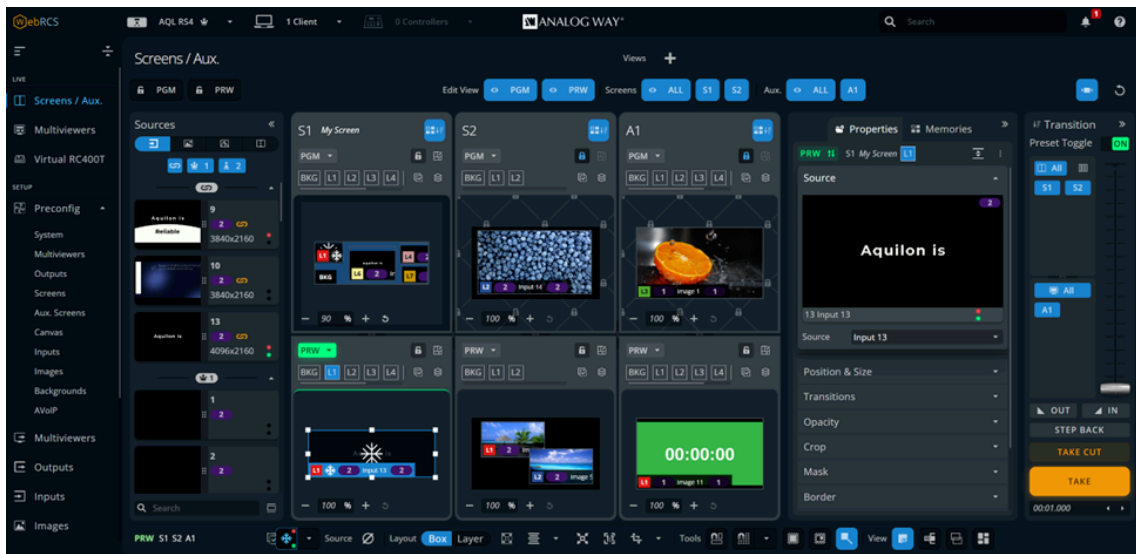

Live Screens / Aux. in Link setup

20.4.1. Screens display

The Link setup offers up to:

- 24 Screens
- 128 Mixing layers
- 80 Aux Screens

Tip

Resize the screens and use the view filters (see [Views](#) ^[p.140]) for more comfortable setting of your working space during setup.



20.4.2. Sources display

The Link setup offers up to:

- 256 inputs
- 192 still images

Filter options

Filter the available sources using the following options:

Selection button	Description
	Shared sources
	Leader device sources

	Followers sources
	Device not displayed in the list of sources
	Show / Hide device sources

Tip

Use the search bar at the bottom of the Sources panel to find a source or to display a batch of sources with the same char in the label.

20.5. Controllers

Analog Way controllers using USB port must be connected to the Leader device and activated on the WebRCS.

Note

- Presets are available for the first two Multiviewers.
- First 120 inputs are available.

20.6. Link troubleshooting

1. Go to **Dashboard > Link** if an error was reported.
The connection issues are identified in Cable Overview window.

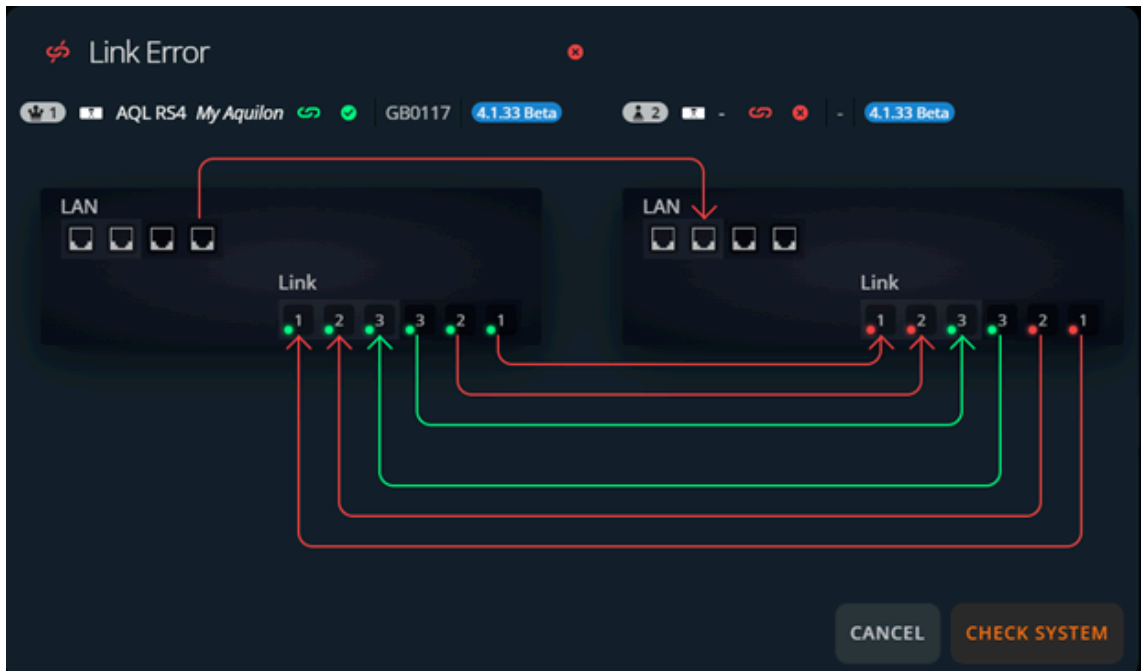

Cable Overview

2. Check the physical connection of the cable(s) in error and reconnect them properly.
The cable becomes orange in Cable overview.
3. Click **Check system** to verify if the communication between devices is valid.

 **Note**

- Checking the connection of QSFP cables takes a few seconds and may result in the outputs blink.
- Checking the connection of Ethernet cables requires the resynchronization of devices and will restart the system.

21. Contact information

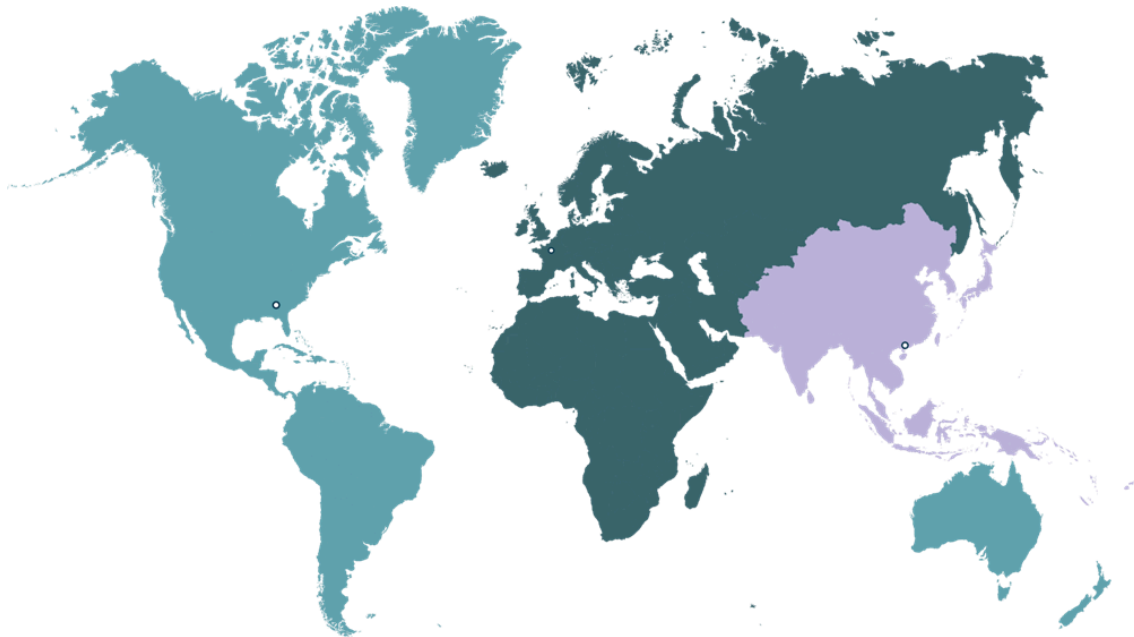

Analog Way Inc.

Tel.: +1 678 487 6644

3047 Summer Oak Place
Buford, GA 30518
USA

Sales/General information:
salesusa@analogway.com

Technical support:
techsupportnala@analogway.com

Analog Way SAS - Headquarters

Tel.: +33 (0)1 81 89 08 60

2/4 rue Georges Besse
92160 Antony
FRANCE

Sales/General information:
saleseuro@analogway.com

Technical support:
techsupport@analogway.com
Tel.: +33 (0)1 81 89 08 76

Analog Way Ltd

Tel.: +852 3960 7183

Office 1756, 17th Floor,
700 Nathan Road
Kowloon
Hong Kong

Sales/General information:
sales-apac@analogway.com

Technical support:
techsupport-apac@analogway.com

Glossary

Capacity	A capacity is the maximum bandwidth allocated to an item. Allocating a max capacity for every item ensures the interoperability between all the internal elements of a LivePremier unit. Capacities are automatically assigned when setting a format.
Image Processing Units <i>≈ IPU</i>	IPU components create the image content.
Input group	Grouping inputs optimizes the processing resources of the VPU and saves layers in Screens. It allows more inputs in the same VPU. It is possible to group up to four inputs together (ex. four 1920x1080 inputs can be used as one 3840x2160 source for a 4K output). <i>*Not supported for NDI inputs.</i>
Link	The Link feature allows the creation of large setups, composed of up to 4 any LivePremier devices in a closed-circuit Leader and Followers configuration. All devices are managed as one unit from a single Web RCS of a Leader device.
Mixing layers	This is the default layer mode for LivePremier units as well as most Analog Way products. Mixing layers support cross transitions with both contents visible at the same time during the transition (seamless transition).
Multiviewer	A Multiviewer is a dedicated output displaying a user customizable selection of Widgets as display resources to monitor content. One Multiviewer can display up to 64 Widgets. A Widget is a Multiviewer layer containing a program, preview, input, image or timer.
Output group	Grouping outputs optimizes the processing resources of the VPU for Screens with multiple outputs. It allows the use of more outputs in the same VPU (ex. one VPU can manage up to 16 outputs in four 2x2 Screens).
Split layers	This layer mode consumes half the processing resources compared to mixing layers and doubles the number of layers available on Screen. Split layers are created by pairs with same resource consumption (capacity 1 or 2 , use of Cut & Fill).

Vertical rate

Sets the overall internal operating frame rate of the unit, which defines the frame rate of all Program outputs.

Vertical rate can be set manually, or by following a Genlock or Framelock as a reference.

Video Processing Units
≈ VPU

VPU are the main processing components of LivePremier. They create the layers and allocate them to one or multiple outputs.
